



REPLENISH
— *Big Bear* —

2/28/2022

Jayne Joy

Executive Officer

Santa Ana Regional Water Quality Control Board

3737 Main Street, Suite 500

Riverside, CA 92501

Delivered via Email

Subject: Report of Waste Discharge for Big Bear Area Regional Wastewater Agency Regional Treatment Plant (Replenish Big Bear)

Dear Ms. Joy,

On behalf of Replenish Big Bear project team, please find attached the Report of Waste Discharge (ROWD) for Big Bear Area Regional Wastewater Agency (BBARWA) Regional Treatment Plant. This ROWD is to request a National Pollutant Discharge Elimination System (NPDES) permit for two new discharge locations at 1) to Stanfield Marsh Wildlife and Waterfowl Preserve (Stanfield Marsh), a tributary of Big Bear Lake (Lake) and 2) a separate discharge to Shay Pond, a tributary of Shay Creek.

BBARWA has partnered with Big Bear City Community Service District (BBCCSD), Big Bear Lake Department of Water and Power (BBLDWP), Big Bear Municipal Water District (BBMWD), and Bear Valley Basin Groundwater Sustainability Agency (BVBGSA), collectively known as the Agency Team, to develop the Replenish Big Bear Program. The Replenish Big Bear Program is intended to help protect the Big Bear Valley (Valley) and the Santa Ana Watershed from the impacts of drought and variable precipitation by recovering a water resource currently discharged outside of the watershed. The program is comprised of several elements; the first project includes treatment upgrades at the BBARWA regional wastewater treatment plant (WWTP) to produce disinfected, advanced treated effluent by providing tertiary filtration, reverse osmosis (RO) treatment, and ultraviolet (UV) disinfection for 100% of the water proposed to be discharged at the two new locations.

The proposed project and subject of this ROWD is the discharge of disinfected, advanced treated BBARWA effluent to (1) Stanfield Marsh/Big Bear Lake at a discharge rate up to 2,210 AFY and (2) Shay Pond at a discharge rate up to 80 AFY, is determined to comprise best practicable treatment and control and is consistent with federal and state antidegradation policies. The information supporting this finding is provided in the ROWD submittal package, which consists of the following:

I. ROWD Forms



Service, Quality, Community

BIG BEAR CITY
CSD
Community Service District #10

- California EPA Form 200
- NPDES Form 2A
- NPDES Form 2S
- Location Maps
- Treatment Process Description

II. Supplemental Information

- Attachment A. Secondary Effluent and Receiving Water Characterization Data
- Attachment B. Technical Memo: Approach to Address Big Bear Lake Nutrient Total Maximum Daily Load in the NPDES Permit for Big Bear Area Regional Wastewater Agency
- Attachment C. Antidegradation Analysis for Proposed Discharges to Stanfield Marsh/Big Bear Lake and Shay Pond

Note that BBARWA previously held an NPDES permit for discharge to Stanfield Marsh (Order No. 00-12 NPDES No. CA8000344), which was replaced with Waste Discharge Requirements (WDRs) in 2005 because the discharge point was not being used. This expired NPDES number is included in the ROWD forms for reference.

We look forward to further engaging with you and your team on this project and are committed to working cooperatively to implement *Replenish Big Bear* to benefit the Big Bear Valley as well as the greater Santa Ana River Watershed.

Following your review of this ROWD submittal, we would like to request a meeting with key members of your team to discuss any feedback or requests for additional information so that the project team can respond as quickly as possible to keep this critical project moving forward.

We look forward to your review and feedback for next steps. If you have any questions in the meantime, please call or email me at the contact information listed below.

Sincerely,



David Lawrence, PE
General Manager
Big Bear Area Regional Wastewater Agency
dlawrence@bbarwa.org
Mobile: (818) 581-1561



Cc:

SantaAna@waterboards.ca.gov

Julio Lara, Santa Ana Water Board (Julio.Lara@waterboards.ca.gov)

Ryan Harris, Santa Ana Water Board (Ryan.Harris@Waterboards.ca.gov)

Susan Beeson, Santa Ana Water Board (susan.beeson@waterboards.ca.gov)

Lauma Willis, Santa Ana Water Board (Lauma.Willis@waterboards.ca.gov)

John Shimmin, Big Bear Area Regional Wastewater Agency (JShimmin@BBARWA.org)

Mary Reeves, Big Bear City Community Services District (mreeves@bbccsd.org)

Mike Stephenson, Big Bear Municipal Water District (MikeStephenson@bbmwd.net)

Reggie Lamson, Big Bear Lake Department of Water and Power
(RLamson@bbldwp.com)

Laine Carlson, Water Systems Consulting (lcarlson@wsc-inc.com)

Antonia Estevez-Olea, Water Systems Consulting (aestevezolea@wsc-inc.com)

Matt Rodrigues, Water Systems Consulting (mrodrigues@wsc-inc.com)

Jeffery Szytel, Water Systems Consulting (jszytel@wsc-inc.com)

Ashli Desai, Larry Walker Associates (ashlid@lwa.com)

Betsy Elzufon, Larry Walker Associates (betsye@lwa.com)

Mike Trouchon, Larry Walker Associates (michaelt@lwa.com)

Michael A Anderson (michael.anderson@ucr.edu)

Enclosures





REPLENISH
— Big Bear —

Report of Waste Discharge for Big Bear Area Regional Wastewater Agency Regional Treatment Plant

Prepared by:
Water Systems Consulting, Inc &
Larry Walker Associates

February 2021



Acknowledgement of Credit

This report is financed under the Water Quality, Supply and Infrastructure Improvement Act of 2014, administered by the State of California, Department of Water Resources.



This page was intentionally left blank

Table of Contents

I. California EPA Form 200

II. NPDES Form 2A

- Section 1 – Basic Information
- Section 2 – Additional Information
- Section 3 – Effluent Discharges
- Section 4 – Industrial Discharges (not applicable)
- Section 5 – Combined Sewer Overflows (not applicable)
- Section 6 – Checklist and Certification Statement

III. NPDES Form 2S

- Part 2, Section 1 – General Information
- Part 2, Section 2 – Generation of Sewage Sludge
- Part 2, Section 3 – Land Application (not applicable)
- Part 2, Section 4 – Surface Disposal (not applicable)
- Part 2, Section 5 – Incineration (not applicable)

IV. Location Maps

V. Treatment Processes

VI. Supplemental Information

Attachment A. Secondary Effluent and Receiving Water Characterization Data

Attachment B. Approach to Address Big Bear Lake Nutrient Total Maximum Daily
Load in the NPDES Permit for Big Bear Area Regional Wastewater Agency

Attachment C. Antidegradation Analysis for Proposed Discharges to Stanfield Marsh/Big
Bear Lake and Shay Pond

I. California EPA Form 200



State of California
Regional Water Quality Control Board

APPLICATION/REPORT OF WASTE DISCHARGE
GENERAL INFORMATION FORM FOR
WASTE DISCHARGE REQUIREMENTS OR NPDES PERMIT

I. FACILITY INFORMATION

A. FACILITY:

Name Regional Treatment Plant, Big Bear City
Address 122 Palomino Drive
City/County/State/Zip Code Big Bear City, CA 92314
Contact Person John Shimmin, Plant Manager
Telephone Number (909) 584-4520 Email JShimmin@BBARWA.org

B. FACILITY OWNER:

Name Big Bear Area Regional Wastewater Agency
Address 121 Palomino Drive, P.O. Box 517
City/State/Zip Code Big Bear City, CA 92314
Contact Person David Lawrence, General Manager
Telephone Number (909) 584-4521 Email dlawrence@bbarwa.org
Federal Tax ID 33-0186735

Owner Type (Mark one):

- Individual Corporation Governmental Agency Partnership Other:

C. FACILITY OPERATOR (The agency or business, not the person):

Name Big Bear Area Regional Wastewater Agency
Address 121 Palomino Drive, P.O. Box 517
City/State/Zip Code Big Bear City, CA 92314
Contact Person John Shimmin, Plant Manager
Telephone Number (909) 584-4520 Email JShimmin@BBARWA.org

Operator Type (Mark one):

- Individual Corporation Governmental Agency Partnership Other:

D. OWNER OF THE LAND

Name Big Bear Area Regional Wastewater Agency

Address 121 Palomino Drive, P.O. Box 517

City/State/Zip Code Big Bear City, CA 92314

Contact Person David Lawrence, General Manager

Telephone Number (909) 584-4521 Email dlawrence@bbarwa.org

Owner Type (*Mark one*):

- Individual
- Corporation
- Governmental Agency
- Partnership
- Other: _____

E. ADDRESS WHERE LEGAL NOTICE MAY BE SERVED

Address 121 Palomino Drive, P.O. Box 517

City/State/Zip Code Big Bear City, CA 92314

Contact Person David Lawrence, General Manager

Telephone Number (909) 584-4521 Email dlawrence@bbarwa.org

F. BILLING ADDRESS

Address 121 Palomino Drive, P.O. Box 517

City/State/Zip Code Big Bear City, CA 92314

Contact Person Sonja Kawa

Telephone Number (909) 584-4523 Email skawa@bbarwa.org

II. TYPE OF DISCHARGE

Check Type of Discharge(s) Described in this Application:

- Waste Discharge to Land**
- Waste Discharge to Surface Water**

Check all that apply:

- Animal or Aquacultural Wastewater
- Animal Waste Solids
- Biosolids/Residual
- Cooling Water
- Domestic/ Municipal Wastewater Treatment and Disposal
- Dredge Material Disposal
- Hazardous Waste (*see instructions*)
- Industrial Process Wastewater
- Land Treatment Unit
- Landfill (*see instructions*)
- Mining
- Storm Water
- Surface Impoundment
- Waste Pile
- Wastewater Reclamation
- Other, *please describe* _____

III. LOCATION OF THE FACILITY

Describe the physical location of the facility:

1. Assessor's Parcel Number(s)

Facility: 0449-082-040000

Discharge Point: N/A

2. Latitude

Facility: 34° 16' 4.2" N

Discharge Point: 34° 15' 46.5" N (Stanfield Marsh), 34° 15' 14.7"N (Shay Pond)

3. Longitude

Facility: 116° 48' 55.6" W

Discharge Point: 116° 51' 58.9" W (Stanfield Marsh), 116° 48' 30.2"W (Shay Pond)

IV. REASON FOR FILING

Check all that apply:

- New Discharge or Facility
- Change in Design or Operation
- Change in Quantity/Type of Discharge
- Changes in Ownership/Operator (see instructions)
- Waste Discharge Requirements Update or NPDES Permit Reissuance
- Other: _____

V. CALIFORNIA ENVIRONMENTAL QUALITY ACT (CEQA)

Name of Lead Agency Big Bear Area Regional Wastewater Agency

Has a public agency determined that the proposed project is exempt from CEQA?

- Yes
- No

If yes, state the basis for the exemption and the name of the agency supplying the exemption on the line below:

Has a "Notice of Determination" been filed under CEQA?

- Yes
- No

If Yes, enclose a copy of the CEQA document, Environmental Impact Report (EIR), or Negative Declaration. If No, identify the expected type of CEQA document and expected date of completion.

Expected CEQA Documents: EIR Negative Declaration

Expected CEQA Completion Date: June 2023

VI. OTHER REQUIRED INFORMATION

Please provide a COMPLETE characterization of your discharge. A complete characterization includes, but is not limited to, design and actual flows, a list of constituents and the discharge concentration of each constituent, a list of other appropriate waste discharge characteristics, a description and schematic drawing of all treatment processes, a description of any Best Management Practices (BMPs) used, and a description of disposal methods.

Also include a site map showing the location of the facility and, if you are submitting this application for an NPDES permit, identify the surface water to which you propose to discharge. Please try to limit your maps to a scale of 1:24,000 (7.5' USGS Quadrangle) or a street map, if more appropriate.

VII. OTHER

Attach additional sheets to explain any responses which need clarification. List attachments with titles and dates below:

NPDES Forms 2A and 2S, facility maps (January 2022), treatment process narrative and schematics.

You will be notified by a representative of the RWQCB within 30 days of receipt of your application. The notice will state if your application is complete or if there is additional information you must submit to complete your Application/Report of Waste Discharge, pursuant to Division 7, Section 13260 of the California Water Code.

VIII. CERTIFICATION

"I certify under penalty of law that this document, including all attachments and supplemental information, were prepared under my direction and supervision in accordance with a system designed to assure that qualified personnel properly gathered and evaluated the information submitted. Based on my inquiry of the person or persons who manage the system, or those persons directly responsible for gathering the information, the information submitted is, to the best of my knowledge and belief, true, accurate, and complete. I am aware that there are significant penalties for submitting false information, including the possibility of fine and imprisonment."

Print Name David Lawrence Title General Manager

Signature  Date 2/28/2022

FOR OFFICE USE ONLY

Date Form 200 Received:	Letter to Discharger:	Fee Amount Received:	Check #:
-------------------------	-----------------------	----------------------	----------

II. NPDES Form 2A

Section 1 – Basic Information

Section 2 – Additional Information

Section 3 – Effluent Discharges

Section 4 – Industrial Discharges (not applicable)

Section 5 – Combined Sewer Overflows (not applicable)

Section 6 – Checklist and Certification Statement

EPA Identification Number		NPDES Permit Number CA8000344		Facility Name Big Bear City RTP		Form Approved 03/05/19 OMB No. 2040-0004		
Form 2A NPDES		U.S. Environmental Protection Agency Application for NPDES Permit to Discharge Wastewater NEW AND EXISTING PUBLICLY OWNED TREATMENT WORKS						
SECTION 1. BASIC APPLICATION INFORMATION FOR ALL APPLICANTS (40 CFR 122.21(j)(1) and (9))								
Facility Information	1.1	Facility name Regional Treatment Plant, Big Bear City						
		Mailing address (street or P.O. box) 121 Palomino Drive, P.O. Box 517						
		City or town Big Bear City		State CA		ZIP code 92314		
		Contact name (first and last) John Shimmin		Title Plant Manager		Phone number (909) 584-4520		
		Email address JShimmin@BBARWA.org		Location address (street, route number, or other specific identifier) <input type="checkbox"/> Same as mailing address 122 Palomino Drive				
		City or town Big Bear City		State CA		ZIP code 92314		
	1.2	Is this application for a facility that has yet to commence discharge? <input checked="" type="checkbox"/> Yes → See instructions on data submission requirements for new dischargers. <input type="checkbox"/> No <i>The existing facility was issued an NPDES permit for discharge to surface water which expired February 1, 2005. The facility is planning upgrades which will entirely change the discharge quality.</i>						
Applicant Information	1.3	Is applicant different from entity listed under Item 1.1 above? <input checked="" type="checkbox"/> Yes <input type="checkbox"/> No → SKIP to Item 1.4.						
		Applicant name Big Bear Area Regional Wastewater Agency						
		Applicant address (street or P.O. box) 121 Palomino Drive, P.O. Box 517						
		City or town Big Bear City		State CA		ZIP code 92314		
		Contact name (first and last) David Lawrence		Title General Manager		Phone number (909) 584-4521		
	Email address dlawrence@bbarwa.org							
	1.4	Is the applicant the facility's owner, operator, or both? (Check only one response.) <input type="checkbox"/> Owner <input type="checkbox"/> Operator <input checked="" type="checkbox"/> Both						
	1.5	To which entity should the NPDES permitting authority send correspondence? (Check only one response.) <input type="checkbox"/> Facility <input checked="" type="checkbox"/> Applicant <input type="checkbox"/> Facility and applicant (they are one and the same)						
Existing Environmental Permits	1.6	Indicate below any existing environmental permits. (Check all that apply and print or type the corresponding permit number for each.)						
		Existing Environmental Permits						
		<input checked="" type="checkbox"/> NPDES (discharges to surface water) [See note below] CA8000344		<input type="checkbox"/> RCRA (hazardous waste)		<input type="checkbox"/> UIC (underground injection control)		
		<input type="checkbox"/> PSD (air emissions)		<input type="checkbox"/> Nonattainment program (CAA)		<input type="checkbox"/> NESHAPs (CAA)		
	<input type="checkbox"/> Ocean dumping (MPRSA)		<input type="checkbox"/> Dredge or fill (CWA Section 404)		<input checked="" type="checkbox"/> Other (specify) WDR: R8-2005-0044 WDR: R7-2021-0023			

Note: This NPDES permit for discharge to surface water expired February 1, 2005.

EPA Identification Number		NPDES Permit Number CA8000344		Facility Name Big Bear City RTP		Form Approved 03/05/19 OMB No. 2040-0004	
Collection System and Population Served	1.7	Provide the collection system information requested below for the treatment works. [USCB 2019, from Google]					
		Municipality Served	Population Served	Collection System Type (indicate percentage)		Ownership Status	
		Big Bear City CSD	13,463	<u>100</u> % separate sanitary sewer <u>0</u> % combined storm and sanitary sewer <input type="checkbox"/> Unknown	<input checked="" type="checkbox"/> Own <input type="checkbox"/> Own <input type="checkbox"/> Own	<input checked="" type="checkbox"/> Maintain <input type="checkbox"/> Maintain <input type="checkbox"/> Maintain	
		City of Big Bear Lake	5,241	<u>100</u> % separate sanitary sewer <u>0</u> % combined storm and sanitary sewer <input type="checkbox"/> Unknown	<input checked="" type="checkbox"/> Own <input type="checkbox"/> Own <input type="checkbox"/> Own	<input checked="" type="checkbox"/> Maintain <input type="checkbox"/> Maintain <input type="checkbox"/> Maintain	
		San Bernardino County SA 53-B	Estimated 650	<u>100</u> % separate sanitary sewer <u>0</u> % combined storm and sanitary sewer <input type="checkbox"/> Unknown	<input checked="" type="checkbox"/> Own <input type="checkbox"/> Own <input type="checkbox"/> Own	<input checked="" type="checkbox"/> Maintain <input type="checkbox"/> Maintain <input type="checkbox"/> Maintain	
		BBARWA regional collection facilities	0	<u> </u> % separate sanitary sewer <u> </u> % combined storm and sanitary sewer <input type="checkbox"/> Unknown	<input checked="" type="checkbox"/> Own <input type="checkbox"/> Own <input type="checkbox"/> Own	<input checked="" type="checkbox"/> Maintain <input type="checkbox"/> Maintain <input type="checkbox"/> Maintain	
		Total Population Served	19,354				
		Total percentage of each type of sewer line (in miles)		Separate Sanitary Sewer System	Combined Storm and Sanitary Sewer		
			100 %	0 %			
Indian Country	1.8	Is the treatment works located in Indian Country? <input type="checkbox"/> Yes <input checked="" type="checkbox"/> No					
	1.9	Does the facility discharge to a receiving water that flows through Indian Country? <input type="checkbox"/> Yes <input checked="" type="checkbox"/> No					
Design and Actual Flow Rates	1.10	Provide design <i>and</i> actual flow rates in the designated spaces.				Design Flow Rate	
						4.89 mgd	
		Annual Average Flow Rates (Actual)					
		Two Years Ago		Last Year		This Year	
		2.22 mgd		1.96 mgd		1.84 mgd	
		Maximum Daily Flow Rates (Actual)					
Two Years Ago		Last Year		This Year			
8.39 mgd		4.56 mgd		3.18 mgd			
Discharge Points by Type	1.11	Provide the total number of effluent discharge points to waters of the United States by type.					
		Total Number of Effluent Discharge Points by Type					
		Treated Effluent	Untreated Effluent	Combined Sewer Overflows	Bypasses	Constructed Emergency Overflows	
	2 proposed						

Outfalls and Other Discharge or Disposal Methods

Outfalls Other Than to Waters of the United States

1.12 Does the POTW discharge wastewater to basins, ponds, or other surface impoundments that do not have outlets for discharge to waters of the United States?
 Yes No → SKIP to Item 1.14.

1.13 Provide the location of each surface impoundment and associated discharge information in the table below.

Surface Impoundment Location and Discharge Data		
Location	Average Daily Volume Discharged to Surface Impoundment	Continuous or Intermittent (check one)
Lucerne Valley reservoir (Colorado River Basin RWB)	2,120,000 gpd	<input checked="" type="checkbox"/> Continuous <input type="checkbox"/> Intermittent <i>See Note below</i>
	gpd	<input type="checkbox"/> Continuous <input type="checkbox"/> Intermittent
	gpd	<input type="checkbox"/> Continuous <input type="checkbox"/> Intermittent

1.14 Is wastewater applied to land?
 Yes No → SKIP to Item 1.16.

1.15 Provide the land application site and discharge data requested below.

Land Application Site and Discharge Data			
Location	Size	Average Daily Volume Applied	Continuous or Intermittent (check one)
Lucerne Valley, CA-247 and Camp Rock Rd	340 acres	<i>See Note below</i> 2,120,000 gpd	<input checked="" type="checkbox"/> Continuous <input type="checkbox"/> Intermittent
	acres	gpd	<input type="checkbox"/> Continuous <input type="checkbox"/> Intermittent
	acres	gpd	<input type="checkbox"/> Continuous <input type="checkbox"/> Intermittent

1.16 Is effluent transported to another facility for treatment prior to discharge?
 Yes No → SKIP to Item 1.21.

1.17 Describe the means by which the effluent is transported (e.g., tank truck, pipe).

1.18 Is the effluent transported by a party other than the applicant?
 Yes No → SKIP to Item 1.20.

1.19 Provide information on the transporter below.

Transporter Data	
Entity name	Mailing address (street or P.O. box)
City or town	State ZIP code
Contact name (first and last)	Title
Phone number	Email address

Note: After treatment upgrades, up to 2.2 MGD of treated effluent will be sent to outfalls and only any additional flow will be sent to the Lucerne Valley reservoir surface impoundment or land application (permitted under the WDRs).

EPA Identification Number		NPDES Permit Number CA8000344		Facility Name Big Bear City RTP		Form Approved 03/05/19 OMB No. 2040-0004	
Outfalls and Other Discharge or Disposal Methods Continued	1.20	In the table below, indicate the name, address, contact information, NPDES number, and average daily flow rate of the receiving facility.					
	Receiving Facility Data						
	Facility name			Mailing address (street or P.O. box)			
	City or town			State		ZIP code	
	Contact name (first and last)			Title			
	Phone number			Email address			
	NPDES number of receiving facility (if any) <input type="checkbox"/> None			Average daily flow rate mgd			
	1.21	Is the wastewater disposed of in a manner other than those already mentioned in Items 1.14 through 1.21 that do not have outlets to waters of the United States (e.g., underground percolation, underground injection)? <input type="checkbox"/> Yes <input checked="" type="checkbox"/> No → SKIP to Item 1.23.					
Outfalls and Other Discharge or Disposal Methods Continued	1.22	Provide information in the table below on these other disposal methods.					
	Information on Other Disposal Methods						
		Disposal Method Description	Location of Disposal Site	Size of Disposal Site	Annual Average Daily Discharge Volume	Continuous or Intermittent (check one)	
				acres	gpd	<input type="checkbox"/> Continuous <input type="checkbox"/> Intermittent	
				acres	gpd	<input type="checkbox"/> Continuous <input type="checkbox"/> Intermittent	
			acres	gpd	<input type="checkbox"/> Continuous <input type="checkbox"/> Intermittent		
Variance Requests	1.23	Do you intend to request or renew one or more of the variances authorized at 40 CFR 122.21(n)? (Check all that apply. Consult with your NPDES permitting authority to determine what information needs to be submitted and when.) <input type="checkbox"/> Discharges into marine waters (CWA Section 301(h)) <input type="checkbox"/> Water quality related effluent limitation (CWA Section 302(b)(2)) <input checked="" type="checkbox"/> Not applicable					
Contractor Information	1.24	Are any operational or maintenance aspects (related to wastewater treatment and effluent quality) of the treatment works the responsibility of a contractor? <input type="checkbox"/> Yes <input checked="" type="checkbox"/> No → SKIP to Section 2.					
	1.25	Provide location and contact information for each contractor in addition to a description of the contractor's operational and maintenance responsibilities.					
	Contractor Information						
			Contractor 1	Contractor 2	Contractor 3		
		Contractor name (company name)					
		Mailing address (street or P.O. box)					
		City, state, and ZIP code					
		Contact name (first and last)					
		Phone number					
	Email address						
	Operational and maintenance responsibilities of contractor						

SECTION 2. ADDITIONAL INFORMATION (40 CFR 122.21(j)(1) and (2))

Design Flow	Outfalls to Waters of the United States					
	2.1	Does the treatment works have a design flow greater than or equal to 0.1 mgd? <input checked="" type="checkbox"/> Yes <input type="checkbox"/> No → SKIP to Section 3.				
Inflow and Infiltration	2.2	Provide the treatment works' current average daily volume of inflow and infiltration.	Average Daily Volume of Inflow and Infiltration			
			(Difference between wet and dry season influent flow between 2016-2021). 598,000 gpd			
		Indicate the steps the facility is taking to minimize inflow and infiltration. Only the 18" and 20" trunk lines and force main pump station are the responsibility of the applicant. Video inspection is performed every four years. The most recent inspection identified seven areas that will require maintenance within 5-10 years.				
Topographic Map	2.3	Have you attached a topographic map to this application that contains all the required information? (See instructions for specific requirements.) <input checked="" type="checkbox"/> Yes <input type="checkbox"/> No				
Flow Diagram	2.4	Have you attached a process flow diagram or schematic to this application that contains all the required information? (See instructions for specific requirements.) <input checked="" type="checkbox"/> Yes <input type="checkbox"/> No				
Scheduled Improvements and Schedules of Implementation	2.5	Are improvements to the facility scheduled? <input checked="" type="checkbox"/> Yes <input type="checkbox"/> No → SKIP to Section 3.				
	Briefly list and describe the scheduled improvements.					
	1. See the Treatment Process Narrative (Section V).					
	2.					
	3.					
	4.					
	2.6	Provide scheduled or actual dates of completion for improvements.				
Scheduled or Actual Dates of Completion for Improvements						
	Scheduled Improvement (from above)	Affected Outfalls (list outfall number)	Begin Construction (MM/DD/YYYY)	End Construction (MM/DD/YYYY)	Begin Discharge (MM/DD/YYYY)	Attainment of Operational Level (MM/DD/YYYY)
	1.	001, 002		06/30/2026	07/01/2026	
	2.					
	3.					
	4.					
2.7	Have appropriate permits/clearances concerning other federal/state requirements been obtained? Briefly explain your response. <input type="checkbox"/> Yes <input checked="" type="checkbox"/> No <input type="checkbox"/> None required or applicable					
Explanation: All required federal permits will be obtained before construction begins.						

EPA Identification Number	NPDES Permit Number CA8000344	Facility Name Big Bear City RTP
---------------------------	----------------------------------	------------------------------------

Form Approved 03/05/19
OMB No. 2040-0004

SECTION 3. INFORMATION ON EFFLUENT DISCHARGES (40 CFR 122.21(j)(3) to (5))

Description of Outfalls	3.1	Provide the following information for each outfall. (Attach additional sheets if you have more than three outfalls.)		
		Outfall Number <u>001</u>	Outfall Number <u>002</u>	Outfall Number _____
	State	CA	CA	
	County	San Bernardino	San Bernardino	
	City or town	Big Bear City	Big Bear City	
	Distance from shore	N/A ft.	N/A ft.	ft.
	Depth below surface	N/A ft.	N/A ft.	ft.
	Average daily flow rate	2.2 mgd	0.0714 mgd	mgd
	Latitude	34° 15' 46.5" N	34° 15' 14.7" N	° ' "
	Longitude	116° 51' 58.9" W	116° 48' 30.2" W	° ' "
Seasonal or Periodic Discharge Data	3.2	Do any of the outfalls described under Item 3.1 have seasonal or periodic discharges? <input type="checkbox"/> Yes <input checked="" type="checkbox"/> No → SKIP to Item 3.4.		
	3.3	If so, provide the following information for each applicable outfall.		
		Outfall Number _____	Outfall Number _____	Outfall Number _____
	Number of times per year discharge occurs			
	Average duration of each discharge (specify units)			
	Average flow of each discharge	mgd	mgd	mgd
Months in which discharge occurs				
Diffuser Type	3.4	Are any of the outfalls listed under Item 3.1 equipped with a diffuser? <input type="checkbox"/> Yes <input checked="" type="checkbox"/> No → SKIP to Item 3.6.		
	3.5	Briefly describe the diffuser type at each applicable outfall.		
		Outfall Number _____	Outfall Number _____	Outfall Number _____
Waters of the U.S.	3.6	Does the treatment works discharge or plan to discharge wastewater to waters of the United States from one or more discharge points? <input checked="" type="checkbox"/> Yes <input type="checkbox"/> No → SKIP to Section 6.		

EPA Identification Number		NPDES Permit Number CA8000344		Facility Name Big Bear City RTP		Form Approved 03/05/19 OMB No. 2040-0004	
Receiving Water Description	3.7	Provide the receiving water and related information (if known) for each outfall.					
			Outfall Number <u>001</u>	Outfall Number <u>002</u>	Outfall Number _____		
	Receiving water name	Stanfield Marsh	Shay Pond [See Note below]				
	Name of watershed, river, or stream system	Big Bear Lake	Shay Creek				
	U.S. Soil Conservation Service 14-digit watershed code	341429116583101	N/A				
	Name of state management/river basin	N/A	N/A				
	U.S. Geological Survey 8-digit hydrologic cataloging unit code	N/A	N/A				
	Critical low flow (acute)	N/A cfs	N/A cfs	cfs			
	Critical low flow (chronic)	N/A cfs	N/A cfs	cfs			
	Total hardness at critical low flow	157 mg/L of CaCO ₃	180 (1 value) mg/L of CaCO ₃	mg/L of CaCO ₃			
Treatment Description	3.8	Provide the following information describing the treatment provided for discharges from each outfall.					
			Outfall Number <u>001</u>	Outfall Number <u>002</u>	Outfall Number _____		
	Highest Level of Treatment (check all that apply per outfall)	<input checked="" type="checkbox"/> Primary <input type="checkbox"/> Equivalent to secondary <input checked="" type="checkbox"/> Secondary <input checked="" type="checkbox"/> Advanced <input checked="" type="checkbox"/> Other (specify) <u>Tertiary, NDN, RO</u>	<input checked="" type="checkbox"/> Primary <input type="checkbox"/> Equivalent to secondary <input checked="" type="checkbox"/> Secondary <input checked="" type="checkbox"/> Advanced <input checked="" type="checkbox"/> Other (specify) <u>Tertiary, NDN, RO</u>	<input type="checkbox"/> Primary <input type="checkbox"/> Equivalent to secondary <input type="checkbox"/> Secondary <input type="checkbox"/> Advanced <input type="checkbox"/> Other (specify) _____			
	Design Removal Rates by Outfall	Anticipated values for the proposed treatment level:					
	BOD ₅ or CBOD ₅	99 %	99 %	%			
	TSS	99 %	99 %	%			
	Phosphorus	<input type="checkbox"/> Not applicable 99 %	<input type="checkbox"/> Not applicable 99 %	<input type="checkbox"/> Not applicable %			
	Nitrogen	<input type="checkbox"/> Not applicable 98 %	<input type="checkbox"/> Not applicable 98 %	<input type="checkbox"/> Not applicable %			
Other (specify) Total dissolved solids	<input type="checkbox"/> Not applicable 88 %	<input type="checkbox"/> Not applicable 88 %	<input type="checkbox"/> Not applicable %				

Note: The status of Shay Pond as a water of the U.S. has yet to be determined.

Treatment Description Continued	3.9	Describe the type of disinfection used for the effluent from each outfall in the table below. If disinfection varies by season, describe below.						
			Outfall Number <u>001</u>	Outfall Number <u>002</u>	Outfall Number _____			
		Disinfection type	Ultraviolet light	Ultraviolet light				
		Seasons used	All	All				
		Dechlorination used?	<input checked="" type="checkbox"/> Not applicable <input type="checkbox"/> Yes <input type="checkbox"/> No	<input checked="" type="checkbox"/> Not applicable <input type="checkbox"/> Yes <input type="checkbox"/> No	<input type="checkbox"/> Not applicable <input type="checkbox"/> Yes <input type="checkbox"/> No			
Effluent Testing Data	3.10	Have you completed monitoring for all Table A parameters and attached the results to the application package? <input checked="" type="checkbox"/> Yes [Secondary effluent monitoring] <input type="checkbox"/> No						
	3.11	Have you conducted any WET tests during the 4.5 years prior to the date of the application on any of the facility's discharges or on any receiving water near the discharge points? <input type="checkbox"/> Yes <input checked="" type="checkbox"/> No → SKIP to Item 3.13.						
	3.12	Indicate the number of acute and chronic WET tests conducted since the last permit reissuance of the facility's discharges by outfall number or of the receiving water near the discharge points.						
			Outfall Number _____	Outfall Number _____	Outfall Number _____			
			Acute	Chronic	Acute	Chronic	Acute	Chronic
		Number of tests of discharge water						
		Number of tests of receiving water						
	3.13	Does the treatment works have a design flow greater than or equal to 0.1 mgd? <input checked="" type="checkbox"/> Yes <input type="checkbox"/> No → SKIP to Item 3.16.						
	3.14	Does the POTW use chlorine for disinfection, use chlorine elsewhere in the treatment process, or otherwise have reasonable potential to discharge chlorine in its effluent? <input type="checkbox"/> Yes → Complete Table B, including chlorine. <input checked="" type="checkbox"/> No → Complete Table B, omitting chlorine.						
	3.15	Have you completed monitoring for all applicable Table B pollutants and attached the results to this application package? <input checked="" type="checkbox"/> Yes [Secondary effluent monitoring] <input type="checkbox"/> No						
3.16	Does one or more of the following conditions apply? <ul style="list-style-type: none"> • The facility has a design flow greater than or equal to 1 mgd. • The POTW has an approved pretreatment program or is required to develop such a program. • The NPDES permitting authority has informed the POTW that it must sample for the parameters in Table C, must sample other additional parameters (Table D), or submit the results of WET tests for acute or chronic toxicity for each of its discharge outfalls (Table E). <input checked="" type="checkbox"/> Yes → Complete Tables C, D, and E as applicable. <input type="checkbox"/> No → SKIP to Section 4.							
3.17	Have you completed monitoring for all applicable Table C pollutants and attached the results to this application package? <input checked="" type="checkbox"/> Yes <input type="checkbox"/> No							
3.18	Have you completed monitoring for all applicable Table D pollutants required by your NPDES permitting authority and attached the results to this application package? <input checked="" type="checkbox"/> Yes <input type="checkbox"/> No additional sampling required by NPDES permitting authority.							

Effluent Testing Data Continued	3.19	Has the POTW conducted either (1) minimum of four quarterly WET tests for one year preceding this permit application or (2) at least four annual WET tests in the past 4.5 years? <input type="checkbox"/> Yes <input checked="" type="checkbox"/> No → Complete tests and Table E and SKIP to Item 3.26.				
	3.20	Have you previously submitted the results of the above tests to your NPDES permitting authority? <input type="checkbox"/> Yes <input checked="" type="checkbox"/> No → Provide results in Table E and SKIP to Item 3.26.				
	3.21	Indicate the dates the data were submitted to your NPDES permitting authority and provide a summary of the results.				
		<table border="1" style="width:100%; border-collapse: collapse;"> <tr> <th style="width:45%;">Date(s) Submitted (MM/DD/YYYY)</th> <th style="width:55%;">Summary of Results</th> </tr> <tr> <td style="height: 40px;"></td> <td>The existing secondary treatment process would not provide valid results. The required four quarterly WET tests will be performed once the treatment plant upgrades are complete.</td> </tr> </table>	Date(s) Submitted (MM/DD/YYYY)	Summary of Results		The existing secondary treatment process would not provide valid results. The required four quarterly WET tests will be performed once the treatment plant upgrades are complete.
	Date(s) Submitted (MM/DD/YYYY)	Summary of Results				
		The existing secondary treatment process would not provide valid results. The required four quarterly WET tests will be performed once the treatment plant upgrades are complete.				
	3.22	Regardless of how you provided your WET testing data to the NPDES permitting authority, did any of the tests result in toxicity? <input type="checkbox"/> Yes <input type="checkbox"/> No → SKIP to Item 3.26.				
	3.23	Describe the cause(s) of the toxicity:				
3.24	Has the treatment works conducted a toxicity reduction evaluation? <input type="checkbox"/> Yes <input type="checkbox"/> No → SKIP to Item 3.26.					
3.25	Provide details of any toxicity reduction evaluations conducted.					
3.26	Have you completed Table E for all applicable outfalls and attached the results to the application package? <input type="checkbox"/> Yes [See note below] <input checked="" type="checkbox"/> Not applicable because previously submitted information to the NPDES permitting authority.					
SECTION 4. INDUSTRIAL DISCHARGES AND HAZARDOUS WASTES (40 CFR 122.21(j)(6) and (7))						
Industrial Discharges and Hazardous Wastes	4.1	Does the POTW receive discharges from SIUs or NSCIUs? <input type="checkbox"/> Yes <input checked="" type="checkbox"/> No → SKIP to Item 4.7.				
	4.2	Indicate the number of SIUs and NSCIUs that discharge to the POTW.				
		<table border="1" style="width:100%; border-collapse: collapse;"> <tr> <th style="width:50%;">Number of SIUs</th> <th style="width:50%;">Number of NSCIUs</th> </tr> <tr> <td style="height: 20px;"></td> <td></td> </tr> </table>	Number of SIUs	Number of NSCIUs		
	Number of SIUs	Number of NSCIUs				
	4.3	Does the POTW have an approved pretreatment program? <input type="checkbox"/> Yes <input type="checkbox"/> No				
4.4	Have you submitted either of the following to the NPDES permitting authority that contains information substantially identical to that required in Table F: (1) a pretreatment program annual report submitted within one year of the application or (2) a pretreatment program? <input type="checkbox"/> Yes <input type="checkbox"/> No → SKIP to Item 4.6.					
4.5	Identify the title and date of the annual report or pretreatment program referenced in Item 4.4. SKIP to Item 4.7.					
4.6	Have you completed and attached Table F to this application package? <input type="checkbox"/> Yes <input type="checkbox"/> No					

Note: The treatment process will be upgraded prior to commencement of discharge. Toxicity testing will be performed at that time.

Industrial Discharges and Hazardous Wastes Continued	4.7	Does the POTW receive, or has it been notified that it will receive, by truck, rail, or dedicated pipe, any wastes that are regulated as RCRA hazardous wastes pursuant to 40 CFR 261? <input type="checkbox"/> Yes <input checked="" type="checkbox"/> No → SKIP to Item 4.9.			
	4.8	If yes, provide the following information:			
		Hazardous Waste Number	Waste Transport Method (check all that apply)		Annual Amount of Waste Received
			<input type="checkbox"/> Truck <input type="checkbox"/> Dedicated pipe	<input type="checkbox"/> Rail <input type="checkbox"/> Other (specify) _____	
			<input type="checkbox"/> Truck <input type="checkbox"/> Dedicated pipe	<input type="checkbox"/> Rail <input type="checkbox"/> Other (specify) _____	
			<input type="checkbox"/> Truck <input type="checkbox"/> Dedicated pipe	<input type="checkbox"/> Rail <input type="checkbox"/> Other (specify) _____	
	4.9	Does the POTW receive, or has it been notified that it will receive, wastewaters that originate from remedial activities, including those undertaken pursuant to CERCLA and Sections 3004(7) or 3008(h) of RCRA? <input type="checkbox"/> Yes <input checked="" type="checkbox"/> No → SKIP to Section 5.			
	4.10	Does the POTW receive (or expect to receive) less than 15 kilograms per month of non-acute hazardous wastes as specified in 40 CFR 261.30(d) and 261.33(e)? <input type="checkbox"/> Yes → SKIP to Section 5. <input type="checkbox"/> No			
	4.11	Have you reported the following information in an attachment to this application: identification and description of the site(s) or facility(ies) at which the wastewater originates; the identities of the wastewater's hazardous constituents; and the extent of treatment, if any, the wastewater receives or will receive before entering the POTW? <input type="checkbox"/> Yes <input type="checkbox"/> No			

SECTION 5. COMBINED SEWER OVERFLOWS (40 CFR 122.21(j)(8))

CSO Map and Diagram	5.1	Does the treatment works have a combined sewer system? <input type="checkbox"/> Yes <input checked="" type="checkbox"/> No → SKIP to Section 6.			
	5.2	Have you attached a CSO system map to this application? (See instructions for map requirements.) <input type="checkbox"/> Yes <input type="checkbox"/> No			
	5.3	Have you attached a CSO system diagram to this application? (See instructions for diagram requirements.) <input type="checkbox"/> Yes <input type="checkbox"/> No			

EPA Identification Number	NPDES Permit Number CA8000344	Facility Name Big Bear City RTP
---------------------------	----------------------------------	------------------------------------

Form Approved 03/05/19
OMB No. 2040-0004

CSO Outfall Description	5.4	For each CSO outfall, provide the following information. (Attach additional sheets as necessary.)		
		CSO Outfall Number ____	CSO Outfall Number ____	CSO Outfall Number ____
	City or town			
	State and ZIP code			
	County			
	Latitude	° ' "	° ' "	° ' "
	Longitude	° ' "	° ' "	° ' "
	Distance from shore	ft.	ft.	ft.
Depth below surface	ft.	ft.	ft.	
CSO Monitoring	5.5	Did the POTW monitor any of the following items in the past year for its CSO outfalls?		
		CSO Outfall Number ____	CSO Outfall Number ____	CSO Outfall Number ____
	Rainfall	<input type="checkbox"/> Yes <input type="checkbox"/> No	<input type="checkbox"/> Yes <input type="checkbox"/> No	<input type="checkbox"/> Yes <input type="checkbox"/> No
	CSO flow volume	<input type="checkbox"/> Yes <input type="checkbox"/> No	<input type="checkbox"/> Yes <input type="checkbox"/> No	<input type="checkbox"/> Yes <input type="checkbox"/> No
	CSO pollutant concentrations	<input type="checkbox"/> Yes <input type="checkbox"/> No	<input type="checkbox"/> Yes <input type="checkbox"/> No	<input type="checkbox"/> Yes <input type="checkbox"/> No
	Receiving water quality	<input type="checkbox"/> Yes <input type="checkbox"/> No	<input type="checkbox"/> Yes <input type="checkbox"/> No	<input type="checkbox"/> Yes <input type="checkbox"/> No
	CSO frequency	<input type="checkbox"/> Yes <input type="checkbox"/> No	<input type="checkbox"/> Yes <input type="checkbox"/> No	<input type="checkbox"/> Yes <input type="checkbox"/> No
Number of storm events	<input type="checkbox"/> Yes <input type="checkbox"/> No	<input type="checkbox"/> Yes <input type="checkbox"/> No	<input type="checkbox"/> Yes <input type="checkbox"/> No	
CSO Events in Past Year	5.6	Provide the following information for each of your CSO outfalls.		
		CSO Outfall Number ____	CSO Outfall Number ____	CSO Outfall Number ____
	Number of CSO events in the past year	events	events	events
	Average duration per event	hours <input type="checkbox"/> Actual or <input type="checkbox"/> Estimated	hours <input type="checkbox"/> Actual or <input type="checkbox"/> Estimated	hours <input type="checkbox"/> Actual or <input type="checkbox"/> Estimated
	Average volume per event	million gallons <input type="checkbox"/> Actual or <input type="checkbox"/> Estimated	million gallons <input type="checkbox"/> Actual or <input type="checkbox"/> Estimated	million gallons <input type="checkbox"/> Actual or <input type="checkbox"/> Estimated
	Minimum rainfall causing a CSO event in last year	inches of rainfall <input type="checkbox"/> Actual or <input type="checkbox"/> Estimated	inches of rainfall <input type="checkbox"/> Actual or <input type="checkbox"/> Estimated	inches of rainfall <input type="checkbox"/> Actual or <input type="checkbox"/> Estimated

EPA Identification Number

NPDES Permit Number

Facility Name

Form Approved 03/05/19

OMB No. 2040-0004

CA8000344

Big Bear City RTP

CSO Receiving Waters

5.7

Provide the information in the table below for each of your CSO outfalls.

	CSO Outfall Number ____	CSO Outfall Number ____	CSO Outfall Number ____
Receiving water name			
Name of watershed/ stream system			
U.S. Soil Conservation Service 14-digit watershed code (if known)	<input type="checkbox"/> Unknown	<input type="checkbox"/> Unknown	<input type="checkbox"/> Unknown
Name of state management/river basin			
U.S. Geological Survey 8-Digit Hydrologic Unit Code (if known)	<input type="checkbox"/> Unknown	<input type="checkbox"/> Unknown	<input type="checkbox"/> Unknown
Description of known water quality impacts on receiving stream by CSO (see instructions for examples)			

SECTION 6. CHECKLIST AND CERTIFICATION STATEMENT (40 CFR 122.22(a) and (d))

Checklist and Certification Statement

6.1

In Column 1 below, mark the sections of Form 2A that you have completed and are submitting with your application. For each section, specify in Column 2 any attachments that you are enclosing to alert the permitting authority. Note that not all applicants are required to provide attachments.

Column 1	Column 2
<input checked="" type="checkbox"/> Section 1: Basic Application Information for All Applicants	<input type="checkbox"/> w/ variance request(s) <input type="checkbox"/> w/ additional attachments
<input checked="" type="checkbox"/> Section 2: Additional Information	<input checked="" type="checkbox"/> w/ topographic map <input checked="" type="checkbox"/> w/ additional attachments
<input checked="" type="checkbox"/> Section 3: Information on Effluent Discharges	<input checked="" type="checkbox"/> w/ Table A <input checked="" type="checkbox"/> w/ Table B <input checked="" type="checkbox"/> w/ Table C <input type="checkbox"/> w/ Table E <input type="checkbox"/> w/ additional attachments
<input type="checkbox"/> Section 4: Industrial Discharges and Hazardous Wastes	<input type="checkbox"/> w/ SIU and NSCIU attachments <input type="checkbox"/> w/ additional attachments <input type="checkbox"/> w/ Table F
<input type="checkbox"/> Section 5: Combined Sewer Overflows	<input type="checkbox"/> w/ CSO map <input type="checkbox"/> w/ CSO system diagram <input type="checkbox"/> w/ additional attachments
<input checked="" type="checkbox"/> Section 6: Checklist and Certification Statement	<input type="checkbox"/> w/ attachments

6.2

Certification Statement

I certify under penalty of law that this document and all attachments were prepared under my direction or supervision in accordance with a system designed to assure that qualified personnel properly gather and evaluate the information submitted. Based on my inquiry of the person or persons who manage the system, or those persons directly responsible for gathering the information, the information submitted is, to the best of my knowledge and belief, true, accurate, and complete. I am aware that there are significant penalties for submitting false information, including the possibility of fine and imprisonment for knowing violations.

Name (print or type first and last name)

David Lawrence

Official title

General Manager

Signature



Date signed

2/28/2022

EPA Identification Number	NPDES Permit Number CA8000344	Facility Name Big Bear City RTP	Outfall Number Current secondary
---------------------------	----------------------------------	------------------------------------	-------------------------------------

Form Approved 03/05/19
OMB No. 2040-0004

TABLE A. EFFLUENT PARAMETERS FOR ALL POTWS

Pollutant	Maximum Daily Discharge		Average Daily Discharge			Analytical Method ¹	ML or MDL (include units)
	Value	Units	Value	Units	Number of Samples		
Biochemical oxygen demand <input checked="" type="checkbox"/> BOD ₅ or <input type="checkbox"/> CBOD ₅ (report one)	36	mg/L	8.5	mg/L	301	SM 5210B	2 <input checked="" type="checkbox"/> ML <input type="checkbox"/> MDL
Fecal coliform	24,000	MPN/100mL	ND	MPN/100mL	2	SM 9221	1800 <input checked="" type="checkbox"/> ML <input type="checkbox"/> MDL
Flow rate	8.4	MGD	2.0	MGD	2131		
pH (minimum)	6.9	SU					
pH (maximum)	8.5	SU					
Temperature (winter)	16.0	C	12.2	C	181		
Temperature (summer)	21.5	C	18.1	C	184		
Total suspended solids (TSS)	44	mg/L	7.7	mg/L	298	SM 2540D	5 <input checked="" type="checkbox"/> ML <input type="checkbox"/> MDL

¹ Sampling shall be conducted according to sufficiently sensitive test procedures (i.e., methods) approved under 40 CFR 136 for the analysis of pollutants or pollutant parameters or required under 40 CFR chapter I, subchapter N or O. See instructions and 40 CFR 122.21(e)(3).

Note: Samples were collected from the currently existing facility which produces undisinfected secondary effluent, currently sent to land application under the WDRs. Future effluent discharged to surface water will be treated to tertiary levels followed by 100% reverse osmosis and UV disinfection after treatment plant upgrades.

EPA Identification Number	NPDES Permit Number CA8000344	Facility Name Big Bear City RTP	Outfall Number Current secondary
---------------------------	----------------------------------	------------------------------------	-------------------------------------

Form Approved 03/05/19
OMB No. 2040-0004

TABLE B. EFFLUENT PARAMETERS FOR ALL POTWS WITH A FLOW EQUAL TO OR GREATER THAN 0.1 MGD

Pollutant	Maximum Daily Discharge		Average Daily Discharge			Analytical Method ¹	ML or MDL (include units)
	Value	Units	Value	Units	Number of Samples		
Ammonia (as N)	22	mg/L	3.2	mg/L	24 (from 2019)	EPA 350.1	0.6 <input checked="" type="checkbox"/> ML <input type="checkbox"/> MDL
Chlorine (total residual, TRC) ²					0		<input type="checkbox"/> ML <input type="checkbox"/> MDL
Dissolved oxygen	7.3	mg/L	4.8	mg/L	12		<input type="checkbox"/> ML <input type="checkbox"/> MDL
Nitrate/nitrite	9.3	mg/L	1.9	mg/L	25 [from 2019]	EPA 300.0	0.4 <input checked="" type="checkbox"/> ML <input type="checkbox"/> MDL
Kjeldahl nitrogen	23	mg/L	4.4	mg/L	24 (from 2019)	EPA 351.2	1 <input checked="" type="checkbox"/> ML <input type="checkbox"/> MDL
Oil and grease	4.1	mg/L	-	mg/L	1	EPA 1664B	2.1 <input type="checkbox"/> ML <input checked="" type="checkbox"/> MDL
Phosphorus	14.7	mg/L	2.1	mg/L	83	SM 4500 PE	0.013 <input checked="" type="checkbox"/> ML <input type="checkbox"/> MDL
Total dissolved solids	520	mg/L	442	mg/L	70	SM 2540C	5 <input checked="" type="checkbox"/> ML <input type="checkbox"/> MDL

¹ Sampling shall be conducted according to sufficiently sensitive test procedures (i.e., methods) approved under 40 CFR 136 for the analysis of pollutants or pollutant parameters or required under 40 CFR chapter I, subchapter N or O. See instructions and 40 CFR 122.21(e)(3).

² Facilities that do not use chlorine for disinfection, do not use chlorine elsewhere in the treatment process, and have no reasonable potential to discharge chlorine in their effluent are not required to report data for chlorine.

Note: Samples were collected from the currently existing facility which produces undisinfected secondary effluent, currently sent to land application under the WDRs. Future effluent discharged to surface water will be treated to tertiary levels followed by 100% reverse osmosis and UV disinfection after treatment plant upgrades.

Big Bear City Regional Treatment Plant
Form 2A Table C, Secondary Effluent

Pollutant	Maximum Daily Discharge		Average Daily Discharge		Number of samples	Analytical Method	MDL	RL
	Value	Units	Value	Units				
Metals, Cyanide, and Dioxin								
Antimony, Total	0.23	µg/L	ID	µg/L	8	EPA 200.8	0.14	6
Arsenic, Total	0.73	µg/L	ID	µg/L	8	EPA 200.8	0.4	2
Beryllium, Total	ND	µg/L	ND	µg/L	8	EPA 200.8	0.2	1
Cadmium, Total	ND	µg/L	ND	µg/L	8	EPA 200.8	0.11	1
Chromium (III)	2.6	µg/L	ID	µg/L	6	Calculated		
Chromium (VI)	ND	µg/L	ND	µg/L	8	EPA 218.6	0.14	1
Chromium (total)	0.89	µg/L	ID	µg/L	2	EPA 200.8	0.21	10
Copper, Total	J 14	µg/L	ID	µg/L	8	EPA 200.7	6.5	50
Lead, Total	J 1.8	µg/L	ID	µg/L	8	EPA 200.8	0.51	5
Mercury, Total	0.00076	µg/L	ND	µg/L	8	EPA 245.1/ EPA 1631E	0.15	0.0005-0.2
Nickel, Total	6.3	µg/L	ID	µg/L	8	EPA 200.8	0.52	10
Selenium, Total	J 2.7	µg/L	ID	µg/L	8	EPA 200.8	0.95	5
Silver, Total	0.3	µg/L	ID	µg/L	8	EPA 200.8	0.3	10
Thallium, Total	ND	µg/L	ND	µg/L	8	EPA 200.8	0.18	1
Zinc, Total	120.0	µg/L	80.2	µg/L	8	EPA 200.7	15	50
Cyanide, Total (as CN)	2.7	µg/L	2.4	µg/L	2	SM4500-CN E	1.2	5
Asbestos	2.0	MFL	2.0	MFL	1	EPA 100.2	0.5	50
TCDD Equivalence (TEQ)	ND	pg/L	ND	pg/L	1	EPA 1613B	5	
Volatile Organic Compounds								
Acrolein	ND	µg/L	ND	µg/L	6	EPA 624.1	1.2	2
Acrylonitrile	ND	µg/L	ND	µg/L	6	EPA 624.1	0.6	2
Benzene	ND	µg/L	ND	µg/L	6	EPA 624.1	0.096	0.5
Bromoform	ND	µg/L	ND	µg/L	6	EPA 624.1	0.072	0.5
Carbon Tetrachloride	ND	µg/L	ND	µg/L	6	EPA 624.1	0.1	0.5
Chlorobenzene	ND	µg/L	ND	µg/L	6	EPA 624.1	0.088	0.5
Dibromochloromethane	ND	µg/L	ND	µg/L	6	EPA 624.1	0.052	0.5
Chloroethane	ND	µg/L	ND	µg/L	6	EPA 624.1	0.18	0.5
2-Chloroethylvinyl Ether	ND	µg/L	ND	µg/L	6	EPA 624.1	0.72	1
Chloroform	ND	µg/L	ND	µg/L	6	EPA 624.1	0.079	0.5
Bromodichloromethane	ND	µg/L	ND	µg/L	6	EPA 624.1	0.058	0.5
1,1-Dichloroethane	ND	µg/L	ND	µg/L	6	EPA 624.1	0.08	0.5
1,2-Dichloroethane	ND	µg/L	ND	µg/L	6	EPA 624.1	0.06	0.5

Big Bear City Regional Treatment Plant
Form 2A Table C, Secondary Effluent

Pollutant	Maximum Daily Discharge		Average Daily Discharge		Number of samples	Analytical Method	MDL	RL
	Value	Units	Value	Units				
1,1-Dichloroethylene	ND	µg/L	ND	µg/L	6	EPA 624.1	0.12	0.5
1,2-Dichloropropane	ND	µg/L	ND	µg/L	6	EPA 624.1	0.066	0.5
1,3-Dichloropropylene	ND	µg/L	ND	µg/L	6	EPA 624.1	0.11	0.5
Ethylbenzene	ND	µg/L	ND	µg/L	6	EPA 624.1	0.098	2
Bromomethane	ND	µg/L	ND	µg/L	6	EPA 624.1	0.19	0.5
Chloromethane	ND	µg/L	ND	µg/L	6	EPA 624.1	0.19	2
Methylene Chloride	ND	µg/L	ND	µg/L	6	EPA 624.1	0.076	2
1,1,2,2-Tetrachloroethane	ND	µg/L	ND	µg/L	6	EPA 624.1	0.11	0.5
Tetrachloroethene	ND	µg/L	ND	µg/L	6	EPA 624.1	0.11	0.5
Toluene	ND	µg/L	ND	µg/L	6	EPA 624.1	0.07	2
trans-1,2-Dichloroethene	ND	µg/L	ND	µg/L	6	EPA 624.1	0.11	1
1,1,1-Trichloroethane	ND	µg/L	ND	µg/L	6	EPA 624.1	0.06	0.5
1,1,2-Trichloroethane	ND	µg/L	ND	µg/L	6	EPA 624.1	0.068	0.5
Trichloroethene	ND	µg/L	ND	µg/L	6	EPA 624.1	0.082	2
Vinyl Chloride	ND	µg/L	ND	µg/L	6	EPA 624.1	0.12	0.5
Acid-Extractable Compounds								
2-Chlorophenol	ND	µg/L	ND	µg/L	6	EPA 625	2.7	10
2,4-Dichlorophenol	ND	µg/L	ND	µg/L	6	EPA 625	3.5	5
2,4-Dimethylphenol	ND	µg/L	ND	µg/L	6	EPA 625	3	10
4,6-Dinitro-2-methylphenol	ND	µg/L	ND	µg/L	6	EPA 625	3.7	50
2,4-Dinitrophenol	ND	µg/L	ND	µg/L	6	EPA 625	2.6	25
2-Nitrophenol	ND	µg/L	ND	µg/L	6	EPA 625	2.5	50
4-Nitrophenol	ND	µg/L	ND	µg/L	6	EPA 625	2.8	50
4-Chloro-3-methylphenol	ND	µg/L	ND	µg/L	6	EPA 625	3.4	25
Pentachlorophenol	ND	µg/L	ND	µg/L	6	EPA 625	4.9	25
Phenol, Single Compound	ND	µg/L	ND	µg/L	6	EPA 625	2.5	5
2,4,6-Trichlorophenol	ND	µg/L	ND	µg/L	6	EPA 625	3.6	50
Base-Neutral Compounds								
Acenaphthene	ND	µg/L	ND	µg/L	1	EPA 610	0.27	0.5
Acenaphthylene	ND	µg/L	ND	µg/L	1	EPA 610	0.011	0.2
Anthracene	ND	µg/L	ND	µg/L	1	EPA 610	0.029	0.2
Benidine	ND	µg/L	ND	µg/L	1	EPA 625	2.5	25
Benzo(a)anthracene	ND	µg/L	ND	µg/L	1	EPA 610	0.023	0.2

Big Bear City Regional Treatment Plant
Form 2A Table C, Secondary Effluent

Pollutant	Maximum Daily Discharge		Average Daily Discharge		Number of samples	Analytical Method	MDL	RL
	Value	Units	Value	Units				
Benzo(a)pyrene	ND	µg/L	ND	µg/L	1	EPA 610	0.03	0.1
Benzo(b)fluoranthene	ND	µg/L	ND	µg/L	1	EPA 610	0.03	0.5
Benzo(ghi)perylene	ND	µg/L	ND	µg/L	1	EPA 610	0.029	0.2
Benzo(k)fluoranthene	ND	µg/L	ND	µg/L	1	EPA 610	0.029	0.2
Bis (2-Chloroethoxy) Methane	ND	µg/L	ND	µg/L	1	EPA 625	2.8	25
Bis (2-Chloroethyl) Ether	ND	µg/L	ND	µg/L	1	EPA 625	2.5	5
Bis (2-Chloroisopropyl) Ether	ND	µg/L	ND	µg/L	1	EPA 625	2.5	50
Bis (2-Ethylhexyl) Phthalate	ND	µg/L	ND	µg/L	1	EPA 625	3.3	7.5
4-Bromophenyl Phenyl Ether	ND	µg/L	ND	µg/L	1	EPA 625	2.5	50
Butylbenzyl Phthalate	ND	µg/L	ND	µg/L	1	EPA 625	6	50
2-Chloronaphthalene	ND	µg/L	ND	µg/L	1	EPA 625	2.5	50
4-Chlorophenyl Phenyl Ether	ND	µg/L	ND	µg/L	1	EPA 625	2.5	25
Chrysene	ND	µg/L	ND	µg/L	1	EPA 610	0.028	0.2
Dibenzo(a,h)anthracene	ND	µg/L	ND	µg/L	1	EPA 610	0.027	0.1
1,2-Dichlorobenzene	ND	µg/L	ND	µg/L	1	EPA 624.1	0.059	0.5
1,3-Dichlorobenzene	ND	µg/L	ND	µg/L	1	EPA 624.1	0.077	2
1,4-Dichlorobenzene	ND	µg/L	ND	µg/L	1	EPA 624.1	0.26	0.5
3,3-Dichlorobenzidine	ND	µg/L	ND	µg/L	1	EPA 625	2.5	25
Diethyl Phthalate	ND	µg/L	ND	µg/L	1	EPA 625	2.7	10
Dimethyl Phthalate	ND	µg/L	ND	µg/L	1	EPA 625	5.5	10
Di-n-butyl Phthalate	ND	µg/L	ND	µg/L	1	EPA 625	3.7	50
2,4-Dinitrotoluene	ND	µg/L	ND	µg/L	1	EPA 625	3	25
2,6-Dinitrotoluene	ND	µg/L	ND	µg/L	1	EPA 625	3.9	25
Di-n-octyl Phthalate	ND	µg/L	ND	µg/L	1	EPA 625	3.6	50
1,2-Diphenylhydrazine	ND	µg/L	ND	µg/L	1	EPA 625	2.5	5
Fluoranthene	ND	µg/L	ND	µg/L	1	EPA 610	0.033	0.2
Fluorene	ND	µg/L	ND	µg/L	1	EPA 610	0.15	0.2
Hexachlorobenzene	ND	µg/L	ND	µg/L	1	EPA 625	2.5	5
Hexachlorobutadiene	ND	µg/L	ND	µg/L	1	EPA 624.1	0.13	1
Hexachlorocyclopentadiene	ND	µg/L	ND	µg/L	1	EPA 625	2.5	25
Hexachloroethane	ND	µg/L	ND	µg/L	1	EPA 625	2.5	5
Indeno (1,2,3-cd) Pyrene	ND	µg/L	ND	µg/L	1	EPA 610	0.035	0.05
Isophorone	ND	µg/L	ND	µg/L	1	EPA 625	2.8	5

Big Bear City Regional Treatment Plant
Form 2A Table C, Secondary Effluent

Pollutant	Maximum Daily Discharge		Average Daily Discharge		Number of samples	Analytical Method	MDL	RL
	Value	Units	Value	Units				
Naphthalene	ND	µg/L	ND	µg/L	1	EPA 625	0.018	0.2
Nitrobenzene	ND	µg/L	ND	µg/L	1	EPA 625	2.6	50
N-Nitrosodimethylamine	ND	µg/L	ND	µg/L	1	EPA 625	2.5	25
N-Nitrosodi-n-Propylamine	ND	µg/L	ND	µg/L	1	EPA 625	2.5	25
N-Nitrosodiphenylamine	ND	µg/L	ND	µg/L	1	EPA 625	3.6	5
Phenanthrene	ND	µg/L	ND	µg/L	1	EPA 610	0.012	0.2
Pyrene	ND	µg/L	ND	µg/L	1	EPA 610	0.04	0.2
1,2,4-Trichlorobenzene	ND	µg/L	ND	µg/L	1	EPA 624.1	0.79	5

Notes:
The secondary effluent dataset extends from June 2017 through November 2021.
Discharge to surface water will not commence until treatment plant upgrades are complete (estimated July 2026). Therefore, these data are not representative of future tertiary quality.
ND = All data were undetected below the MDL.
J = The result is estimated above the MDL and below the RL.
ID = There were insufficient detected data for calculating an average.

Big Bear City Regional Treatment Plant
Form 2A Table D Additional, Secondary Effluent

Pollutant	Maximum Daily Discharge		Average Daily Discharge		Number of samples	Analytical Method	MDL	RL
	Value	Units	Value	Units				
Aldrin	ND	µg/L	ND	µg/L	1	EPA 608	0.0078	0.025
alpha-BHC	ND	µg/L	ND	µg/L	1	EPA 608	0.0082	0.05
beta-BHC	ND	µg/L	ND	µg/L	1	EPA 608	0.0088	0.025
gamma-BHC	ND	µg/L	ND	µg/L	1	EPA 608	0.0072	0.1
delta-BHC	ND	µg/L	ND	µg/L	1	EPA 608	0.0068	0.025
Chlordane	ND	µg/L	ND	µg/L	1	EPA 608	0.17	0.5
4,4-DDT	ND	µg/L	ND	µg/L	1	EPA 608	0.0052	0.05
4,4-DDE	ND	µg/L	ND	µg/L	1	EPA 608	0.01	0.25
4,4-DDD	ND	µg/L	ND	µg/L	1	EPA 608	0.05	0.25
Dieldrin	ND	µg/L	ND	µg/L	1	EPA 608	0.0092	0.05
Endosulfan I	ND	µg/L	ND	µg/L	1	EPA 608	0.0084	0.1
Endosulfan II	ND	µg/L	ND	µg/L	1	EPA 608	0.0046	0.05
Endosulfan Sulfate	ND	µg/L	ND	µg/L	1	EPA 608	0.012	0.25
Endrin	ND	µg/L	ND	µg/L	1	EPA 608	0.0096	0.05
Endrin Aldehyde	ND	µg/L	ND	µg/L	1	EPA 608	0.01	0.05
Heptachlor	ND	µg/L	ND	µg/L	1	EPA 608	0.0088	0.05
Heptachlor Epoxide	ND	µg/L	ND	µg/L	1	EPA 608	0.0076	0.05
PCB-1016	ND	µg/L	ND	µg/L	1	EPA 608	2.5	2.5
PCB-1221	ND	µg/L	ND	µg/L	1	EPA 608	2.5	2.5
PCB-1232	ND	µg/L	ND	µg/L	1	EPA 608	2.5	2.5
PCB-1242	ND	µg/L	ND	µg/L	1	EPA 608	2.5	2.5
PCB-1248	ND	µg/L	ND	µg/L	1	EPA 608	2.5	2.5
PCB-1254	ND	µg/L	ND	µg/L	1	EPA 608	2.5	2.5
PCB-1260	ND	µg/L	ND	µg/L	1	EPA 608	2.5	2.5
Toxaphene	ND	µg/L	ND	µg/L	1	EPA 608	0.26	2.5
Aluminum (Al)	250	µg/L	180	µg/L	2	EPA 200.7	14	50
Barium (Ba)	46	µg/L	46	µg/L	1	EPA 200.7	12	100
Iron (Fe)	150	µg/L	150	µg/L	1	EPA 200.7	14	100
Iron (Fe) Dissolved	J 22	µg/L	22	µg/L	1	EPA 200.7	14	100
Manganese (Mn)	21	µg/L	21	µg/L	1	EPA 200.7	0.8	20
Manganese (Mn) Dissolved	ND	µg/L	ND	µg/L	1	EPA 200.7	0.8	20
Chloride	87	mg/L	56	mg/L	144	EPA 300.0		1
Fluoride (F)	0.52	mg/L	0.41	mg/L	2	EPA 300.0	0.026	0.1
Nitrate as N	1.3	mg/L	0.89	mg/L	2	EPA 300.0	0.12	0.4

Big Bear City Regional Treatment Plant
Form 2A Table D Additional, Secondary Effluent

Pollutant	Maximum Daily Discharge		Average Daily Discharge		Number of samples	Analytical Method	MDL	RL
	Value	Units	Value	Units				
NO2+NO3 as N	9.3	mg/L	1.9	mg/L	25	Calculation		0.4
Nitrite as N	ND	mg/L	ND	mg/L	1	EPA 300.0	0.17	0.4
Sulfate	48	mg/L	40	mg/L	131	EPA 300.0		0.5
MBAS	0.14	mg/L	0.14	mg/L	2	SM 5540C	0.047	0.1
Methyl tert-Butyl Ether	ND	µg/L	ND	µg/L	1	EPA 624	0.069	3
Styrene	ND	µg/L	ND	µg/L	1	EPA 624	0.059	0.5
Xylenes	ND	µg/L	ND	µg/L	1	EPA 624	0.26	0.5
Total Trihalomethanes (TTHM)	ND	µg/L	ND	µg/L	1	EPA 624	0.22	0.5
Sodium (Na)	89	mg/L	60	mg/L	24	EPA 200.7		1
Boron (B)	270	µg/L	265	µg/L	2	EPA 200.7	32	100

Notes:
The secondary effluent dataset extends from June 2017 through November 2021.
Discharge to surface water will not commence until treatment plant upgrades are complete (estimated July 2026). Therefore, these data are not representative of future tertiary quality.
ND = All data were undetected below the MDL.
J = The result is estimated above the MDL and below the RL.

III. NPDES Form 2S - Biosolids

Part 2, Section 1 – General Information

Part 2, Section 2 – Generation of Sewage Sludge

Part 2, Section 3 – Land Application (not applicable)

Part 2, Section 4 – Surface Disposal (not applicable)

Part 2, Section 5 – Incineration (not applicable)

PART 2	PERMIT APPLICATION INFORMATION (40 CFR 122.21(q))
---------------	----------------------------------------------------------

Complete this part if you have an effective NPDES permit or have been directed by the NPDES permitting authority to submit a full permit application. In other words, complete this part if your facility has, or is applying for, an NPDES permit. Part 2 is divided into five sections. Section 1 pertains to all applicants. The applicability of Sections 2 to 5 depends on your facility's sewage sludge use or disposal practices. See the instructions to determine which sections you are required to complete.

PART 2, SECTION 1. GENERAL INFORMATION (40 CFR 122.21(q)(1-7) AND (q)(13))

General Information	All Part 2 applicants must complete this section.				
	Facility Information				
	1.1	Facility name Regional Treatment Plant, Big Bear City			
		Mailing address (street or P.O. box) 121 Palomino Drive, P.O. Box 517			
		City or town Big Bear City	State CA	ZIP code 92314	Phone number (909) 584-4520
		Contact name (first and last) John Shimmin	Title Plant Manager	Email address JShimmin@BBARWA.org	
		Location address (street, route number, or other specific identifier) 122 Palomino Drive			<input type="checkbox"/> Same as mailing address
		City or town Big Bear City	State CA	ZIP code 92314	
	1.2	Is this facility a Class I sludge management facility? <input type="checkbox"/> Yes <input checked="" type="checkbox"/> No			
	1.3	Facility Design Flow Rate	4.89 million gallons per day (mgd)		
	1.4	Total Population Served	19,354		
	1.5	Ownership Status			
		<input type="checkbox"/> Public—federal <input type="checkbox"/> Public—state <input checked="" type="checkbox"/> Other public (specify) <u>Municipal</u> <input type="checkbox"/> Private <input type="checkbox"/> Other (specify) _____			
	Applicant Information				
	1.6	Is applicant different from entity listed under Item 1.1 above? <input checked="" type="checkbox"/> Yes <input type="checkbox"/> No → SKIP to Item 1.8 (Part 2, Section 1).			
1.7	Applicant name Big Bear Area Regional Wastewater Agency				
	Applicant mailing address (street or P.O. box) 121 Palomino Drive, P.O. Box 517				
	City or town Big Bear City	State CA	ZIP code 92314		
	Contact name (first and last) David Lawrence	Title General Manager	Phone number (909) 584-4521	Email address dlawrence@bbarwa.org	
1.8	Is the applicant the facility's owner, operator, or both? (Check only one response.) <input type="checkbox"/> Operator <input type="checkbox"/> Owner <input checked="" type="checkbox"/> Both				
1.9	To which entity should the NPDES permitting authority send correspondence? (Check only one response.) <input type="checkbox"/> Facility <input checked="" type="checkbox"/> Applicant <input type="checkbox"/> Facility and applicant (they are one and the same)				

EPA Identification Number		NPDES Permit Number CA8000344	Facility Name Big Bear City RTP	Form Approved 03/05/19 OMB No. 2040-0004
1.10	Facility's NPDES permit number <input type="checkbox"/> Check here if you do not have an NPDES permit but are otherwise required to submit Part 2 of Form 2S.			See Note below CA8000344
1.11	Indicate all other federal, state, and local permits or construction approvals received or applied for that regulate this facility's sewage sludge management practices below.			
	<input type="checkbox"/> RCRA (hazardous wastes)	<input type="checkbox"/> Nonattainment program (CAA)	<input type="checkbox"/> NESHAPs (CAA)	
	<input type="checkbox"/> PSD (air emissions)	<input type="checkbox"/> Dredge or fill (CWA Section 404)	<input type="checkbox"/> Other (specify)	
	<input type="checkbox"/> Ocean dumping (MPRSA)	<input type="checkbox"/> UIC (underground injection of fluids)		
Indian Country				
1.12	Does any generation, treatment, storage, application to land, or disposal of sewage sludge from this facility occur in Indian Country? <input type="checkbox"/> Yes <input checked="" type="checkbox"/> No → SKIP to Item 1.14 (Part 2, Section 1) below.			
1.13	Provide a description of the generation, treatment, storage, land application, or disposal of sewage sludge that occurs.			
Topographic Map				
1.14	Have you attached a topographic map containing all required information to this application? (See instructions for specific requirements.) <input checked="" type="checkbox"/> Yes <input type="checkbox"/> No			
Line Drawing				
1.15	Have you attached a line drawing and/or a narrative description that identifies all sewage sludge practices that will be employed during the term of the permit containing all the required information to this application? (See instructions for specific requirements.) <input checked="" type="checkbox"/> Yes <input type="checkbox"/> No			
Contractor Information				
1.16	Do contractors have any operational or maintenance responsibilities related to sewage sludge generation, treatment, use, or disposal at the facility? <input checked="" type="checkbox"/> Yes <input type="checkbox"/> No → SKIP to Item 1.18 (Part 2, Section 1) below.			
1.17	Provide the following information for each contractor. <input type="checkbox"/> Check here if you have attached additional sheets to the application package.			
		Contractor 1	Contractor 2	Contractor 3
	Contractor company name	Ag Tech LLC	Synagro West, LLC	
	Mailing address (street or P.O. box)	3895 W. County 19th St	14479 Cougar Road	
	City, state, and ZIP code	Somerton, AZ 85350	Helendale, CA 92342	
	Contact name (first and last)	Cal Mullenix	Jamie Little	
	Telephone number	(602) 377-7250	(661) 765-2200	
	Email address	cal@westexp.com	jlittle@synagro.com	

Note: This NPDES permit for discharge to surface water expired February 1, 2005.

EPA Identification Number

NPDES Permit Number

Facility Name

Form Approved 03/05/19

OMB No. 2040-0004

CA8000344

Big Bear City RTP

1.17

cont.

Contractor 1**Contractor 2****Contractor 3**

Responsibilities of contractor

Sludge hauling through
August 2021.Sludge hauling beginning
September 2021.**Pollutant Concentrations**

Using the table below or a separate attachment, provide sewage sludge monitoring data for the pollutants for which limits in sewage sludge have been established in 40 CFR 503 for this facility's expected use or disposal practices. All data must be based on three or more samples taken at least one month apart and must be no more than 4.5 years old.

[Based on 15 samples collected between 2018-2021.]

 Check here if you have attached additional sheets to the application package.

1.18

Pollutant**Average Monthly
Concentration**
(mg/kg dry weight)**Analytical Method****Detection Level**

Arsenic

ND

EPA 6010

10

Cadmium

ND

EPA 6010

5

Chromium

8.4

EPA 6010

14

Copper

239

EPA 6010

-

Lead

12.2

EPA 6010

17

Mercury

0.55

EPA 7471

0.66

Molybdenum

4.9

EPA 6010

8

Nickel

8.7

EPA 6010

8

Selenium

ND

EPA 6010

1-30

Zinc

524

EPA 6010

-

Checklist and Certification Statement

1.19

In Column 1 below, mark the sections of Form 2S, Part 2, that you have completed and are submitting with your application. For each section, specify in Column 2 any attachments that you are enclosing. Note that not all applicants are required to complete all sections or provide attachments. See Exhibit 2S-2 in the Instructions.

Column 1**Column 2**

Section 1 (General Information)



w/ attachments

Section 2 (Generation of Sewage Sludge or Preparation of a Material
Derived from Sewage Sludge)

w/ attachments



Section 3 (Land Application of Bulk Sewage Sludge)



w/ attachments



Section 4 (Surface Disposal)



w/ attachments



Section 5 (Incineration)



w/ attachments

1.20

Certification Statement

I certify under penalty of law that this document and all attachments were prepared under my direction or supervision in accordance with a system designed to assure that qualified personnel properly gather and evaluate the information submitted. Based on my inquiry of the person or persons who manage the system, or those persons directly responsible for gathering the information, the information submitted is, to the best of my knowledge and belief, true, accurate, and complete. I am aware that there are significant penalties for submitting false information, including the possibility of fine and imprisonment for knowing violations.

Name (print or type first and last name)

David Lawrence

Official title

General Manager

Signature

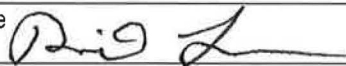

Date signed

2/28/2022

Telephone number

(909) 584-4521

Upon the request of the NPDES permitting authority, you must submit any other information the authority deems necessary to assess sewage sludge use or disposal practices at your facility and identify appropriate permitting requirements.

General Information Continued

PART 2, SECTION 2. GENERATION OF SEWAGE SLUDGE OR PREPARATION OF A MATERIAL DERIVED FROM SEWAGE SLUDGE (40 CFR 122.21(q)(8) THROUGH (12))

Generation of Sewage Sludge or Preparation of a Material Derived from Sewage Sludge

2.1	Does your facility generate sewage sludge or derive a material from sewage sludge? <input checked="" type="checkbox"/> Yes <input type="checkbox"/> No → SKIP to Part 2, Section 3.		
Amount Generated Onsite			
2.2	Total dry metric tons per 365-day period generated at your facility:		610
Amount Received from Off Site Facility			
2.3	Does your facility receive sewage sludge from another facility for treatment use or disposal? <input type="checkbox"/> Yes <input checked="" type="checkbox"/> No → SKIP to Item 2.8 (Part 2, Section 2) below.		
2.4	Indicate the total number of facilities from which you receive sewage sludge for treatment, use, or disposal:		
Provide the following information for each of the facilities from which you receive sewage sludge. <input type="checkbox"/> Check here if you have attached additional sheets to the application package.			
2.5	Name of facility		
	Mailing address (street or P.O. box)		
	City or town	State	ZIP code
	Contact name (first and last)	Title	Phone number Email address
	Location address (street, route number, or other specific identifier)		<input type="checkbox"/> Same as mailing address
	City or town	State	ZIP code
	County	County code	<input type="checkbox"/> Not available
2.6	Indicate the amount of sewage sludge received, the applicable pathogen class and reduction alternative, and the applicable vector reduction option provided at the offsite facility.		
	Amount (dry metric tons)	Pathogen Class and Reduction Alternative	Vector Attraction Reduction Option
		<input type="checkbox"/> Not applicable <input type="checkbox"/> Class A, Alternative 1 <input type="checkbox"/> Class A, Alternative 2 <input type="checkbox"/> Class A, Alternative 3 <input type="checkbox"/> Class A, Alternative 4 <input type="checkbox"/> Class A, Alternative 5 <input type="checkbox"/> Class A, Alternative 6 <input type="checkbox"/> Class B, Alternative 1 <input type="checkbox"/> Class B, Alternative 2 <input type="checkbox"/> Class B, Alternative 3 <input type="checkbox"/> Class B, Alternative 4 <input type="checkbox"/> Domestic septage, pH adjustment	<input type="checkbox"/> Not applicable <input type="checkbox"/> Option 1 <input type="checkbox"/> Option 2 <input type="checkbox"/> Option 3 <input type="checkbox"/> Option 4 <input type="checkbox"/> Option 5 <input type="checkbox"/> Option 6 <input type="checkbox"/> Option 7 <input type="checkbox"/> Option 8 <input type="checkbox"/> Option 9 <input type="checkbox"/> Option 10 <input type="checkbox"/> Option 11
2.7	Identify the treatment process(es) that are known to occur at the offsite facility, including blending activities and treatment to reduce pathogens or vector attraction properties. (Check all that apply.)		
	<input type="checkbox"/> Preliminary operations (e.g., sludge grinding and degritting) <input type="checkbox"/> Thickening (concentration) <input type="checkbox"/> Stabilization <input type="checkbox"/> Anaerobic digestion <input type="checkbox"/> Composting <input type="checkbox"/> Conditioning <input type="checkbox"/> Disinfection (e.g., beta ray irradiation, gamma ray irradiation, pasteurization) <input type="checkbox"/> Dewatering (e.g., centrifugation, sludge drying beds, sludge lagoons) <input type="checkbox"/> Heat drying <input type="checkbox"/> Thermal reduction <input type="checkbox"/> Methane or biogas capture and recovery <input type="checkbox"/> Other (specify) _____		

Generation of Sewage Sludge or Preparation of a Material Derived from Sewage Sludge Continued

Treatment Provided at Your Facility

2.8	For each sewage sludge use or disposal practice, indicate the applicable pathogen class and reduction alternative and the applicable vector attraction reduction option provided at your facility. Attach additional pages, as necessary.		
	Use or Disposal Practice (check one)	Pathogen Class and Reduction Alternative	Vector Attraction Reduction Option
	<input type="checkbox"/> Land application of bulk sewage <input type="checkbox"/> Land application of biosolids (bulk) <input type="checkbox"/> Land application of biosolids (bags) <input type="checkbox"/> Surface disposal in a landfill <input checked="" type="checkbox"/> Other surface disposal <input type="checkbox"/> Incineration	<input type="checkbox"/> Not applicable <input type="checkbox"/> Class A, Alternative 1 <input type="checkbox"/> Class A, Alternative 2 <input type="checkbox"/> Class A, Alternative 3 <input type="checkbox"/> Class A, Alternative 4 <input type="checkbox"/> Class A, Alternative 5 <input type="checkbox"/> Class A, Alternative 6 <input type="checkbox"/> Class B, Alternative 1 <input checked="" type="checkbox"/> Class B, Alternative 2 <input type="checkbox"/> Class B, Alternative 3 <input type="checkbox"/> Class B, Alternative 4 <input type="checkbox"/> Domestic septage, pH adjustment	<input type="checkbox"/> Not applicable <input type="checkbox"/> Option 1 <input type="checkbox"/> Option 2 <input type="checkbox"/> Option 3 <input type="checkbox"/> Option 4 <input type="checkbox"/> Option 5 <input type="checkbox"/> Option 6 <input type="checkbox"/> Option 7 <input type="checkbox"/> Option 8 <input type="checkbox"/> Option 9 <input checked="" type="checkbox"/> Option 10 <input type="checkbox"/> Option 11

2.9	Identify the treatment process(es) used at your facility to reduce pathogens in sewage sludge or reduce the vector attraction properties of sewage sludge? (Check all that apply.)	
	<input checked="" type="checkbox"/> Preliminary operations (e.g., sludge grinding and degritting) <input type="checkbox"/> Stabilization <input type="checkbox"/> Composting <input type="checkbox"/> Disinfection (e.g., beta ray irradiation, gamma ray irradiation, pasteurization) <input type="checkbox"/> Heat drying <input type="checkbox"/> Methane or biogas capture and recovery	<input type="checkbox"/> Thickening (concentration) <input type="checkbox"/> Anaerobic digestion <input type="checkbox"/> Conditioning <input checked="" type="checkbox"/> Dewatering (e.g., centrifugation, sludge drying beds, sludge lagoons) <input type="checkbox"/> Thermal reduction

2.10	Describe any other sewage sludge treatment or blending activities not identified in Items 2.8 and 2.9 (Part 2, Section 2) above. <input type="checkbox"/> Check here if you have attached the description to the application package.
------	------------------------------------------------------------------------------------------------------------------------------------------------------------------------------------------------------------------------------------------

Preparation of Sewage Sludge Meeting Ceiling and Pollutant Concentrations, Class A Pathogen Requirements, and One of Vector Attraction Reduction Options 1 to 8

2.11	Does the sewage sludge from your facility meet the ceiling concentrations in Table 1 of 40 CFR 503.13, the pollutant concentrations in Table 3 of 40 CFR 503.13, Class A pathogen reduction requirements at 40 CFR 503.32(a), and one of the vector attraction reduction requirements at 40 CFR 503.33(b)(1)–(8) and is it land applied? <input type="checkbox"/> Yes <input checked="" type="checkbox"/> No → SKIP to Item 2.14 (Part 2, Section 2) below.
------	-------------------------------------------------------------------------------------------------------------------------------------------------------------------------------------------------------------------------------------------------------------------------------------------------------------------------------------------------------------------------------------------------------------------------------------------------------------------

2.12	Total dry metric tons per 365-day period of sewage sludge subject to this subsection that is applied to the land:	
------	-------------------------------------------------------------------------------------------------------------------	--

2.13	Is sewage sludge subject to this subsection placed in bags or other containers for sale or give-away for application to the land? <input type="checkbox"/> Yes <input type="checkbox"/> No
------	--------------------------------------------------------------------------------------------------------------------------------------------------------------------------------------------------

Check here once you have completed Items 2.11 to 2.13, then → SKIP to Item 2.32 (Part 2, Section 2) below.

EPA Identification Number		NPDES Permit Number CA8000344		Facility Name Big Bear City RTP		Form Approved 03/05/19 OMB No. 2040-0004	
Generation of Sewage Sludge or Preparation of a Material Derived from Sewage Sludge Continued	Sale or Give-Away in a Bag or Other Container for Application to the Land						
	2.14	Do you place sewage sludge in a bag or other container for sale or give-away for land application? <input type="checkbox"/> Yes <input checked="" type="checkbox"/> No → SKIP to Item 2.17 (Part 2, Section 2) below.					
	2.15	Total dry metric tons per 365-day period of sewage sludge placed in a bag or other container at your facility for sale or give-away for application to the land:					
	2.16	Attach a copy of all labels or notices that accompany the sewage sludge being sold or given away in a bag or other container for application to the land. <input type="checkbox"/> Check here to indicate that you have attached all labels or notices to this application package.					
	<input checked="" type="checkbox"/> Check here once you have completed Items 2.14 to 2.16, then → SKIP to Part 2, Section 2, Item 2.32.						
	Shipment Off Site for Treatment or Blending						
	2.17	Does another facility provide treatment or blending of your facility's sewage sludge? (This question does not pertain to dewatered sludge sent directly to a land application or surface disposal site.) <input checked="" type="checkbox"/> Yes <input type="checkbox"/> No → SKIP to Item 2.32 (Part 2, Section 2) below.					
	2.18	Indicate the total number of facilities that provide treatment or blending of your facility's sewage sludge. Provide the information in Items 2.19 to 2.26 (Part 2, Section 2) below for each facility. <input checked="" type="checkbox"/> Check here if you have attached additional sheets to the application package.					1 primary, 1 backup
	2.19	Name of receiving facility Nursery Products Hawes Composting Facility					
		Mailing address (street or P.O. box) 14479 Cougar Rd					
		City or town Helendale			State CA		ZIP code 92342
		Contact name (first and last) Venny Vasquez		Title Site Manager	Phone number (760) 265-5210		Email address vvasquez@synagro.com
		Location address (street, route number, or other specific identifier)					<input checked="" type="checkbox"/> Same as mailing address
		City or town			State		ZIP code
2.20	Total dry metric tons per 365-day period of sewage sludge provided to receiving facility:					610	
2.21	Does the receiving facility provide additional treatment to reduce pathogens in sewage sludge from your facility or reduce the vector attraction properties of sewage sludge from your facility? <input checked="" type="checkbox"/> Yes <input type="checkbox"/> No → SKIP to Item 2.24 (Part 2, Section 2) below.						
2.22	Indicate the pathogen class and reduction alternative and the vector attraction reduction option met for the sewage sludge at the receiving facility.						
	Pathogen Class and Reduction Alternative			Vector Attraction Reduction Option			
<input type="checkbox"/> Not applicable			<input type="checkbox"/> Not applicable				
<input type="checkbox"/> Class A, Alternative 1			<input type="checkbox"/> Option 1				
<input type="checkbox"/> Class A, Alternative 2			<input type="checkbox"/> Option 2				
<input type="checkbox"/> Class A, Alternative 3			<input type="checkbox"/> Option 3				
<input type="checkbox"/> Class A, Alternative 4			<input type="checkbox"/> Option 4				
<input checked="" type="checkbox"/> Class A, Alternative 5			<input checked="" type="checkbox"/> Option 5				
<input type="checkbox"/> Class A, Alternative 6			<input type="checkbox"/> Option 6				
<input type="checkbox"/> Class B, Alternative 1			<input type="checkbox"/> Option 7				
<input type="checkbox"/> Class B, Alternative 2			<input type="checkbox"/> Option 8				
<input type="checkbox"/> Class B, Alternative 3			<input type="checkbox"/> Option 9				
<input type="checkbox"/> Class B, Alternative 4			<input type="checkbox"/> Option 10				
<input type="checkbox"/> Domestic septage, pH adjustment			<input type="checkbox"/> Option 11				

EPA Identification Number	NPDES Permit Number CA8000344	Facility Name Big Bear City RTP	Form Approved 03/05/19 OMB No. 2040-0004
Generation of Sewage Sludge or Preparation of a Material Derived from Sewage Sludge Continued	2.23	Which treatment process(es) are used at the receiving facility to reduce pathogens in sewage sludge or reduce the vector attraction properties of sewage sludge from your facility? (Check all that apply.)	
		<input type="checkbox"/> Preliminary operations (e.g., sludge grinding and dewatering)	<input type="checkbox"/> Thickening (concentration)
		<input type="checkbox"/> Stabilization	<input type="checkbox"/> Anaerobic digestion
		<input checked="" type="checkbox"/> Composting	<input type="checkbox"/> Conditioning
		<input type="checkbox"/> Disinfection (e.g., beta ray irradiation, gamma ray irradiation, pasteurization)	<input type="checkbox"/> Dewatering (e.g., centrifugation, sludge drying beds, sludge lagoons)
		<input type="checkbox"/> Heat drying	<input type="checkbox"/> Thermal reduction
		<input type="checkbox"/> Methane or biogas capture and recovery	<input type="checkbox"/> Other (specify) _____
	2.24	Attach a copy of any information you provide the receiving facility to comply with the "notice and necessary information" requirement of 40 CFR 503.12(g).	
		<input type="checkbox"/> Check here to indicate that you have attached material.	
	2.25	Does the receiving facility place sewage sludge from your facility in a bag or other container for sale or give-away for application to the land?	
		<input type="checkbox"/> Yes	<input checked="" type="checkbox"/> No → SKIP to Item 2.32 (Part 2, Section 2) below.
	2.26	Attach a copy of all labels or notices that accompany the product being sold or given away.	
		<input type="checkbox"/> Check here to indicate that you have attached material.	
		<input checked="" type="checkbox"/> Check here once you have completed Items 2.17 to 2.26 (Part 2, Section 2), then → SKIP to Item 2.32 (Part 2, Section 2) below. [See additional pages for backup receiving facility.]	
Land Application of Bulk Sewage Sludge			
2.27	Is sewage sludge from your facility applied to the land?		
	<input type="checkbox"/> Yes	<input checked="" type="checkbox"/> No → SKIP to Item 2.32 (Part 2, Section 2) below.	
2.28	Total dry metric tons per 365-day period of sewage sludge applied to all land application sites:		
2.29	Did you identify all land application sites in Part 2, Section 3 of this application?		
	<input type="checkbox"/> Yes	<input type="checkbox"/> No → Submit a copy of the land application plan with your application.	
2.30	Are any land application sites located in states other than the state where you generate sewage sludge or derive a material from sewage sludge?		
	<input type="checkbox"/> Yes	<input type="checkbox"/> No → SKIP to Item 2.32 (Part 2, Section 2) below.	
2.31	Describe how you notify the NPDES permitting authority for the states where the land application sites are located. Attach a copy of the notification.		
	<input type="checkbox"/> Check here if you have attached the explanation to the application package.		
	<input type="checkbox"/> Check here if you have attached the notification to the application package.		
Surface Disposal			
2.32	Is sewage sludge from your facility placed on a surface disposal site?		
	<input type="checkbox"/> Yes	<input checked="" type="checkbox"/> No → SKIP to Item 2.39 (Part 2, Section 2) below.	
2.33	Total dry metric tons of sewage sludge from your facility placed on all surface disposal sites per 365-day period:		
2.34	Do you own or operate all surface disposal sites to which you send sewage sludge for disposal?		
	<input type="checkbox"/> Yes → SKIP to Item 2.39 (Part 2, Section 2) below.	<input type="checkbox"/> No	
2.35	Indicate the total number of surface disposal sites to which you send your sewage sludge. (Provide the information in Items 2.36 to 2.38 of Part 2, Section 2, for each facility.)		
	<input type="checkbox"/> Check here if you have attached additional sheets to the application package.		

EPA Identification Number		NPDES Permit Number CA8000344		Facility Name Big Bear City RTP		Form Approved 03/05/19 OMB No. 2040-0004		
Generation of Sewage Sludge or Preparation of a Material Derived from Sewage Sludge Continued	2.36	Site name or number of surface disposal site you do not own or operate						
		Mailing address (street or P.O. box)						
		City or Town			State		ZIP Code	
		Contact Name (first and last)		Title		Phone Number		Email Address
	2.37	Site Contact (Check all that apply.) <input type="checkbox"/> Owner <input type="checkbox"/> Operator						
	2.38	Total dry metric tons of sewage sludge from your facility placed on this surface disposal site per 365-day period:						
	Incineration							
	2.39	Is sewage sludge from your facility fired in a sewage sludge incinerator? <input type="checkbox"/> Yes <input checked="" type="checkbox"/> No → SKIP to Item 2.46 (Part 2, Section 2) below.						
	2.40	Total dry metric tons of sewage sludge from your facility fired in all sewage sludge incinerators per 365-day period:						
	2.41	Do you own or operate all sewage sludge incinerators in which sewage sludge from your facility is fired? <input type="checkbox"/> Yes → SKIP to Item 2.46 (Part 2, Section 2) below. <input type="checkbox"/> No						
	2.42	Indicate the total number of sewage sludge incinerators used that you do not own or operate. (Provide the information in Items 2.43 to 2.45 directly below for each facility.) <input type="checkbox"/> Check here if you have attached additional sheets to the application package.						
	2.43	Incinerator name or number						
		Mailing address (street or P.O. box)						
		City or town			State		ZIP code	
		Contact name (first and last)		Title		Phone number		Email address
		Location address (street, route number, or other specific identifier)						<input type="checkbox"/> Same as mailing address
		City or town			State		ZIP code	
	2.44	Contact (check all that apply) <input type="checkbox"/> Incinerator owner <input type="checkbox"/> Incinerator operator						
2.45	Total dry metric tons of sewage sludge from your facility fired in this sewage sludge incinerator per 365-day period:							
Disposal in a Municipal Solid Waste Landfill								
2.46	Is sewage sludge from your facility placed on a municipal solid waste landfill? <input type="checkbox"/> Yes <input checked="" type="checkbox"/> No → SKIP to Part 2, Section 3.							
2.47	Indicate the total number of municipal solid waste landfills used. (Provide the information in Items 2.48 to 2.52 directly below for each facility.) <input type="checkbox"/> Check here if you have attached additional sheets to the application package.							

EPA Identification Number		NPDES Permit Number CA8000344		Facility Name Big Bear City RTP		Form Approved 03/05/19 OMB No. 2040-0004		
Generation of Sewage Sludge or Preparation of a Material Derived from Sewage Sludge Continued	2.48	Name of landfill						
		Mailing address (street or P.O. box)						
		City or town			State		ZIP code	
		Contact name (first and last)		Title		Phone number	Email address	
		Location address (street, route number, or other specific identifier)						<input type="checkbox"/> Same as mailing address
		County			County code			<input type="checkbox"/> Not available
		City or town			State		ZIP code	
	2.49	Total dry metric tons of sewage sludge from your facility placed in this municipal solid waste landfill per 365-day period:						
	2.50	List the numbers of all other federal, state, and local permits that regulate the operation of this municipal solid waste landfill.						
		Permit Number		Type of Permit				
2.51	Attach to the application information to determine whether the sewage sludge meets applicable requirements for disposal of sewage sludge in a municipal solid waste landfill (e.g., results of paint filter liquids test and TCLP test). <input type="checkbox"/> Check here to indicate you have attached the requested information.							
2.52	Does the municipal solid waste landfill comply with applicable criteria set forth in 40 CFR 258? <input type="checkbox"/> Yes <input type="checkbox"/> No							

PART 2, SECTION 3 LAND APPLICATION OF BULK SEWAGE SLUDGE (40 CFR 122.21(q)(9))

Land Application of Bulk Sewage Sludge

3.1	Does your facility apply sewage sludge to land? <input type="checkbox"/> Yes <input checked="" type="checkbox"/> No → SKIP to Part 2, Section 4.		
3.2	Do any of the following conditions apply? <ul style="list-style-type: none"> The sewage sludge meets the ceiling concentrations in Table 1 of 40 CFR 503.12, the pollutant concentrations in Table 3 of 40 CFR 503.13, Class A pathogen reduction requirements at 40 CFR 503.32(a), and one of the vector attraction reduction requirements at 40 CFR 503.33(b)(1)–(8); The sewage sludge is sold or given away in a bag or other container for application to the land; or You provide the sewage sludge to another facility for treatment or blending. <input type="checkbox"/> Yes → SKIP to Part 2, Section 4. <input type="checkbox"/> No		
3.3	Complete Section 3 for every site on which the sewage sludge is applied. <input type="checkbox"/> Check here if you have attached sheets to the application package for one or more land application sites.		
Identification of Land Application Site			
3.4	Site name or number		
	Location address (street, route number, or other specific identifier)		<input type="checkbox"/> Same as mailing address
	County	County code	<input type="checkbox"/> Not available
	City or town	State	ZIP code
Latitude/Longitude of Land Application Site (see instructions)			
	Latitude		Longitude
	. ' "		. ' "
Method of Determination			
	<input type="checkbox"/> USGS map	<input type="checkbox"/> Field survey	<input type="checkbox"/> Other (specify) _____
3.5	Provide a topographic map (or other appropriate map if a topographic map is unavailable) that shows the site location. <input type="checkbox"/> Check here to indicate you have attached a topographic map for this site.		
Owner Information			
3.6	Are you the owner of this land application site? <input type="checkbox"/> Yes → SKIP to Item 3.8 (Part 2, Section 3) below. <input type="checkbox"/> No		
3.7	Owner name		
	Mailing address (street or P.O. box)		
	City or town	State	ZIP code
	Contact name (first and last)	Title	Phone number Email address
Applier Information			
3.8	Are you the person who applies, or who is responsible for application of, sewage sludge to this land application site? <input type="checkbox"/> Yes → SKIP to Item 3.10 (Part 2, Section 3) below. <input type="checkbox"/> No		
3.9	Applier's name		
	Mailing address (street or P.O. box)		
	City or town	State	ZIP code
	Contact name (first and last)	Title	Phone number Email address

Land Application of Bulk Sewage Sludge Continued	Site Type		
	3.10	Type of land application:	<input type="checkbox"/> Agricultural land <input type="checkbox"/> Forest <input type="checkbox"/> Reclamation site <input type="checkbox"/> Public contact site <input type="checkbox"/> Other (describe)
	Crop or Other Vegetation Grown on Site		
	3.11	What type of crop or other vegetation is grown on this site?	
	3.12	What is the nitrogen requirement for this crop or vegetation?	
	Vector Attraction Reduction		
	3.13	Are the vector attraction reduction requirements at 40 CFR 503.33(b)(9) and (b)(10) met when sewage sludge is applied to the land application site? <input type="checkbox"/> Yes <input type="checkbox"/> No → SKIP to Item 3.16 (Part 2, Section 3) below.	
	3.14	Indicate which vector attraction reduction option is met. (Check only one response.) <input type="checkbox"/> Option 9 (injection below land surface) <input type="checkbox"/> Option 10 (incorporation into soil within 6 hours)	
	3.15	Describe any treatment processes used at the land application site to reduce vector attraction properties of sewage sludge. <input type="checkbox"/> Check here if you have attached your description to the application package.	
	Cumulative Loadings and Remaining Allotments		
	3.16	Is the sewage sludge applied to this site since July 20, 1993, subject to the cumulative pollutant loading rates (CPLRs) in 40 CFR 503.13(b)(2)? <input type="checkbox"/> Yes <input type="checkbox"/> No → SKIP to Part 2, Section 4.	
	3.17	Have you contacted the NPDES permitting authority in the state where the bulk sewage sludge subject to CPLRs will be applied to ascertain whether bulk sewage sludge subject to CPLRs has been applied to this site on or since July 20, 1993? <input type="checkbox"/> Yes <input type="checkbox"/> No → Sewage sludge subject to CPLRs may not be applied to this site. SKIP to Part 2, Section 4.	
	3.18	Provide the following information about your NPDES permitting authority:	
		NPDES permitting authority name	
		Contact person	
	Telephone number		
	Email address		
3.19	Based on your inquiry, has bulk sewage sludge subject to CPLRs been applied to this site since July 20, 1993? <input type="checkbox"/> Yes <input type="checkbox"/> No → SKIP to Part 2, Section 4.		
3.20	Provide the following information for every facility other than yours that is sending, or has sent, bulk sewage sludge subject to CPLRs to this site since July 20, 1993. If more than one such facility sends sewage sludge to this site, attach additional pages as necessary. <input type="checkbox"/> Check here to indicate that additional pages are attached.		
	Facility name		
	Mailing address (street or P.O. box)		
	City or town	State ZIP code	
	Contact name (first and last)	Title Phone number Email address	

PART 2, SECTION 4 SURFACE DISPOSAL (40 CFR 122.21(q)(10))

Surface Disposal	4.1	Do you own or operate a surface disposal site? <input type="checkbox"/> Yes <input checked="" type="checkbox"/> No → SKIP to Part 2, Section 5.		
	4.2	Complete all items in Section 4 for each active sewage sludge unit that you own or operate. <input type="checkbox"/> Check here to indicate that you have attached material to the application package for one or more active sewage sludge units.		
	Information on Active Sewage Sludge Units			
	4.3	Unit name or number		
		Mailing address (street or P.O. box)		
		City or town	State	ZIP code
		Contact name (first and last)	Title	Phone number Email address
		Location address (street, route number, or other specific identifier)		<input type="checkbox"/> Same as mailing address
		County	County code	<input type="checkbox"/> Not available
		City or town	State	ZIP code
		Latitude/Longitude of Active Sewage Sludge Unit (see instructions)		
		Latitude	Longitude	
		° ' "	° ' "	
		Method of Determination		
	<input type="checkbox"/> USGS map <input type="checkbox"/> Field survey <input type="checkbox"/> Other (specify) _____			
4.4	Provide a topographic map (or other appropriate map if a topographic map is unavailable) that shows the site location. <input type="checkbox"/> Check here to indicate that you have completed and attached a topographic map.			
4.5	Total dry metric tons of sewage sludge placed on the active sewage sludge unit per 365-day period:			
4.6	Total dry metric tons of sewage sludge placed on the active sewage sludge unit over the life of the unit:			
4.7	Does the active sewage sludge unit have a liner with a maximum permeability of 1×10^{-7} centimeters per second (cm/sec)? <input type="checkbox"/> Yes <input type="checkbox"/> No → SKIP to Item 4.9 (Part 2, Section 4) below.			
4.8	Describe the liner. <input type="checkbox"/> Check here to indicate that you have attached a description to the application package.			
4.9	Does the active sewage sludge unit have a leachate collection system? <input type="checkbox"/> Yes <input type="checkbox"/> No → SKIP to Item 4.11 (Part 2, Section 4) below.			
4.10	Describe the leachate collection system and the method used for leachate disposal and provide the numbers of any federal, state, or local permit(s) for leachate disposal. <input type="checkbox"/> Check here to indicate that you have attached the description to the application package.			

Surface Disposal Continued

4.11	Is the boundary of the active sewage sludge unit less than 150 meters from the property line of the surface disposal site?		
	<input type="checkbox"/> Yes	<input type="checkbox"/> No → SKIP to Item 4.13 (Part 2, Section 4) below.	
4.12	Provide the actual distance in meters:	meters	
4.13	Remaining capacity of active sewage sludge unit in dry metric tons:	dry metric tons	
4.14	Anticipated closure date for active sewage sludge unit, if known (MM/DD/YYYY):		
4.15	Attach a copy of any closure plan that has been developed for this active sewage sludge unit. <input type="checkbox"/> Check here to indicate that you have attached a copy of the closure plan to the application package.		
Sewage Sludge from Other Facilities			
4.16	Is sewage sludge sent to this active sewage sludge unit from any facilities other than your facility?		
	<input type="checkbox"/> Yes	<input type="checkbox"/> No → SKIP to Item 4.21 (Part 2, Section 4) below.	
4.17	Indicate the total number of facilities (other than your facility) that send sewage sludge to this active sewage sludge unit. (Complete Items 4.18 to 4.20 directly below for each such facility.) <input type="checkbox"/> Check here to indicate that you have attached responses for each facility to the application package.		
4.18	Facility name		
	Mailing address (street or P.O. box)		
	City or town	State	ZIP code
	Contact name (first and last)	Title	Phone number Email address
4.19	Indicate the pathogen class and reduction alternative and the vector attraction reduction option met for the sewage sludge before leaving the other facility.		
	Pathogen Class and Reduction Alternative	Vector Attraction Reduction Option	
	<input type="checkbox"/> Not applicable	<input type="checkbox"/> Not applicable	
	<input type="checkbox"/> Class A, Alternative 1	<input type="checkbox"/> Option 1	
	<input type="checkbox"/> Class A, Alternative 2	<input type="checkbox"/> Option 2	
	<input type="checkbox"/> Class A, Alternative 3	<input type="checkbox"/> Option 3	
	<input type="checkbox"/> Class A, Alternative 4	<input type="checkbox"/> Option 4	
	<input type="checkbox"/> Class A, Alternative 5	<input type="checkbox"/> Option 5	
	<input type="checkbox"/> Class A, Alternative 6	<input type="checkbox"/> Option 6	
	<input type="checkbox"/> Class B, Alternative 1	<input type="checkbox"/> Option 7	
	<input type="checkbox"/> Class B, Alternative 2	<input type="checkbox"/> Option 8	
	<input type="checkbox"/> Class B, Alternative 3	<input type="checkbox"/> Option 9	
	<input type="checkbox"/> Class B, Alternative 4	<input type="checkbox"/> Option 10	
	<input type="checkbox"/> Domestic septage, pH adjustment	<input type="checkbox"/> Option 11	
4.20	Which treatment process(es) are used at the other facility to reduce pathogens in sewage sludge or reduce the vector attraction properties of sewage sludge before leaving the other facility? (Check all that apply.)		
	<input type="checkbox"/> Preliminary operations (e.g., sludge grinding and degritting)	<input type="checkbox"/> Thickening (concentration)	
	<input type="checkbox"/> Stabilization	<input type="checkbox"/> Anaerobic digestion	
	<input type="checkbox"/> Composting	<input type="checkbox"/> Conditioning	
	<input type="checkbox"/> Disinfection (e.g., beta ray irradiation, gamma ray irradiation, pasteurization)	<input type="checkbox"/> Dewatering (e.g., centrifugation, sludge drying beds, sludge lagoons)	
	<input type="checkbox"/> Heat drying	<input type="checkbox"/> Thermal reduction	
	<input type="checkbox"/> Methane or biogas capture and recovery	<input type="checkbox"/> Other (specify) _____	

EPA Identification Number		NPDES Permit Number CA8000344	Facility Name Big Bear City RTP	Form Approved 03/05/19 OMB No. 2040-0004
Surface Disposal Continued	Vector Attraction Reduction			
	4.21	Which vector attraction reduction option, if any, is met when sewage sludge is placed on this active sewage sludge unit?		
		<input type="checkbox"/> Option 9 (Injection below and surface)	<input type="checkbox"/> Option 11 (Covering active sewage sludge unit daily)	
		<input type="checkbox"/> Option 10 (Incorporation into soil within 6 hours)	<input type="checkbox"/> None	
	4.22	Describe any treatment processes used at the active sewage sludge unit to reduce vector attraction properties of sewage sludge.		
		<input type="checkbox"/> Check here if you have attached your description to the application package.		
	Groundwater Monitoring			
	4.23	Is groundwater monitoring currently conducted at this active sewage sludge unit, or are groundwater monitoring data otherwise available for this active sewage sludge unit?		
		<input type="checkbox"/> Yes	<input type="checkbox"/> No → SKIP to Item 4.26 (Part 2, Section 4) below.	
	4.24	Provide a copy of available groundwater monitoring data.		
		<input type="checkbox"/> Check here to indicate you have attached the monitoring data.		
	4.25	Describe the well locations, the approximate depth to groundwater, and the groundwater monitoring procedures used to obtain these data.		
		<input type="checkbox"/> Check here if you have attached your description to the application package.		
	4.26	Has a groundwater monitoring program been prepared for this active sewage sludge unit?		
	<input type="checkbox"/> Yes	<input type="checkbox"/> No → SKIP to Item 4.28 (Part 2, Section 4) below.		
4.27	Submit a copy of the groundwater monitoring program with this permit application.			
	<input type="checkbox"/> Check here to indicate you have attached the monitoring program.			
4.28	Have you obtained a certification from a qualified groundwater scientist that the aquifer below the active sewage sludge unit has not been contaminated?			
	<input type="checkbox"/> Yes	<input type="checkbox"/> No → SKIP to Item 4.30 (Part 2, Section 4) below.		
4.29	Submit a copy of the certification with this permit application.			
	<input type="checkbox"/> Check here to indicate you have attached the certification to the application package.			
Site-Specific Limits				
4.30	Are you seeking site-specific pollutant limits for the sewage sludge placed on the active sewage sludge unit?			
	<input type="checkbox"/> Yes	<input type="checkbox"/> No → SKIP to Part 2, Section 5.		
4.31	Submit information to support the request for site-specific pollutant limits with this application.			
	<input type="checkbox"/> Check here to indicate you have attached the requested information.			

PART 2, SECTION 5 INCINERATION (40 CFR 122.21(q)(11))**Incinerator Information**

5.1 Do you fire sewage sludge in a sewage sludge incinerator?

 Yes No → SKIP to END.

5.2 Indicate the total number of incinerators used at your facility. (Complete the remainder of Section 5 for each such incinerator.)

 Check here to indicate that you have attached information for one or more incinerators.

5.3 Incinerator name or number

Location address (street, route number, or other specific identifier)

County

County code

 Not available

City or town

State

ZIP code

Latitude/Longitude of Incinerator (see instructions)**Latitude****Longitude**

°

'

"

°

'

"

Method of Determination USGS map Field survey Other (specify) _____**Amount Fired**

5.4 Dry metric tons per 365-day period of sewage sludge fired in the sewage sludge incinerator:

Beryllium NESHAP

5.5 Submit information, test data, and a description of measures taken that demonstrate whether the sewage sludge incinerated is beryllium-containing waste and will continue to remain as such.

 Check here to indicate that you have attached this material to the application package.

5.6 Is the sewage sludge fired in this incinerator "beryllium-containing waste" as defined at 40 CFR 61.31?

 Yes No → SKIP to Item 5.8 (Part 2, Section 5) below.

5.7 Submit with this application a complete report of the latest beryllium emission rate testing and documentation of ongoing incinerator operating parameters indicating that the NESHAP emission rate limit for beryllium has been and will continue to be met.

 Check here to indicate that you have attached this information.**Mercury NESHAP**

5.8 Is compliance with the mercury NESHAP being demonstrated via stack testing?

 Yes No → SKIP to Item 5.11 (Part 2, Section 5) below.

5.9 Submit a complete report of stack testing and documentation of ongoing incinerator operating parameters indicating that the incinerator has met and will continue to meet the mercury NESHAP emission rate limit.

 Check here to indicate that you have attached this information.

5.10 Provide copies of mercury emission rate tests for the two most recent years in which testing was conducted.

 Check here to indicate that you have attached this information.

5.11 Do you demonstrate compliance with the mercury NESHAP by sewage sludge sampling?

 Yes No → SKIP to Item 5.13 (Part 2, Section 5) below.

5.12 Submit a complete report of sewage sludge sampling and documentation of ongoing incinerator operating parameters indicating that the incinerator has met and will continue to meet the mercury NESHAP emission rate limit.

 Check here to indicate that you have attached this information.

Incineration

Dispersion Factor

5.13	Dispersion factor in micrograms/cubic meter per gram/second:	
5.14	Name and type of dispersion model:	
5.15	Submit a copy of the modeling results and supporting documentation. <input type="checkbox"/> Check here to indicate that you have attached this information.	

Control Efficiency

5.16	Provide the control efficiency, in hundredths, for each of the pollutants listed below.	
	Pollutant	Control Efficiency, in Hundredths
	Arsenic	
	Cadmium	
	Chromium	
	Lead	
	Nickel	
5.17	Attach a copy of the results or performance testing and supporting documentation (including testing dates). <input type="checkbox"/> Check here to indicate that you have attached this information.	

Risk-Specific Concentration for Chromium

5.18	Provide the risk-specific concentration (RSC) used for chromium in micrograms per cubic meter:	
5.19	Was the RSC determined via Table 2 in 40 CFR 503.43? <input type="checkbox"/> Yes <input type="checkbox"/> No → SKIP to Item 5.21 (Part 2, Section 5) below.	
5.20	Identify the type of incinerator used as the basis. <input type="checkbox"/> Fluidized bed with wet scrubber <input type="checkbox"/> Other types with wet scrubber <input type="checkbox"/> Fluidized bed with wet scrubber and wet electrostatic precipitator <input type="checkbox"/> Other types with wet scrubber and wet electrostatic precipitator	
5.21	Was the RSC determined via Table 6 in 40 CFR 503.43 (site-specific determination)? <input type="checkbox"/> Yes <input type="checkbox"/> No → SKIP to Item 5.23 (Part 2, Section 5) below.	
5.22	Provide the decimal fraction of hexavalent chromium concentration to total chromium concentration in stack exit gas:	
5.23	Attach the results of incinerator stack tests for hexavalent and total chromium concentrations, including the date(s) of any test(s), with this application. <input type="checkbox"/> Check here to indicate that you have attached this information. <input type="checkbox"/> Not applicable	

Incinerator Parameters

5.24	Do you monitor total hydrocarbons (THC) in the exit gas of the sewage sludge incinerator? <input type="checkbox"/> Yes <input type="checkbox"/> No	
5.25	Do you monitor carbon monoxide (CO) in the exit gas of the sewage sludge incinerator? <input type="checkbox"/> Yes <input type="checkbox"/> No	
5.26	Indicate the type of sewage sludge incinerator.	
5.27	Incinerator stack height in meters:	
5.28	Indicate whether the value submitted in Item 5.27 is (check only one response): <input type="checkbox"/> Actual stack height <input type="checkbox"/> Creditable stack height	

Incineration Continued

Generation of Sewage Sludge or Preparation of a Material Derived from Sewage Sludge Continued

Additional pages for backup receiving facility:

Shipment Off Site for Treatment or Blending

2.17	Does another facility provide treatment or blending of your facility's sewage sludge? (This question does not pertain to dewatered sludge sent directly to a land application or surface disposal site.) <input checked="" type="checkbox"/> Yes <input type="checkbox"/> No → SKIP to Item 2.32 (Part 2, Section 2) below.																											
2.18	Indicate the total number of facilities that provide treatment or blending of your facility's sewage sludge. Provide the information in Items 2.19 to 2.26 (Part 2, Section 2) below for each facility. <input checked="" type="checkbox"/> Check here if you have attached additional sheets to the application package.	1 primary, 1 backup																										
2.19	Name of receiving facility Arizona Soils Composting Facility Mailing address (street or P.O. box) 41326 McVey Road <table border="1" style="width:100%; border-collapse: collapse;"> <tr> <td style="width:45%;">City or town Vicksburg</td> <td style="width:15%;">State AZ</td> <td style="width:40%;">ZIP code 85348</td> </tr> <tr> <td>Contact name (first and last) Brian Millage</td> <td>Title Manager</td> <td>Phone number (623) 236-0974</td> </tr> <tr> <td colspan="2">Location address (street, route number, or other specific identifier)</td> <td><input checked="" type="checkbox"/> Same as mailing address</td> </tr> <tr> <td>City or town</td> <td>State</td> <td>ZIP code</td> </tr> </table>		City or town Vicksburg	State AZ	ZIP code 85348	Contact name (first and last) Brian Millage	Title Manager	Phone number (623) 236-0974	Location address (street, route number, or other specific identifier)		<input checked="" type="checkbox"/> Same as mailing address	City or town	State	ZIP code														
City or town Vicksburg	State AZ	ZIP code 85348																										
Contact name (first and last) Brian Millage	Title Manager	Phone number (623) 236-0974																										
Location address (street, route number, or other specific identifier)		<input checked="" type="checkbox"/> Same as mailing address																										
City or town	State	ZIP code																										
2.20	Total dry metric tons per 365-day period of sewage sludge provided to receiving facility:	Contingent																										
2.21	Does the receiving facility provide additional treatment to reduce pathogens in sewage sludge from your facility or reduce the vector attraction properties of sewage sludge from your facility? <input checked="" type="checkbox"/> Yes <input type="checkbox"/> No → SKIP to Item 2.24 (Part 2, Section 2) below.																											
2.22	Indicate the pathogen class and reduction alternative and the vector attraction reduction option met for the sewage sludge at the receiving facility.																											
	<table border="1" style="width:100%; border-collapse: collapse;"> <thead> <tr> <th style="width:50%;">Pathogen Class and Reduction Alternative</th> <th style="width:50%;">Vector Attraction Reduction Option</th> </tr> </thead> <tbody> <tr> <td><input type="checkbox"/> Not applicable</td> <td><input type="checkbox"/> Not applicable</td> </tr> <tr> <td><input type="checkbox"/> Class A, Alternative 1</td> <td><input type="checkbox"/> Option 1</td> </tr> <tr> <td><input type="checkbox"/> Class A, Alternative 2</td> <td><input type="checkbox"/> Option 2</td> </tr> <tr> <td><input type="checkbox"/> Class A, Alternative 3</td> <td><input type="checkbox"/> Option 3</td> </tr> <tr> <td><input type="checkbox"/> Class A, Alternative 4</td> <td><input type="checkbox"/> Option 4</td> </tr> <tr> <td><input checked="" type="checkbox"/> Class A, Alternative 5</td> <td><input checked="" type="checkbox"/> Option 5</td> </tr> <tr> <td><input type="checkbox"/> Class A, Alternative 6</td> <td><input type="checkbox"/> Option 6</td> </tr> <tr> <td><input type="checkbox"/> Class B, Alternative 1</td> <td><input type="checkbox"/> Option 7</td> </tr> <tr> <td><input type="checkbox"/> Class B, Alternative 2</td> <td><input type="checkbox"/> Option 8</td> </tr> <tr> <td><input type="checkbox"/> Class B, Alternative 3</td> <td><input type="checkbox"/> Option 9</td> </tr> <tr> <td><input type="checkbox"/> Class B, Alternative 4</td> <td><input type="checkbox"/> Option 10</td> </tr> <tr> <td><input type="checkbox"/> Domestic septage, pH adjustment</td> <td><input type="checkbox"/> Option 11</td> </tr> </tbody> </table>	Pathogen Class and Reduction Alternative	Vector Attraction Reduction Option	<input type="checkbox"/> Not applicable	<input type="checkbox"/> Not applicable	<input type="checkbox"/> Class A, Alternative 1	<input type="checkbox"/> Option 1	<input type="checkbox"/> Class A, Alternative 2	<input type="checkbox"/> Option 2	<input type="checkbox"/> Class A, Alternative 3	<input type="checkbox"/> Option 3	<input type="checkbox"/> Class A, Alternative 4	<input type="checkbox"/> Option 4	<input checked="" type="checkbox"/> Class A, Alternative 5	<input checked="" type="checkbox"/> Option 5	<input type="checkbox"/> Class A, Alternative 6	<input type="checkbox"/> Option 6	<input type="checkbox"/> Class B, Alternative 1	<input type="checkbox"/> Option 7	<input type="checkbox"/> Class B, Alternative 2	<input type="checkbox"/> Option 8	<input type="checkbox"/> Class B, Alternative 3	<input type="checkbox"/> Option 9	<input type="checkbox"/> Class B, Alternative 4	<input type="checkbox"/> Option 10	<input type="checkbox"/> Domestic septage, pH adjustment	<input type="checkbox"/> Option 11	
Pathogen Class and Reduction Alternative	Vector Attraction Reduction Option																											
<input type="checkbox"/> Not applicable	<input type="checkbox"/> Not applicable																											
<input type="checkbox"/> Class A, Alternative 1	<input type="checkbox"/> Option 1																											
<input type="checkbox"/> Class A, Alternative 2	<input type="checkbox"/> Option 2																											
<input type="checkbox"/> Class A, Alternative 3	<input type="checkbox"/> Option 3																											
<input type="checkbox"/> Class A, Alternative 4	<input type="checkbox"/> Option 4																											
<input checked="" type="checkbox"/> Class A, Alternative 5	<input checked="" type="checkbox"/> Option 5																											
<input type="checkbox"/> Class A, Alternative 6	<input type="checkbox"/> Option 6																											
<input type="checkbox"/> Class B, Alternative 1	<input type="checkbox"/> Option 7																											
<input type="checkbox"/> Class B, Alternative 2	<input type="checkbox"/> Option 8																											
<input type="checkbox"/> Class B, Alternative 3	<input type="checkbox"/> Option 9																											
<input type="checkbox"/> Class B, Alternative 4	<input type="checkbox"/> Option 10																											
<input type="checkbox"/> Domestic septage, pH adjustment	<input type="checkbox"/> Option 11																											

EPA Identification Number	NPDES Permit Number CA8000344	Facility Name Big Bear City RTP	Form Approved 03/05/19 OMB No. 2040-0004												
Generation of Sewage Sludge or Preparation of a Material Derived from Sewage Sludge Continued	2.23	<p>Which treatment process(es) are used at the receiving facility to reduce pathogens in sewage sludge or reduce the vector attraction properties of sewage sludge from your facility? (Check all that apply.)</p> <table border="0" style="width: 100%;"> <tr> <td><input type="checkbox"/> Preliminary operations (e.g., sludge grinding and dewatering)</td> <td><input type="checkbox"/> Thickening (concentration)</td> </tr> <tr> <td><input type="checkbox"/> Stabilization</td> <td><input type="checkbox"/> Anaerobic digestion</td> </tr> <tr> <td><input checked="" type="checkbox"/> Composting</td> <td><input type="checkbox"/> Conditioning</td> </tr> <tr> <td><input type="checkbox"/> Disinfection (e.g., beta ray irradiation, gamma ray irradiation, pasteurization)</td> <td><input type="checkbox"/> Dewatering (e.g., centrifugation, sludge drying beds, sludge lagoons)</td> </tr> <tr> <td><input type="checkbox"/> Heat drying</td> <td><input type="checkbox"/> Thermal reduction</td> </tr> <tr> <td><input type="checkbox"/> Methane or biogas capture and recovery</td> <td><input type="checkbox"/> Other (specify) _____</td> </tr> </table>		<input type="checkbox"/> Preliminary operations (e.g., sludge grinding and dewatering)	<input type="checkbox"/> Thickening (concentration)	<input type="checkbox"/> Stabilization	<input type="checkbox"/> Anaerobic digestion	<input checked="" type="checkbox"/> Composting	<input type="checkbox"/> Conditioning	<input type="checkbox"/> Disinfection (e.g., beta ray irradiation, gamma ray irradiation, pasteurization)	<input type="checkbox"/> Dewatering (e.g., centrifugation, sludge drying beds, sludge lagoons)	<input type="checkbox"/> Heat drying	<input type="checkbox"/> Thermal reduction	<input type="checkbox"/> Methane or biogas capture and recovery	<input type="checkbox"/> Other (specify) _____
	<input type="checkbox"/> Preliminary operations (e.g., sludge grinding and dewatering)	<input type="checkbox"/> Thickening (concentration)													
	<input type="checkbox"/> Stabilization	<input type="checkbox"/> Anaerobic digestion													
	<input checked="" type="checkbox"/> Composting	<input type="checkbox"/> Conditioning													
	<input type="checkbox"/> Disinfection (e.g., beta ray irradiation, gamma ray irradiation, pasteurization)	<input type="checkbox"/> Dewatering (e.g., centrifugation, sludge drying beds, sludge lagoons)													
	<input type="checkbox"/> Heat drying	<input type="checkbox"/> Thermal reduction													
	<input type="checkbox"/> Methane or biogas capture and recovery	<input type="checkbox"/> Other (specify) _____													
	2.24	<p>Attach a copy of any information you provide the receiving facility to comply with the "notice and necessary information" requirement of 40 CFR 503.12(g).</p> <input type="checkbox"/> Check here to indicate that you have attached material.													
	2.25	<p>Does the receiving facility place sewage sludge from your facility in a bag or other container for sale or give-away for application to the land?</p> <input type="checkbox"/> Yes <input checked="" type="checkbox"/> No → SKIP to Item 2.32 (Part 2, Section 2) below.													
	2.26	<p>Attach a copy of all labels or notices that accompany the product being sold or given away.</p> <input type="checkbox"/> Check here to indicate that you have attached material.													
<input checked="" type="checkbox"/> Check here once you have completed Items 2.17 to 2.26 (Part 2, Section 2), then → SKIP to Item 2.32 (Part 2, Section 2) below.															

IV. Location Maps

1. Facility and Service Area Topographic Map
2. Facility and Discharge Points Topographic Map
3. Facility Layout Map
4. Nursery Products Biosolids Receiving Facility Map

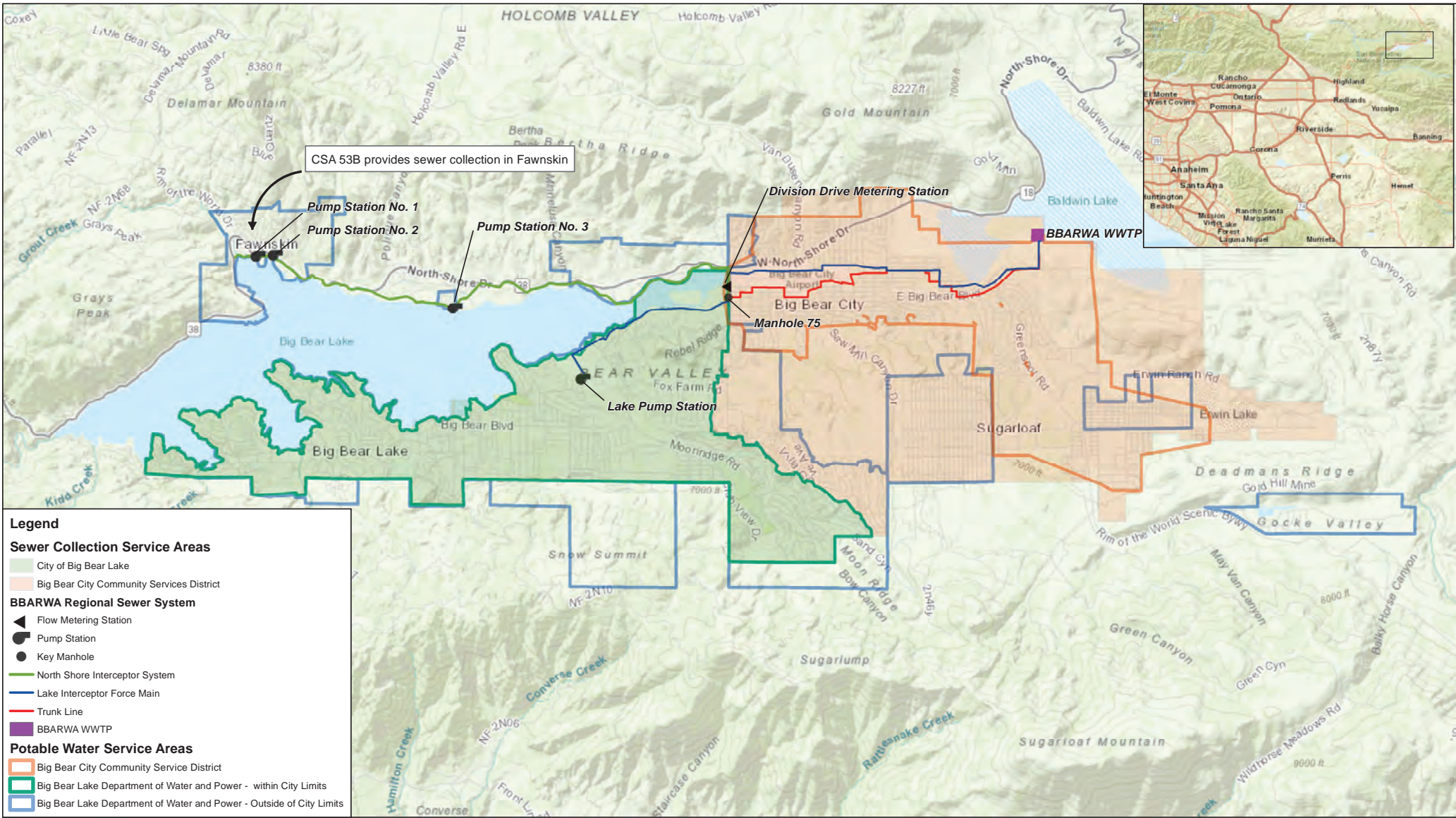

Legend

Sewer Collection Service Areas

- City of Big Bear Lake
- Big Bear City Community Services District

BBARWA Regional Sewer System

- Flow Metering Station
- Pump Station
- Key Manhole
- North Shore Interceptor System
- Lake Interceptor Force Main
- Trunk Line
- BBARWA WWTP

Potable Water Service Areas

- Big Bear City Community Service District
- Big Bear Lake Department of Water and Power - within City Limits
- Big Bear Lake Department of Water and Power - Outside of City Limits

Big Bear Area Regional Wastewater Agency
 Sewer Service Area and Big Bear Valley
 Potable Water Service Areas
 1/28/2022

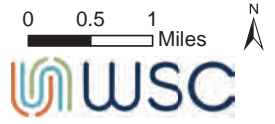

Map created on 1/14/2022

Legend



Lake Discharge Proposed Location



Shay Pond Discharge Location

Facilities



Pumps



WWTP

Pipelines from WWTP to Lake

 Proposed Pipelines

 Existing Pipeline

Big Bear Lake and Stanfield Marsh

 Stanfield Marsh

 Big Bear Lake Boundary

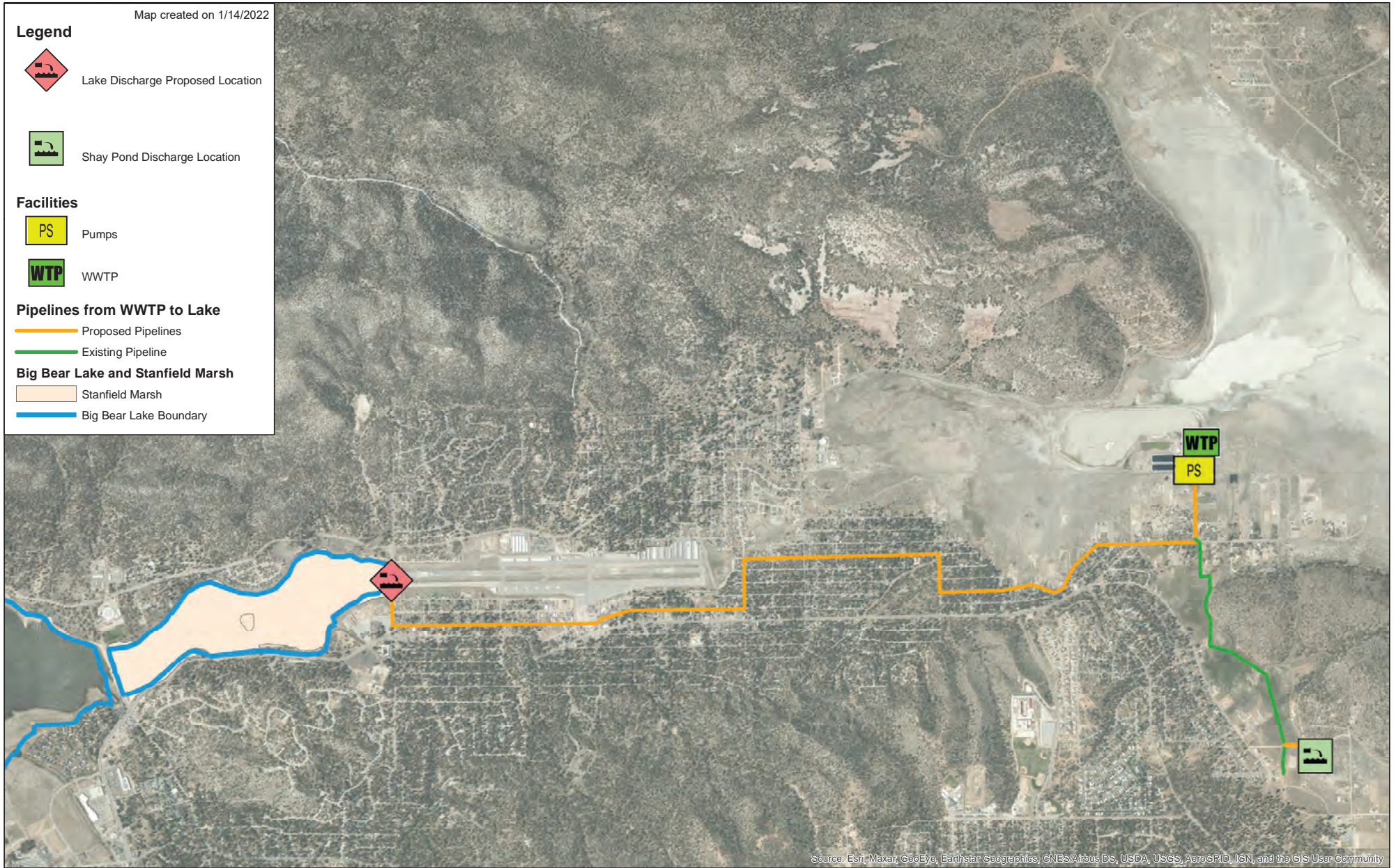



Existing Facility Layout (1/28/2022)

Note, this map does not show additional areas designated for solar power facilities near the Administration Building, as these areas do not impact site planning for treatment process upgrades.

Map of Nursery Products Hawes Composting Facility

YOUR PARTNER FOR A CLEANER,
GREENER WORLD

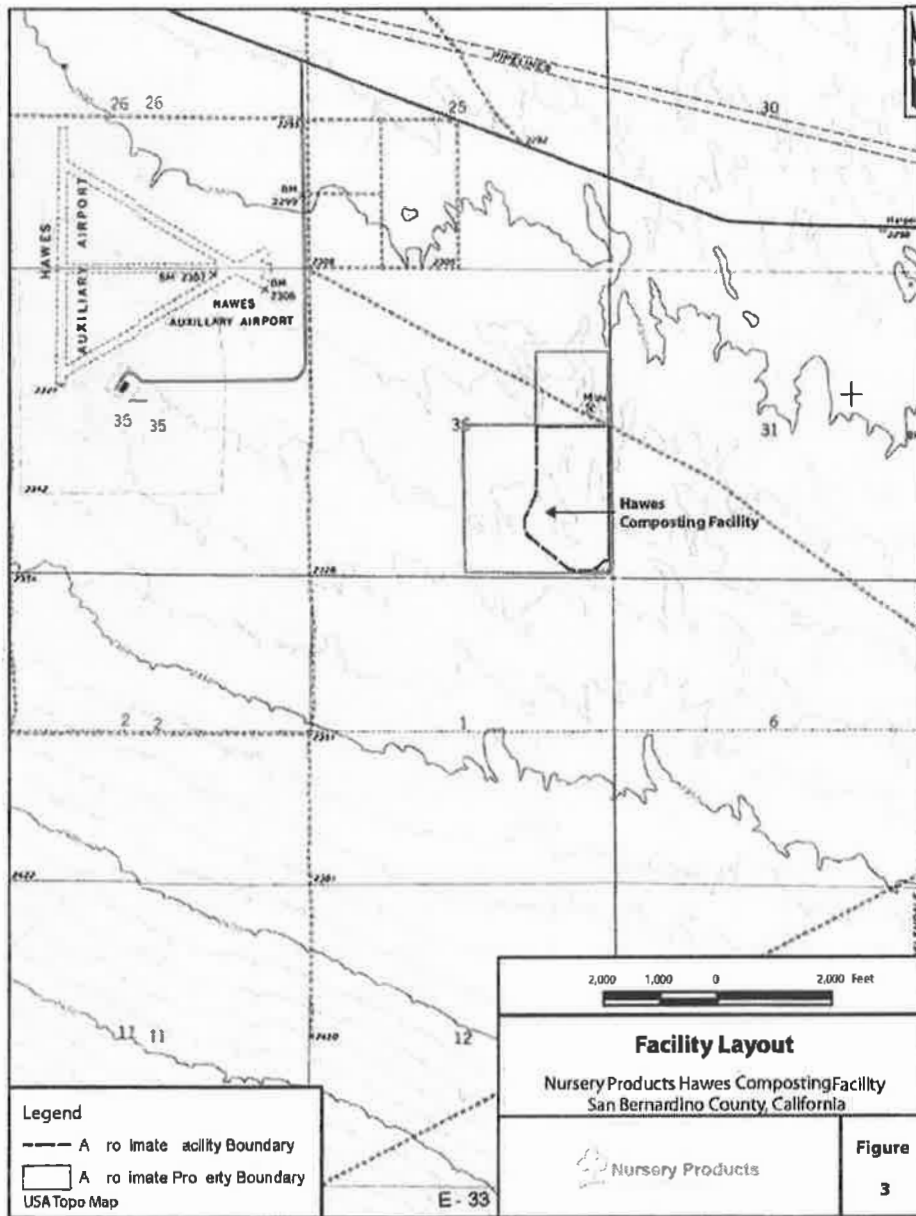

V. Treatment Processes

1. Treatment Process Narrative
2. Existing Treatment Process Schematic
3. Future Upgraded Treatment Process Schematic
4. Arizona Soils Biosolids Receiving Facility Schematic

Treatment Process Narrative

Existing Treatment Process

Big Bear Area Regional Wastewater Agency (BBARWA) is a joint powers authority consisting of Big Bear City Community Services District, City of Big Bear Lake, and San Bernardino County Service Area 53-B¹. BBARWA owns and operates a regional Wastewater Treatment Plant (WWTP). The WWTP treats commercial and domestic wastewater from these three collection systems.

The existing WWTP has a design capacity of 4.89 million gallons per day (MGD). The existing treatment process includes the following:

- Preliminary treatment consisting of a mechanical coarse screen and an aerated grit chamber;
- Secondary treatment consisting of extended aeration oxidation ditches and secondary clarifiers; and
- Solids handling through a dewatering belt filter press.

Treated effluent is temporarily stored on-site prior to discharge to Lucerne Valley. Dewatered solids are hauled off-site.

Future Upgraded Treatment Process

As part of the Replenish Big Bear Program, proposed upgrades to the BBARWA WWTP include:

- Biological nutrient removal added to the existing oxidation ditches;
- Tertiary filtration and nutrient removal via denitrification filters, ultrafiltration (UF), and reverse osmosis (RO) membrane filtration;
- Brine pellet reactor for brine minimization; and
- Ultraviolet (UV) disinfection processes.

The new facilities would be designed for a treatment capacity of 2.2 MGD, with operational capabilities to divert a portion of the denitrification filter effluent directly to ultraviolet disinfection depending on effluent water quality targets and treatment performance. However, it is anticipated that 100% of the water discharged will be treated with RO and UV disinfection. The anticipated completion date is mid-2026.

Solids generated through the brine pellet reactor would be disposed off-site and the liquid stream reject from the brine pellet reactor process would be conveyed to brine evaporation ponds on-site at the BBARWA WWTP for drying and disposal. Treated effluent would be discharged to Shay Pond and Stanfield Marsh, which flows into Big Bear Lake. BBARWA is planning to maintain its current discharge location in Lucerne Valley, where undisinfected secondary effluent is currently used to irrigate fodder crops used for livestock feed. The dewatered solids would continue to be hauled off-site.

¹ BBARWA owns and maintains the trunk lines and force main pump station to convey flows from CSA 53B to the WWTP, but CSA 53B maintains their own collection system.

A detailed summary of the treatment process upgrades is shown in **Table 1**.

Table 1. Summary of Treatment Process Upgrades

Treatment Mode	Processes
Biological Nutrient Removal	Nitrification-Denitrification: Retrofit existing oxidation ditches to a Modified Ludzack-Ettinger (MLE) configuration with turbo blowers and diffused aeration for nitrogen removal.
Tertiary Filtration & Nutrient Removal	Denitrification Filter: Construct denitrification filters for nitrogen and phosphorus removal. Chemical provisions for supplemental carbon and chemical precipitant addition will be provided for denitrification and phosphorus removal, respectively.
Membrane Filtration	Ultrafiltration and Reverse Osmosis: Construct skid-mounted pressurized UF membranes and RO membrane facilities capable of high recovery, high TDS removal, and removal of residual nutrients. Chemical provisions for antiscalant, pH adjustment, and remineralization chemicals will be provided. Brine from the RO system will be conveyed to the Pellet Reactor for brine minimization.
Disinfection	UV Disinfection: Construct closed vessel UV disinfection unit process for disinfection of denitrification filter effluent or RO permeate water. UV design criteria such as UV transmittance and UV dose are dependent on the quality of the feed water.
Brine Minimization	Pellet Reactor: Construct a skid-mounted pellet reactor system which provides brine minimization through additional RO membrane filtration and precipitation of partially soluble salts through a fluidized bed reactor.

The projected effluent quality of the proposed discharge is presented in **Table 2** for the constituents of interest.

Table 2. Summary of Projected Effluent Quality

Constituent	Projected Effluent Quality	Units
Ammonia as N	0.05	mg/L
Boron	0.11	mg/L
Chloride	0.60	mg/L
Fluoride	<0.026 ^[a]	mg/L
Hardness, Total (as CaCO ₃)	3.20	mg/L
MBAS	0.0014	mg/L
Sodium	1.9	mg/L
Sulfate	0.20	mg/L
Total Dissolved Solids (TDS)	50	mg/L
Total Inorganic Nitrogen (TIN)	0.10	mg/L-N
Total Nitrogen (TN)	0.60	mg/L-N

Constituent	Projected Effluent Quality	Units
Chlorophyll-a ^[b]	N/A	µg/L
Total Phosphorus (TP)	0.03	mg/L-P
Chlordane	<0.17 ^[a]	µg/L
4,4'-DDT	<0.0052 ^[a]	µg/L
PCBs	<2.5 ^[a]	µg/L
Cadmium	<0.11 ^[a]	µg/L
Copper	0.07	µg/L
Lead	0.01	µg/L
Mercury	<0.05 ^[a]	ng/L
Aluminum	1.3	µg/L
Specific Conductance	18	µmhos/cm

[a] The projected effluent quality is anticipated to be below the detection limit.

[b] Chlorophyll a is not a constituent that will be discharged by the BBARWA WWTP.

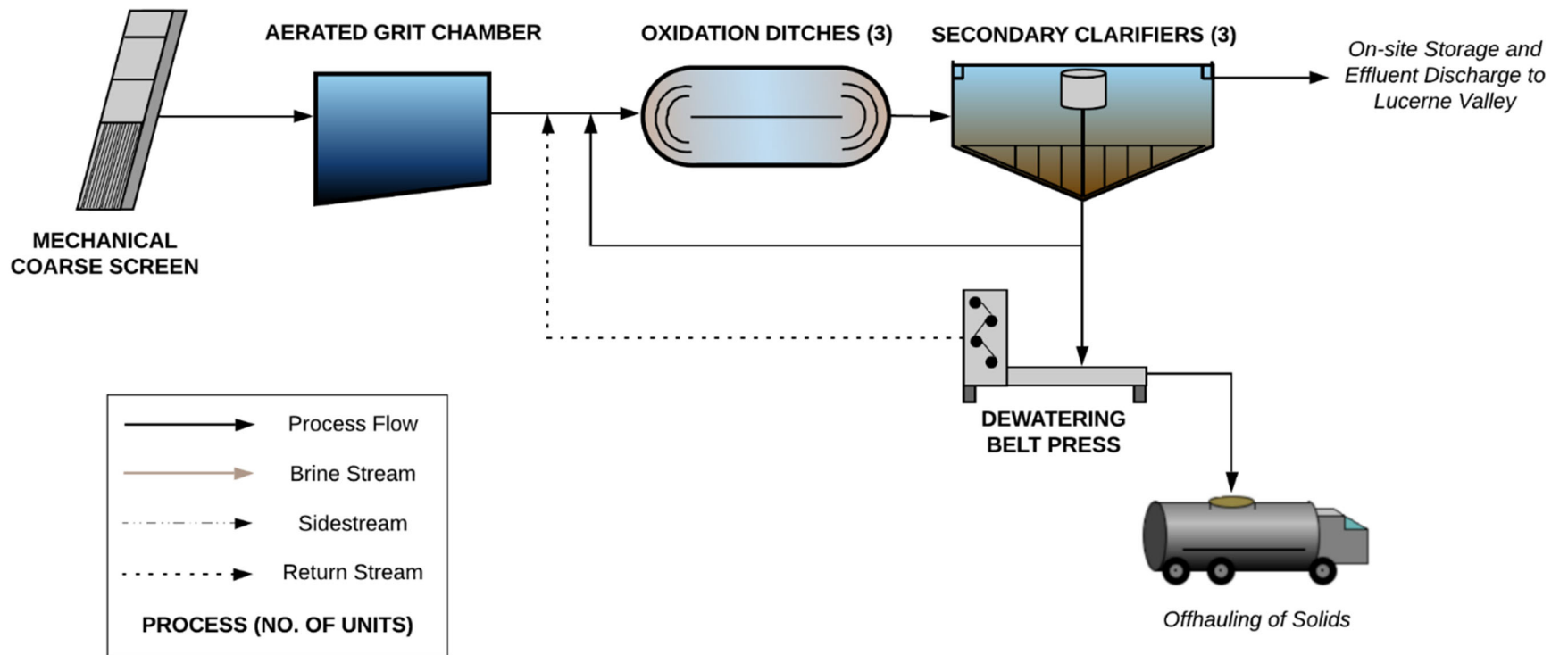

Figure 1. Existing Treatment Process Schematic

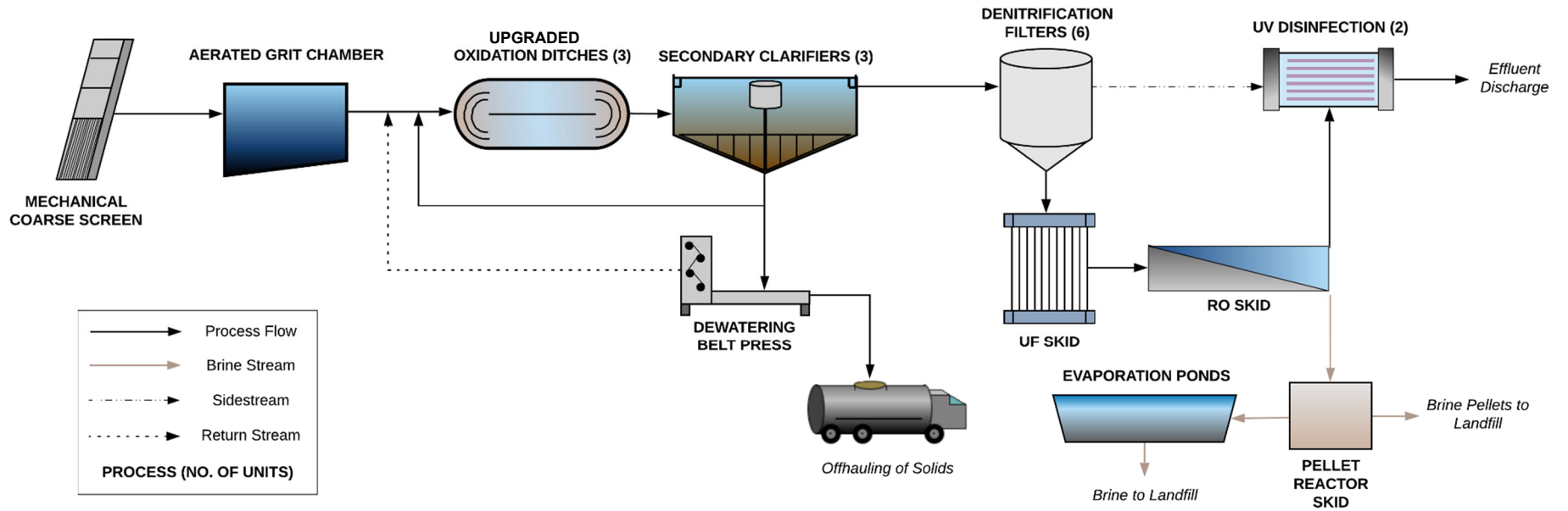
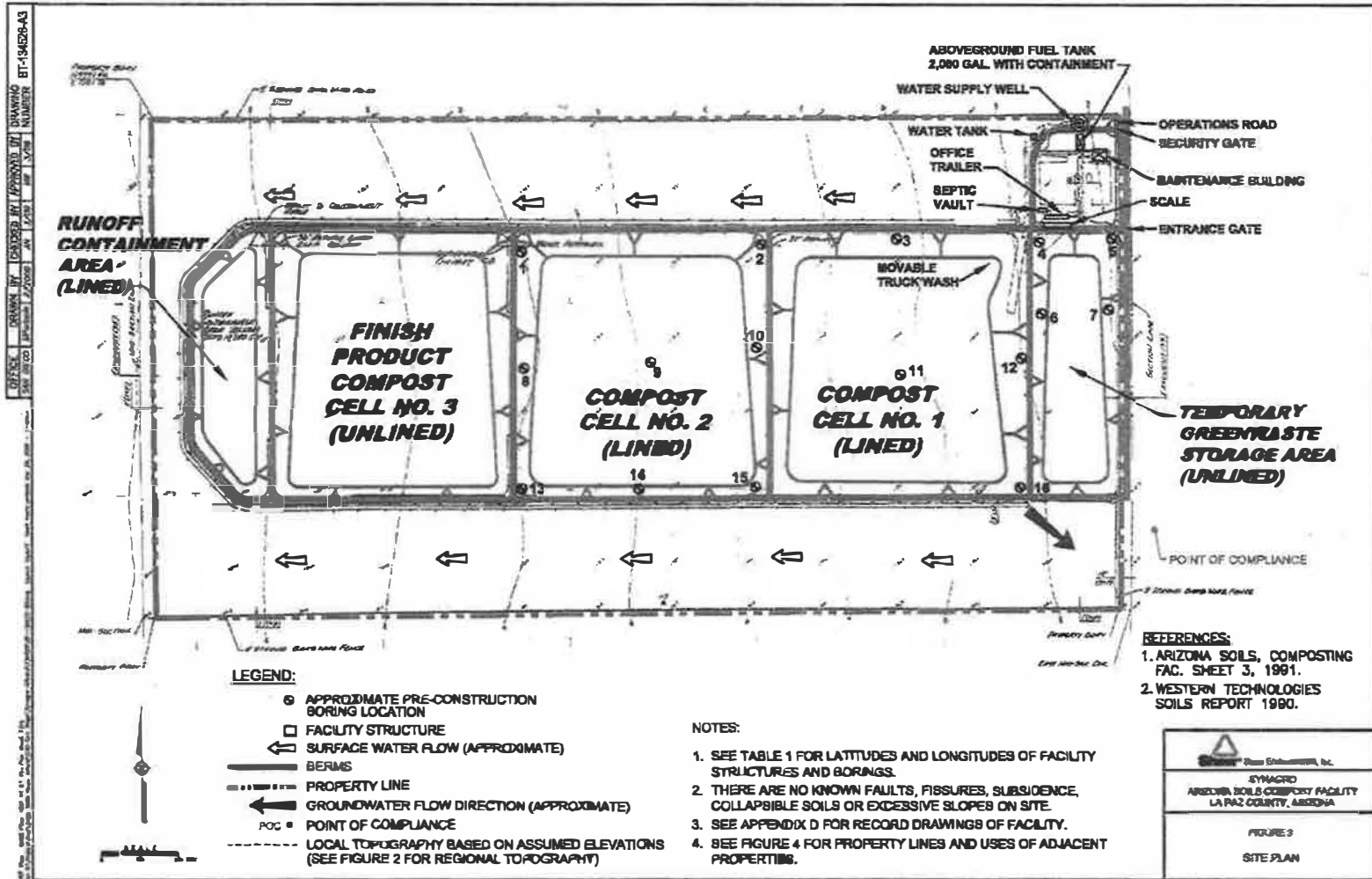

Figure 2. Future Upgraded Treatment Process Schematic

Schematic of Arizona Soils Composting Facility



Professional

DRAWING BY: [unreadable] DATE: [unreadable] SHEET NUMBER: BT-14829-A3

VI. Supplemental Information

Attachment A. Secondary Effluent and Receiving Water
Characterization Data

Attachment B. Big Bear Lake Nutrient Total Maximum Daily Load
Analysis for Total Phosphorus Offset Program

Attachment C. Antidegradation Analysis for Proposed Discharges
to Big Bear Lake and Shay Pond

Attachment A.

Secondary Effluent and Receiving Water
Characterization Data

Secondary Effluent and Receiving Water Characterization Data

Location	PTP	Analyte	Qualifier	Result	Units	RL	MDL	Analytical Method	Sample Date	Analysis Date
Secondary Effluent	1	Antimony	<	ND	µg/L	6	0.14	EPA 200.8	12/1/2016	
Secondary Effluent	1	Antimony	<	ND	µg/L	6	0.14	EPA 200.8	11/29/2017	
Secondary Effluent	1	Antimony	<	ND	µg/L	6	0.14	EPA 200.8	12/5/2018	
Secondary Effluent	1	Antimony	<	ND	µg/L	6	0.14	EPA 200.8	12/12/2018	
Secondary Effluent	1	Antimony	=	0.23	µg/L	6	0.14	EPA 200.8	11/20/2019	
Secondary Effluent	1	Antimony	<	ND	µg/L	6	0.14	EPA 200.8	12/18/2019	
Secondary Effluent	1	Antimony	<	ND	µg/L	6	0.14	EPA 200.8	12/2/2020	
Secondary Effluent	1	Antimony	<	ND	µg/L	6	0.14	EPA 200.8	11/18/2021	11/24/2021
Secondary Effluent	2	Arsenic	<	ND	µg/L	2	0.4	EPA 200.8	12/1/2016	
Secondary Effluent	2	Arsenic	<	ND	µg/L	2	0.4	EPA 200.8	11/29/2017	
Secondary Effluent	2	Arsenic	<	ND	µg/L	2	0.4	EPA 200.8	12/5/2018	
Secondary Effluent	2	Arsenic	<	ND	µg/L	2	0.4	EPA 200.8	12/12/2018	
Secondary Effluent	2	Arsenic	=	0.73	µg/L	2	0.4	EPA 200.8	11/20/2019	
Secondary Effluent	2	Arsenic	<	ND	µg/L	2	0.4	EPA 200.8	12/18/2019	
Secondary Effluent	2	Arsenic	<	ND	µg/L	2	0.4	EPA 200.8	12/2/2020	
Secondary Effluent	2	Arsenic	<	ND	µg/L	2	0.4	EPA 200.8	11/18/2021	11/24/2021
Secondary Effluent	3	Beryllium	<	ND	µg/L	1	0.2	EPA 200.8	12/1/2016	
Secondary Effluent	3	Beryllium	<	ND	µg/L	1	0.2	EPA 200.8	11/29/2017	
Secondary Effluent	3	Beryllium	<	ND	µg/L	1	0.2	EPA 200.8	12/5/2018	
Secondary Effluent	3	Beryllium	<	ND	µg/L	1	0.2	EPA 200.8	12/12/2018	
Secondary Effluent	3	Beryllium	<	ND	µg/L	1	0.2	EPA 200.8	11/20/2019	
Secondary Effluent	3	Beryllium	<	ND	µg/L	1	0.2	EPA 200.8	12/18/2019	
Secondary Effluent	3	Beryllium	<	ND	µg/L	1	0.2	EPA 200.8	12/2/2020	
Secondary Effluent	3	Beryllium	<	ND	µg/L	1	0.2	EPA 200.8	11/18/2021	11/24/2021
Secondary Effluent	4	Cadmium	<	ND	µg/L	1	0.11	EPA 200.8	12/1/2016	
Secondary Effluent	4	Cadmium	<	ND	µg/L	1	0.11	EPA 200.8	11/29/2017	
Secondary Effluent	4	Cadmium	<	ND	µg/L	1	0.11	EPA 200.8	12/5/2018	
Secondary Effluent	4	Cadmium	<	ND	µg/L	1	0.11	EPA 200.8	12/12/2018	
Secondary Effluent	4	Cadmium	<	ND	µg/L	1	0.11	EPA 200.8	11/20/2019	
Secondary Effluent	4	Cadmium	<	ND	µg/L	1	0.11	EPA 200.8	12/18/2019	
Secondary Effluent	4	Cadmium	<	ND	µg/L	1	0.11	EPA 200.8	12/2/2020	
Secondary Effluent	4	Cadmium	<	ND	µg/L	1	0.11	EPA 200.8	11/18/2021	11/24/2021
Secondary Effluent	5a	Chromium (III)	<	ND	µg/L			Calculated	12/1/2016	
Secondary Effluent	5a	Chromium (III)	=	2.6	µg/L			Calculated	11/29/2017	
Secondary Effluent	5a	Chromium (III)	=	0.58	µg/L			Calculated	12/5/2018	
Secondary Effluent	5a	Chromium (III)	<	ND	µg/L	10		Calculated	12/18/2019	
Secondary Effluent	5a	Chromium (III)	<	ND	µg/L	10		Calculated	12/2/2020	
Secondary Effluent	5a	Chromium (III)	J	0.72	µg/L			Calculated	11/18/2021	11/24/2021

Secondary Effluent and Receiving Water Characterization Data

Location	PTP	Analyte	Qualifier	Result	Units	RL	MDL	Analytical Method	Sample Date	Analysis Date
Secondary Effluent	5b	Chromium (VI)	<	ND	µg/L	1	0.14	EPA 218.6	12/1/2016	
Secondary Effluent	5b	Chromium (VI)	<	ND	µg/L	1	0.14	EPA 218.6	11/29/2017	
Secondary Effluent	5b	Chromium (VI)	<	ND	µg/L	1	0.14	EPA 218.6	12/5/2018	
Secondary Effluent	5b	Chromium (VI)	<	ND	µg/L	1	0.14	EPA 218.6	12/12/2018	
Secondary Effluent	5b	Chromium (VI)	<	ND	µg/L	1	0.14	EPA 218.6	11/20/2019	
Secondary Effluent	5b	Chromium (VI)	<	ND	µg/L	1	0.14	EPA 218.6	12/18/2019	
Secondary Effluent	5b	Chromium (VI)	<	ND	µg/L	1	0.14	EPA 218.6	12/2/2020	
Secondary Effluent	5b	Chromium (VI)	<	ND	µg/L	1	0.14	EPA 218.6	11/18/2021	11/24/2021
Secondary Effluent	5	Chromium (Total Cr)	=	0.89	µg/L	10	0.21	EPA 200.8	11/20/2019	
Secondary Effluent	5	Chromium (Total Cr)	J	0.72	µg/L	10	0.21	EPA 200.8	11/18/2021	11/24/2021
Secondary Effluent	6	Copper	<	ND	µg/L	50	6.5	EPA 200.7	12/1/2016	
Secondary Effluent	6	Copper	<	ND	µg/L	50	6.5	EPA 200.7	11/29/2017	
Secondary Effluent	6	Copper	<	ND	µg/L	50	6.5	EPA 200.7	12/5/2018	
Secondary Effluent	6	Copper	<	ND	µg/L	50	6.5	EPA 200.7	12/12/2018	
Secondary Effluent	6	Copper	<	ND	µg/L	50	6.5	EPA 200.7	11/20/2019	
Secondary Effluent	6	Copper	<	ND	µg/L	50	6.5	EPA 200.7	12/18/2019	
Secondary Effluent	6	Copper	<	ND	µg/L	50	6.5	EPA 200.7	12/2/2020	
Secondary Effluent	6	Copper	J	14	µg/L	50	6.5	EPA 200.7	11/18/2021	11/23/2021
Secondary Effluent	7	Lead	<	ND	µg/L	5	0.51	EPA 200.8	12/1/2016	
Secondary Effluent	7	Lead	<	ND	µg/L	5	0.51	EPA 200.8	11/29/2017	
Secondary Effluent	7	Lead	<	ND	µg/L	5	0.51	EPA 200.8	12/5/2018	
Secondary Effluent	7	Lead	<	ND	µg/L	5	0.51	EPA 200.8	12/12/2018	
Secondary Effluent	7	Lead	=	0.76	µg/L	5	0.51	EPA 200.8	11/20/2019	
Secondary Effluent	7	Lead	<	ND	µg/L	5	0.51	EPA 200.8	12/18/2019	
Secondary Effluent	7	Lead	<	ND	µg/L	5	0.51	EPA 200.8	12/2/2020	
Secondary Effluent	7	Lead	J	1.8	µg/L	5	0.51	EPA 200.8	11/18/2021	11/24/2021
Secondary Effluent	8	Mercury, Total	<	ND	µg/L	0.2	0.15	EPA 245.1	12/1/2016	
Secondary Effluent	8	Mercury, Total	<	ND	µg/L	0.2	0.15	EPA 245.1	11/29/2017	
Secondary Effluent	8	Mercury, Total	<	ND	µg/L	0.2	0.05	EPA 245.1	12/5/2018	
Secondary Effluent	8	Mercury, Total	<	ND	µg/L	0.2	0.15	EPA 245.1	11/20/2019	
Secondary Effluent	8	Mercury, Total	<	ND	µg/L	0.2	0.15	EPA 245.1	12/18/2019	
Secondary Effluent	8	Mercury, Total	=	0.00076	µg/L	5E-04		EPA 1631E	6/18/2020	6/24/2020
Secondary Effluent	8	Mercury, Total	<	ND	µg/L	0.2	0.15	EPA 245.1	12/2/2020	
Secondary Effluent	8	Mercury, Total	<	ND	µg/L	1	0.15	EPA 245.1	11/18/2021	12/13/2021
Secondary Effluent		Mercury, Dissolved	<	ND	µg/L	5E-04		EPA 1631E filtrate	6/18/2020	6/24/2020
Secondary Effluent		Methylmercury	=	0.18	ng/L	0.05		EPA 1630	6/18/2020	6/25/2020
Secondary Effluent		Methylmercury, Dissolved	=	0.13	ng/L	0.05		EPA 1630 filtrate	6/18/2020	6/25/2020
Secondary Effluent	9	Nickel	<	ND	µg/L	10	0.52	EPA 200.8	12/1/2016	

Secondary Effluent and Receiving Water Characterization Data

Location	PTP	Analyte	Qualifier	Result	Units	RL	MDL	Analytical Method	Sample Date	Analysis Date
Secondary Effluent	9	Nickel	<	ND	µg/L	10	0.52	EPA 200.8	11/29/2017	
Secondary Effluent	9	Nickel	<	ND	µg/L	10	0.52	EPA 200.8	12/5/2018	
Secondary Effluent	9	Nickel	<	ND	µg/L	10	0.52	EPA 200.8	12/12/2018	
Secondary Effluent	9	Nickel	=	6.3	µg/L	10	0.52	EPA 200.8	11/20/2019	
Secondary Effluent	9	Nickel	<	ND	µg/L	10	0.52	EPA 200.8	12/18/2019	
Secondary Effluent	9	Nickel	<	ND	µg/L	10	0.52	EPA 200.8	12/2/2020	
Secondary Effluent	9	Nickel	J	0.96	µg/L	10	0.52	EPA 200.8	11/18/2021	11/24/2021
Secondary Effluent	10	Selenium	<	ND	µg/L	5	0.95	EPA 200.8	12/1/2016	
Secondary Effluent	10	Selenium	<	ND	µg/L	5	0.95	EPA 200.8	11/29/2017	
Secondary Effluent	10	Selenium	<	ND	µg/L	5	0.95	EPA 200.8	12/5/2018	
Secondary Effluent	10	Selenium	<	ND	µg/L	5	0.95	EPA 200.8	12/12/2018	
Secondary Effluent	10	Selenium	=	2.1	µg/L	5	0.95	EPA 200.8	11/20/2019	
Secondary Effluent	10	Selenium	<	ND	µg/L	5	0.95	EPA 200.8	12/18/2019	
Secondary Effluent	10	Selenium	<	ND	µg/L	5	0.95	EPA 200.8	12/2/2020	
Secondary Effluent	10	Selenium	J	2.7	µg/L	5	0.95	EPA 200.8	11/18/2021	11/24/2021
Secondary Effluent	11	Silver	<	ND	µg/L	10	0.3	EPA 200.8	12/1/2016	
Secondary Effluent	11	Silver	<	ND	µg/L	10	0.3	EPA 200.8	11/29/2017	
Secondary Effluent	11	Silver	<	ND	µg/L	10	0.3	EPA 200.8	12/5/2018	
Secondary Effluent	11	Silver	<	ND	µg/L	10	0.3	EPA 200.8	12/12/2018	
Secondary Effluent	11	Silver	=	0.3	µg/L	10	0.3	EPA 200.8	11/20/2019	
Secondary Effluent	11	Silver	<	ND	µg/L	10	0.3	EPA 200.8	12/18/2019	
Secondary Effluent	11	Silver	<	ND	µg/L	10	0.3	EPA 200.8	12/2/2020	
Secondary Effluent	11	Silver	<	ND	µg/L	10	0.3	EPA 200.8	11/18/2021	11/24/2021
Secondary Effluent	12	Thallium	<	ND	µg/L	1	0.18	EPA 200.8	12/1/2016	
Secondary Effluent	12	Thallium	<	ND	µg/L	1	0.18	EPA 200.8	11/29/2017	
Secondary Effluent	12	Thallium	<	ND	µg/L	1	0.18	EPA 200.8	12/5/2018	
Secondary Effluent	12	Thallium	<	ND	µg/L	1	0.18	EPA 200.8	12/12/2018	
Secondary Effluent	12	Thallium	<	ND	µg/L	1	0.18	EPA 200.8	11/20/2019	
Secondary Effluent	12	Thallium	<	ND	µg/L	1	0.18	EPA 200.8	12/18/2019	
Secondary Effluent	12	Thallium	<	ND	µg/L	1	0.18	EPA 200.8	12/2/2020	
Secondary Effluent	12	Thallium	<	ND	µg/L	1	0.18	EPA 200.8	11/18/2021	11/24/2021
Secondary Effluent	13	Zinc	=	63	µg/L	50	15	EPA 200.7	12/1/2016	
Secondary Effluent	13	Zinc	=	50	µg/L	50	15	EPA 200.7	11/29/2017	
Secondary Effluent	13	Zinc	<	ND	µg/L	50	15	EPA 200.7	12/5/2018	
Secondary Effluent	13	Zinc	<	ND	µg/L	50	15	EPA 200.7	12/12/2018	
Secondary Effluent	13	Zinc	=	120	µg/L	50	15	EPA 200.7	11/20/2019	
Secondary Effluent	13	Zinc	=	110	µg/L	50	15	EPA 200.7	12/18/2019	
Secondary Effluent	13	Zinc	=	51	µg/L	50	15	EPA 200.7	12/2/2020	

Secondary Effluent and Receiving Water Characterization Data

Location	PTP	Analyte	Qualifier	Result	Units	RL	MDL	Analytical Method	Sample Date	Analysis Date
Secondary Effluent	13	Zinc	=	87	µg/L	50	15	EPA 200.7	11/18/2021	11/23/2021
Secondary Effluent	14	Cyanide (total)	=	2.7	µg/L	5	1.2	SM4500-CN E	11/20/2019	
Secondary Effluent	14	Cyanide (total)	J	2	µg/L	5	1.2	SM 4500CN-F	11/18/2021	12/13/2021
Secondary Effluent	15	Asbestos	=	2	MFL	0.5	0.5	EPA 100.2	11/18/2021	12/13/2021
Secondary Effluent	16	2,3,7,8-TCDD	<	ND	pg/L	5	5	EPA 1613B	11/18/2021	12/13/2021
Secondary Effluent	17	Acrolein	<	ND	µg/L	5		EPA 624	12/1/2016	
Secondary Effluent	17	Acrolein	<	ND	µg/L	5		EPA 624	11/29/2017	
Secondary Effluent	17	Acrolein	<	ND	µg/L	5		EPA 624	12/5/2018	
Secondary Effluent	17	Acrolein	<	ND	µg/L	20		EPA 624	12/18/2019	
Secondary Effluent	17	Acrolein	<	ND	µg/L	2		EPA 624	12/2/2020	
Secondary Effluent	17	Acrolein	<	ND	µg/L	2	1.2	EPA 624.1	11/18/2021	12/13/2021
Secondary Effluent	18	Acrylonitrile	<	ND	µg/L	5		EPA 624	12/1/2016	
Secondary Effluent	18	Acrylonitrile	<	ND	µg/L	5		EPA 624	11/29/2017	
Secondary Effluent	18	Acrylonitrile	<	ND	µg/L	5		EPA 624	12/5/2018	
Secondary Effluent	18	Acrylonitrile	<	ND	µg/L	20		EPA 624	12/18/2019	
Secondary Effluent	18	Acrylonitrile	<	ND	µg/L	2		EPA 624	12/2/2020	
Secondary Effluent	18	Acrylonitrile	<	ND	µg/L	2	0.6	EPA 624.1	11/18/2021	12/13/2021
Secondary Effluent	19	Benzene	<	ND	µg/L	1		EPA 624	12/1/2016	
Secondary Effluent	19	Benzene	<	ND	µg/L	1		EPA 624	11/29/2017	
Secondary Effluent	19	Benzene	<	ND	µg/L	1		EPA 624	12/5/2018	
Secondary Effluent	19	Benzene	<	ND	µg/L	5		EPA 624	12/18/2019	
Secondary Effluent	19	Benzene	<	ND	µg/L	0.5		EPA 624	12/2/2020	
Secondary Effluent	19	Benzene	<	ND	µg/L	0.5	0.096	EPA 624.1	11/18/2021	12/13/2021
Secondary Effluent	20	Bromoform	<	ND	µg/L	1		EPA 624	12/1/2016	
Secondary Effluent	20	Bromoform	<	ND	µg/L	1		EPA 624	11/29/2017	
Secondary Effluent	20	Bromoform	<	ND	µg/L	1		EPA 624	12/5/2018	
Secondary Effluent	20	Bromoform	<	ND	µg/L	5		EPA 624	12/18/2019	
Secondary Effluent	20	Bromoform	<	ND	µg/L	0.5		EPA 624	12/2/2020	
Secondary Effluent	20	Bromoform	<	ND	µg/L	0.5	0.072	EPA 624.1	11/18/2021	12/13/2021
Secondary Effluent	21	Carbon Tetrachloride	<	ND	µg/L	1		EPA 624	12/1/2016	
Secondary Effluent	21	Carbon Tetrachloride	<	ND	µg/L	1		EPA 624	11/29/2017	
Secondary Effluent	21	Carbon Tetrachloride	<	ND	µg/L	1		EPA 624	12/5/2018	
Secondary Effluent	21	Carbon Tetrachloride	<	ND	µg/L	5		EPA 624	12/18/2019	
Secondary Effluent	21	Carbon Tetrachloride	<	ND	µg/L	0.5		EPA 624	12/2/2020	
Secondary Effluent	21	Carbon Tetrachloride	<	ND	µg/L	0.5	0.1	EPA 624.1	11/18/2021	12/13/2021
Secondary Effluent	22	Chlorobenzene	<	ND	µg/L	1		EPA 624	12/1/2016	
Secondary Effluent	22	Chlorobenzene	<	ND	µg/L	1		EPA 624	11/29/2017	
Secondary Effluent	22	Chlorobenzene	<	ND	µg/L	1		EPA 624	12/5/2018	

Secondary Effluent and Receiving Water Characterization Data

Location	PTP	Analyte	Qualifier	Result	Units	RL	MDL	Analytical Method	Sample Date	Analysis Date
Secondary Effluent	22	Chlorobenzene	<	ND	µg/L	5		EPA 624	12/18/2019	
Secondary Effluent	22	Chlorobenzene	<	ND	µg/L	0.5		EPA 624	12/2/2020	
Secondary Effluent	22	Chlorobenzene	<	ND	µg/L	0.5	0.088	EPA 624.1	11/18/2021	12/13/2021
Secondary Effluent	23	Chlorodibromomethane	<	ND	µg/L	1		EPA 624	12/1/2016	
Secondary Effluent	23	Chlorodibromomethane	<	ND	µg/L	1		EPA 624	11/29/2017	
Secondary Effluent	23	Chlorodibromomethane	<	ND	µg/L	1		EPA 624	12/5/2018	
Secondary Effluent	23	Chlorodibromomethane	<	ND	µg/L	5		EPA 624	12/18/2019	
Secondary Effluent	23	Chlorodibromomethane	<	ND	µg/L	0.5		EPA 624	12/2/2020	
Secondary Effluent	23	Chlorodibromomethane	<	ND	µg/L	0.5	0.052	EPA 624.1	11/18/2021	12/13/2021
Secondary Effluent	24	Chloroethane	<	ND	µg/L	1		EPA 624	12/1/2016	
Secondary Effluent	24	Chloroethane	<	ND	µg/L	1		EPA 624	11/29/2017	
Secondary Effluent	24	Chloroethane	<	ND	µg/L	1		EPA 624	12/5/2018	
Secondary Effluent	24	Chloroethane	<	ND	µg/L	10		EPA 624	12/18/2019	
Secondary Effluent	24	Chloroethane	<	ND	µg/L	0.5		EPA 624	12/2/2020	
Secondary Effluent	24	Chloroethane	<	ND	µg/L	0.5	0.18	EPA 624.1	11/18/2021	12/13/2021
Secondary Effluent	25	2-Chloroethyl Vinyl Ether	<	ND	µg/L	5		EPA 624	12/1/2016	
Secondary Effluent	25	2-Chloroethyl Vinyl Ether	<	ND	µg/L	5		EPA 624	11/29/2017	
Secondary Effluent	25	2-Chloroethyl Vinyl Ether	<	ND	µg/L	5		EPA 624	12/5/2018	
Secondary Effluent	25	2-Chloroethyl Vinyl Ether	<	ND	µg/L	10		EPA 624	12/18/2019	
Secondary Effluent	25	2-Chloroethyl Vinyl Ether	<	ND	µg/L	1		EPA 624	12/2/2020	
Secondary Effluent	25	2-Chloroethyl Vinyl Ether	<	ND	µg/L	1	0.72	EPA 624.1	11/18/2021	12/13/2021
Secondary Effluent	26	Chloroform	<	ND	µg/L	1		EPA 624	12/1/2016	
Secondary Effluent	26	Chloroform	<	ND	µg/L	1		EPA 624	11/29/2017	
Secondary Effluent	26	Chloroform	<	ND	µg/L	1		EPA 624	12/5/2018	
Secondary Effluent	26	Chloroform	<	ND	µg/L	5		EPA 624	12/18/2019	
Secondary Effluent	26	Chloroform	<	ND	µg/L	0.5		EPA 624	12/2/2020	
Secondary Effluent	26	Chloroform	<	ND	µg/L	0.5	0.079	EPA 624.1	11/18/2021	12/13/2021
Secondary Effluent	27	Dichlorobromomethane	<	ND	µg/L	1		EPA 624	12/1/2016	
Secondary Effluent	27	Dichlorobromomethane	<	ND	µg/L	1		EPA 624	11/29/2017	
Secondary Effluent	27	Dichlorobromomethane	<	ND	µg/L	1		EPA 624	12/5/2018	
Secondary Effluent	27	Dichlorobromomethane	<	ND	µg/L	5		EPA 624	12/18/2019	
Secondary Effluent	27	Dichlorobromomethane	<	ND	µg/L	0.5		EPA 624	12/2/2020	
Secondary Effluent	27	Dichlorobromomethane	<	ND	µg/L	0.5	0.058	EPA 624.1	11/18/2021	12/13/2021
Secondary Effluent	28	1,1-Dichloroethane (1,1-DCA)	<	ND	µg/L	1		EPA 624	12/1/2016	
Secondary Effluent	28	1,1-Dichloroethane (1,1-DCA)	<	ND	µg/L	1		EPA 624	11/29/2017	
Secondary Effluent	28	1,1-Dichloroethane (1,1-DCA)	<	ND	µg/L	1		EPA 624	12/5/2018	
Secondary Effluent	28	1,1-Dichloroethane (1,1-DCA)	<	ND	µg/L	5		EPA 624	12/18/2019	
Secondary Effluent	28	1,1-Dichloroethane (1,1-DCA)	<	ND	µg/L	0.5		EPA 624	12/2/2020	

Secondary Effluent and Receiving Water Characterization Data

Location	PTP	Analyte	Qualifier	Result	Units	RL	MDL	Analytical Method	Sample Date	Analysis Date
Secondary Effluent	28	1,1-Dichloroethane (1,1-DCA)	<	ND	µg/L	0.5	0.08	EPA 624.1	11/18/2021	12/13/2021
Secondary Effluent	29	1,2-Dichloroethane (1,2-DCA)	<	ND	µg/L	1		EPA 624	12/1/2016	
Secondary Effluent	29	1,2-Dichloroethane (1,2-DCA)	<	ND	µg/L	1		EPA 624	11/29/2017	
Secondary Effluent	29	1,2-Dichloroethane (1,2-DCA)	<	ND	µg/L	1		EPA 624	12/5/2018	
Secondary Effluent	29	1,2-Dichloroethane (1,2-DCA)	<	ND	µg/L	5		EPA 624	12/18/2019	
Secondary Effluent	29	1,2-Dichloroethane (1,2-DCA)	<	ND	µg/L	0.5		EPA 624	12/2/2020	
Secondary Effluent	29	1,2-Dichloroethane (1,2-DCA)	<	ND	µg/L	0.5	0.06	EPA 624.1	11/18/2021	12/13/2021
Secondary Effluent	30	1,1-Dichloroethylene (1,1-DCE)	<	ND	µg/L	1		EPA 624	12/1/2016	
Secondary Effluent	30	1,1-Dichloroethylene (1,1-DCE)	<	ND	µg/L	1		EPA 624	11/29/2017	
Secondary Effluent	30	1,1-Dichloroethylene (1,1-DCE)	<	ND	µg/L	1		EPA 624	12/5/2018	
Secondary Effluent	30	1,1-Dichloroethylene (1,1-DCE)	<	ND	µg/L	5		EPA 624	12/18/2019	
Secondary Effluent	30	1,1-Dichloroethylene (1,1-DCE)	<	ND	µg/L	0.5		EPA 624	12/2/2020	
Secondary Effluent	30	1,1-Dichloroethylene (1,1-DCE)	<	ND	µg/L	0.5	0.12	EPA 624.1	11/18/2021	12/13/2021
Secondary Effluent	31	1,2-Dichloropropane	<	ND	µg/L	1		EPA 624	12/1/2016	
Secondary Effluent	31	1,2-Dichloropropane	<	ND	µg/L	1		EPA 624	11/29/2017	
Secondary Effluent	31	1,2-Dichloropropane	<	ND	µg/L	1		EPA 624	12/5/2018	
Secondary Effluent	31	1,2-Dichloropropane	<	ND	µg/L	5		EPA 624	12/18/2019	
Secondary Effluent	31	1,2-Dichloropropane	<	ND	µg/L	0.5		EPA 624	12/2/2020	
Secondary Effluent	31	1,2-Dichloropropane	<	ND	µg/L	0.5	0.066	EPA 624.1	11/18/2021	12/13/2021
Secondary Effluent	32	1,3-Dichloropropene	<	ND	µg/L	1		EPA 624	11/29/2017	
Secondary Effluent	32	1,3-Dichloropropene	<	ND	µg/L	1		EPA 624	12/5/2018	
Secondary Effluent	32	1,3-Dichloropropene	<	ND	µg/L	5		EPA 624	12/18/2019	
Secondary Effluent	32	1,3-Dichloropropene	<	ND	µg/L	0.5		EPA 624	12/2/2020	
Secondary Effluent	32	1,3-Dichloropropene	<	ND	µg/L	0.5	0.11	EPA 624.1	11/18/2021	12/13/2021
Secondary Effluent	33	Ethylbenzene	<	ND	µg/L	1		EPA 624	12/1/2016	
Secondary Effluent	33	Ethylbenzene	<	ND	µg/L	1		EPA 624	11/29/2017	
Secondary Effluent	33	Ethylbenzene	<	ND	µg/L	1		EPA 624	12/5/2018	
Secondary Effluent	33	Ethylbenzene	<	ND	µg/L	5		EPA 624	12/18/2019	
Secondary Effluent	33	Ethylbenzene	<	ND	µg/L	2		EPA 624	12/2/2020	
Secondary Effluent	33	Ethylbenzene	<	ND	µg/L	2	0.098	EPA 624.1	11/18/2021	12/13/2021
Secondary Effluent	34	Methyl Bromide	<	ND	µg/L	1		EPA 624	12/1/2016	
Secondary Effluent	34	Methyl Bromide	<	ND	µg/L	1		EPA 624	11/29/2017	
Secondary Effluent	34	Methyl Bromide	<	ND	µg/L	1		EPA 624	12/5/2018	
Secondary Effluent	34	Methyl Bromide	<	ND	µg/L	10		EPA 624	12/18/2019	
Secondary Effluent	34	Methyl Bromide	<	ND	µg/L	0.5		EPA 624	12/2/2020	
Secondary Effluent	34	Methyl Bromide	<	ND	µg/L	0.5	0.19	EPA 624.1	11/18/2021	12/13/2021
Secondary Effluent	35	Methyl Chloride	<	ND	µg/L	1		EPA 624	12/1/2016	
Secondary Effluent	35	Methyl Chloride	<	ND	µg/L	1		EPA 624	11/29/2017	

Secondary Effluent and Receiving Water Characterization Data

Location	PTP	Analyte	Qualifier	Result	Units	RL	MDL	Analytical Method	Sample Date	Analysis Date
Secondary Effluent	35	Methyl Chloride	<	ND	µg/L	1		EPA 624	12/5/2018	
Secondary Effluent	35	Methyl Chloride	<	ND	µg/L	10		EPA 624	12/18/2019	
Secondary Effluent	35	Methyl Chloride	<	ND	µg/L	2		EPA 624	12/2/2020	
Secondary Effluent	35	Methyl Chloride	<	ND	µg/L	2	0.19	EPA 624.1	11/18/2021	12/13/2021
Secondary Effluent	36	Methylene Chloride	<	ND	µg/L	1		EPA 624	12/1/2016	
Secondary Effluent	36	Methylene Chloride	<	ND	µg/L	1		EPA 624	11/29/2017	
Secondary Effluent	36	Methylene Chloride	<	ND	µg/L	1		EPA 624	12/5/2018	
Secondary Effluent	36	Methylene Chloride	<	ND	µg/L	5		EPA 624	12/18/2019	
Secondary Effluent	36	Methylene Chloride	<	ND	µg/L	2		EPA 624	12/2/2020	
Secondary Effluent	36	Methylene Chloride	<	ND	µg/L	2	0.076	EPA 624.1	11/18/2021	12/13/2021
Secondary Effluent	37	1,1,2,2-Tetrachloroethane	<	ND	µg/L	1		EPA 624	12/1/2016	
Secondary Effluent	37	1,1,2,2-Tetrachloroethane	<	ND	µg/L	1		EPA 624	11/29/2017	
Secondary Effluent	37	1,1,2,2-Tetrachloroethane	<	ND	µg/L	1		EPA 624	12/5/2018	
Secondary Effluent	37	1,1,2,2-Tetrachloroethane	<	ND	µg/L	5		EPA 624	12/18/2019	
Secondary Effluent	37	1,1,2,2-Tetrachloroethane	<	ND	µg/L	0.5		EPA 624	12/2/2020	
Secondary Effluent	37	1,1,2,2-Tetrachloroethane	<	ND	µg/L	0.5	0.11	EPA 624.1	11/18/2021	12/13/2021
Secondary Effluent	38	Tetrachloroethylene (PCE)	<	ND	µg/L	1		EPA 624	12/1/2016	
Secondary Effluent	38	Tetrachloroethylene (PCE)	<	ND	µg/L	1		EPA 624	11/29/2017	
Secondary Effluent	38	Tetrachloroethylene (PCE)	<	ND	µg/L	1		EPA 624	12/5/2018	
Secondary Effluent	38	Tetrachloroethylene (PCE)	<	ND	µg/L	5		EPA 624	12/18/2019	
Secondary Effluent	38	Tetrachloroethylene (PCE)	<	ND	µg/L	0.5		EPA 624	12/2/2020	
Secondary Effluent	38	Tetrachloroethylene (PCE)	<	ND	µg/L	0.5	0.11	EPA 624.1	11/18/2021	12/13/2021
Secondary Effluent	39	Toluene	<	ND	µg/L	1		EPA 624	12/1/2016	
Secondary Effluent	39	Toluene	<	ND	µg/L	1		EPA 624	11/29/2017	
Secondary Effluent	39	Toluene	<	ND	µg/L	1		EPA 624	12/5/2018	
Secondary Effluent	39	Toluene	<	ND	µg/L	5		EPA 624	12/18/2019	
Secondary Effluent	39	Toluene	<	ND	µg/L	0.5		EPA 624	12/2/2020	
Secondary Effluent	39	Toluene	<	ND	µg/L	2	0.07	EPA 624.1	11/18/2021	12/13/2021
Secondary Effluent	40	trans-1,2-Dichloroethylene (t-1,2-DCE)	<	ND	µg/L	1		EPA 624	12/1/2016	
Secondary Effluent	40	trans-1,2-Dichloroethylene (t-1,2-DCE)	<	ND	µg/L	1		EPA 624	11/29/2017	
Secondary Effluent	40	trans-1,2-Dichloroethylene (t-1,2-DCE)	<	ND	µg/L	1		EPA 624	12/5/2018	
Secondary Effluent	40	trans-1,2-Dichloroethylene (t-1,2-DCE)	<	ND	µg/L	5		EPA 624	12/18/2019	
Secondary Effluent	40	trans-1,2-Dichloroethylene (t-1,2-DCE)	<	ND	µg/L	1		EPA 624	12/2/2020	
Secondary Effluent	40	trans-1,2-Dichloroethylene (t-1,2-DCE)	<	ND	µg/L	1	0.11	EPA 624.1	11/18/2021	12/13/2021
Secondary Effluent	41	1,1,1-Trichloroethane (1,1,1-TCA)	<	ND	µg/L	1		EPA 624	12/1/2016	
Secondary Effluent	41	1,1,1-Trichloroethane (1,1,1-TCA)	<	ND	µg/L	1		EPA 624	11/29/2017	
Secondary Effluent	41	1,1,1-Trichloroethane (1,1,1-TCA)	<	ND	µg/L	1		EPA 624	12/5/2018	
Secondary Effluent	41	1,1,1-Trichloroethane (1,1,1-TCA)	<	ND	µg/L	5		EPA 624	12/18/2019	

Secondary Effluent and Receiving Water Characterization Data

Location	PTP	Analyte	Qualifier	Result	Units	RL	MDL	Analytical Method	Sample Date	Analysis Date
Secondary Effluent	41	1,1,1-Trichloroethane (1,1,1-TCA)	<	ND	µg/L	0.5		EPA 624	12/2/2020	
Secondary Effluent	41	1,1,1-Trichloroethane (1,1,1-TCA)	<	ND	µg/L	0.5	0.06	EPA 624.1	11/18/2021	12/13/2021
Secondary Effluent	42	1,1,2-Trichloroethane (1,1,2-TCA)	<	ND	µg/L	1		EPA 624	12/1/2016	
Secondary Effluent	42	1,1,2-Trichloroethane (1,1,2-TCA)	<	ND	µg/L	1		EPA 624	11/29/2017	
Secondary Effluent	42	1,1,2-Trichloroethane (1,1,2-TCA)	<	ND	µg/L	1		EPA 624	12/5/2018	
Secondary Effluent	42	1,1,2-Trichloroethane (1,1,2-TCA)	<	ND	µg/L	5		EPA 624	12/18/2019	
Secondary Effluent	42	1,1,2-Trichloroethane (1,1,2-TCA)	<	ND	µg/L	0.5		EPA 624	12/2/2020	
Secondary Effluent	42	1,1,2-Trichloroethane (1,1,2-TCA)	<	ND	µg/L	0.5	0.068	EPA 624.1	11/18/2021	12/13/2021
Secondary Effluent	43	Trichloroethylene (TCE)	<	ND	µg/L	1		EPA 624	12/1/2016	
Secondary Effluent	43	Trichloroethylene (TCE)	<	ND	µg/L	1		EPA 624	11/29/2017	
Secondary Effluent	43	Trichloroethylene (TCE)	<	ND	µg/L	1		EPA 624	12/5/2018	
Secondary Effluent	43	Trichloroethylene (TCE)	<	ND	µg/L	5		EPA 624	12/18/2019	
Secondary Effluent	43	Trichloroethylene (TCE)	<	ND	µg/L	2		EPA 624	12/2/2020	
Secondary Effluent	43	Trichloroethylene (TCE)	<	ND	µg/L	2	0.082	EPA 624.1	11/18/2021	12/13/2021
Secondary Effluent	44	Vinyl Chloride (VC)	<	ND	µg/L	1		EPA 624	12/1/2016	
Secondary Effluent	44	Vinyl Chloride (VC)	<	ND	µg/L	1		EPA 624	11/29/2017	
Secondary Effluent	44	Vinyl Chloride (VC)	<	ND	µg/L	1		EPA 624	12/5/2018	
Secondary Effluent	44	Vinyl Chloride (VC)	<	ND	µg/L	10		EPA 624	12/18/2019	
Secondary Effluent	44	Vinyl Chloride (VC)	<	ND	µg/L	0.5		EPA 624	12/2/2020	
Secondary Effluent	44	Vinyl Chloride (VC)	<	ND	µg/L	0.5	0.12	EPA 624.1	11/18/2021	12/13/2021
Secondary Effluent	45	2-Chlorophenol	<	ND	µg/L	1		EPA 625	12/1/2016	
Secondary Effluent	45	2-Chlorophenol	<	ND	µg/L	1		EPA 625	11/29/2017	
Secondary Effluent	45	2-Chlorophenol	<	ND	µg/L	10		EPA 625	12/5/2018	
Secondary Effluent	45	2-Chlorophenol	<	ND	µg/L	10		EPA 625	12/18/2019	
Secondary Effluent	45	2-Chlorophenol	<	ND	µg/L	9		EPA 625	12/2/2020	
Secondary Effluent	45	2-Chlorophenol	<	ND	µg/L	10	2.7	EPA 625	11/18/2021	12/13/2021
Secondary Effluent	46	2,4-Dichlorophenol	<	ND	µg/L	1		EPA 625	12/1/2016	
Secondary Effluent	46	2,4-Dichlorophenol	<	ND	µg/L	1		EPA 625	11/29/2017	
Secondary Effluent	46	2,4-Dichlorophenol	<	ND	µg/L	10		EPA 625	12/5/2018	
Secondary Effluent	46	2,4-Dichlorophenol	<	ND	µg/L	10		EPA 625	12/18/2019	
Secondary Effluent	46	2,4-Dichlorophenol	<	ND	µg/L	8		EPA 625	12/2/2020	
Secondary Effluent	46	2,4-Dichlorophenol	<	ND	µg/L	5	3.5	EPA 625	11/18/2021	12/13/2021
Secondary Effluent	47	2,4-Dimethylphenol	<	ND	µg/L	1		EPA 625	12/1/2016	
Secondary Effluent	47	2,4-Dimethylphenol	<	ND	µg/L	1		EPA 625	11/29/2017	
Secondary Effluent	47	2,4-Dimethylphenol	<	ND	µg/L	10		EPA 625	12/5/2018	
Secondary Effluent	47	2,4-Dimethylphenol	<	ND	µg/L	10		EPA 625	12/18/2019	
Secondary Effluent	47	2,4-Dimethylphenol	<	ND	µg/L	8		EPA 625	12/2/2020	
Secondary Effluent	47	2,4-Dimethylphenol	<	ND	µg/L	10	3	EPA 625	11/18/2021	12/13/2021

Secondary Effluent and Receiving Water Characterization Data

Location	PTP	Analyte	Qualifier	Result	Units	RL	MDL	Analytical Method	Sample Date	Analysis Date
Secondary Effluent	48	2-Methyl-4,6-Dinitrophenol	<	ND	µg/L	5		EPA 625	12/1/2016	
Secondary Effluent	48	2-Methyl-4,6-Dinitrophenol	<	ND	µg/L	5		EPA 625	11/29/2017	
Secondary Effluent	48	2-Methyl-4,6-Dinitrophenol	<	ND	µg/L	25		EPA 625	12/5/2018	
Secondary Effluent	48	2-Methyl-4,6-Dinitrophenol	<	ND	µg/L	25		EPA 625	12/18/2019	
Secondary Effluent	48	2-Methyl-4,6-Dinitrophenol	<	ND	µg/L	25		EPA 625	12/2/2020	
Secondary Effluent	48	2-Methyl-4,6-Dinitrophenol	<	ND	µg/L	50	3.7	EPA 625	11/18/2021	12/13/2021
Secondary Effluent	49	2,4-Dinitrophenol	<	ND	µg/L	1		EPA 625	12/1/2016	
Secondary Effluent	49	2,4-Dinitrophenol	<	ND	µg/L	10		EPA 625	11/29/2017	
Secondary Effluent	49	2,4-Dinitrophenol	<	ND	µg/L	25		EPA 625	12/5/2018	
Secondary Effluent	49	2,4-Dinitrophenol	<	ND	µg/L	25		EPA 625	12/18/2019	
Secondary Effluent	49	2,4-Dinitrophenol	<	ND	µg/L	25		EPA 625	12/2/2020	
Secondary Effluent	49	2,4-Dinitrophenol	<	ND	µg/L	25	2.6	EPA 625	11/18/2021	12/13/2021
Secondary Effluent	50	2-Nitrophenol	<	ND	µg/L	1		EPA 625	12/1/2016	
Secondary Effluent	50	2-Nitrophenol	<	ND	µg/L	1		EPA 625	11/29/2017	
Secondary Effluent	50	2-Nitrophenol	<	ND	µg/L	10		EPA 625	12/5/2018	
Secondary Effluent	50	2-Nitrophenol	<	ND	µg/L	10		EPA 625	12/18/2019	
Secondary Effluent	50	2-Nitrophenol	<	ND	µg/L	10		EPA 625	12/2/2020	
Secondary Effluent	50	2-Nitrophenol	<	ND	µg/L	50	2.5	EPA 625	11/18/2021	12/13/2021
Secondary Effluent	51	4-Nitrophenol	<	ND	µg/L	5		EPA 625	12/1/2016	
Secondary Effluent	51	4-Nitrophenol	<	ND	µg/L	5		EPA 625	11/29/2017	
Secondary Effluent	51	4-Nitrophenol	<	ND	µg/L	25		EPA 625	12/5/2018	
Secondary Effluent	51	4-Nitrophenol	<	ND	µg/L	25		EPA 625	12/18/2019	
Secondary Effluent	51	4-Nitrophenol	<	ND	µg/L	7		EPA 625	12/2/2020	
Secondary Effluent	51	4-Nitrophenol	<	ND	µg/L	50	2.8	EPA 625	11/18/2021	12/13/2021
Secondary Effluent	52	3-Methyl-4-Chlorophenol	<	ND	µg/L	1		EPA 625	12/1/2016	
Secondary Effluent	52	3-Methyl-4-Chlorophenol	<	ND	µg/L	1		EPA 625	11/29/2017	
Secondary Effluent	52	3-Methyl-4-Chlorophenol	<	ND	µg/L	20		EPA 625	12/5/2018	
Secondary Effluent	52	3-Methyl-4-Chlorophenol	<	ND	µg/L	20		EPA 625	12/18/2019	
Secondary Effluent	52	3-Methyl-4-Chlorophenol	<	ND	µg/L	9		EPA 625	12/2/2020	
Secondary Effluent	52	3-Methyl-4-Chlorophenol	<	ND	µg/L	25	3.4	EPA 625	11/18/2021	12/13/2021
Secondary Effluent	53	Pentachlorophenol	<	ND	µg/L	1		EPA 625	12/1/2016	
Secondary Effluent	53	Pentachlorophenol	<	ND	µg/L	1		EPA 625	11/29/2017	
Secondary Effluent	53	Pentachlorophenol	<	ND	µg/L	25		EPA 625	12/5/2018	
Secondary Effluent	53	Pentachlorophenol	<	ND	µg/L	25		EPA 625	12/18/2019	
Secondary Effluent	53	Pentachlorophenol	<	ND	µg/L	10		EPA 625	12/2/2020	
Secondary Effluent	53	Pentachlorophenol	<	ND	µg/L	25	4.9	EPA 625	11/18/2021	12/13/2021
Secondary Effluent	54	Phenol	<	ND	µg/L	1		EPA 625	12/1/2016	
Secondary Effluent	54	Phenol	<	ND	µg/L	1		EPA 625	11/29/2017	

Secondary Effluent and Receiving Water Characterization Data

Location	PTP	Analyte	Qualifier	Result	Units	RL	MDL	Analytical Method	Sample Date	Analysis Date
Secondary Effluent	54	Phenol	<	ND	µg/L	10		EPA 625	12/5/2018	
Secondary Effluent	54	Phenol	<	ND	µg/L	10		EPA 625	12/18/2019	
Secondary Effluent	54	Phenol	<	ND	µg/L	4		EPA 625	12/2/2020	
Secondary Effluent	54	Phenol	<	ND	µg/L	5	2.5	EPA 625	11/18/2021	12/13/2021
Secondary Effluent	55	2,4,6-Trichlorophenol	<	ND	µg/L	1		EPA 625	12/1/2016	
Secondary Effluent	55	2,4,6-Trichlorophenol	<	ND	µg/L	1		EPA 625	11/29/2017	
Secondary Effluent	55	2,4,6-Trichlorophenol	<	ND	µg/L	10		EPA 625	12/5/2018	
Secondary Effluent	55	2,4,6-Trichlorophenol	<	ND	µg/L	10		EPA 625	12/18/2019	
Secondary Effluent	55	2,4,6-Trichlorophenol	<	ND	µg/L	8		EPA 625	12/2/2020	
Secondary Effluent	55	2,4,6-Trichlorophenol	<	ND	µg/L	50	3.6	EPA 625	11/18/2021	12/13/2021
Secondary Effluent	56	Acenaphthene	<	ND	µg/L	0.5	0.27	EPA 610	11/18/2021	12/13/2021
Secondary Effluent	57	Acenaphthylene	<	ND	µg/L	0.2	0.011	EPA 610	11/18/2021	12/13/2021
Secondary Effluent	58	Anthracene	<	ND	µg/L	0.2	0.029	EPA 610	11/18/2021	12/13/2021
Secondary Effluent	59	Benidine	<	ND	µg/L	25	2.5	EPA 625	11/18/2021	12/13/2021
Secondary Effluent	60	Benzo(a)anthracene	<	ND	µg/L	0.2	0.023	EPA 610	11/18/2021	12/13/2021
Secondary Effluent	61	Benzo(a)pyrene	<	ND	µg/L	0.1	0.03	EPA 610	11/18/2021	12/13/2021
Secondary Effluent	62	Benzo(b)fluoranthene	<	ND	µg/L	0.5	0.03	EPA 610	11/18/2021	12/13/2021
Secondary Effluent	63	Benzo(g,h,i)perylene	<	ND	µg/L	0.2	0.029	EPA 610	11/18/2021	12/13/2021
Secondary Effluent	64	Benzo(k)fluoranthene	<	ND	µg/L	0.2	0.029	EPA 610	11/18/2021	12/13/2021
Secondary Effluent	65	Bis(2-chloroethoxy)methane	<	ND	µg/L	25	2.8	EPA 625	11/18/2021	12/13/2021
Secondary Effluent	66	Bis(2-chloroethyl)ether	<	ND	µg/L	5	2.5	EPA 625	11/18/2021	12/13/2021
Secondary Effluent	67	Bis(2-chloroisopropyl)ether	<	ND	µg/L	50	2.5	EPA 625	11/18/2021	12/13/2021
Secondary Effluent	68	Bis(2-ethylhexyl)phthalate (DEHP)	<	ND	µg/L	7.5	3.3	EPA 625	11/18/2021	12/13/2021
Secondary Effluent	69	4-Bromophenyl phenyl ether	<	ND	µg/L	50	2.5	EPA 625	11/18/2021	12/13/2021
Secondary Effluent	70	Butylbenzyl phthalate	<	ND	µg/L	50	6	EPA 625	11/18/2021	12/13/2021
Secondary Effluent	71	2-Chloronaphthalene	<	ND	µg/L	50	2.5	EPA 625	11/18/2021	12/13/2021
Secondary Effluent	72	4-Chlorophenyl phenyl ether	<	ND	µg/L	25	2.5	EPA 625	11/18/2021	12/13/2021
Secondary Effluent	73	Chrysene	<	ND	µg/L	0.2	0.028	EPA 610	11/18/2021	12/13/2021
Secondary Effluent	74	Dibenzo(a,h)anthracene	<	ND	µg/L	0.1	0.027	EPA 610	11/18/2021	12/13/2021
Secondary Effluent	75	1,2-Dichlorobenzene (o-DCB)	<	ND	µg/L	0.5	0.059	EPA 624.1	11/18/2021	12/13/2021
Secondary Effluent	76	1,3-Dichlorobenzene (m-DCB)	<	ND	µg/L	2	0.077	EPA 624.1	11/18/2021	12/13/2021
Secondary Effluent	77	1,4-Dichlorobenzene (p-DCB)	<	ND	µg/L	0.5	0.26	EPA 624.1	11/18/2021	12/13/2021
Secondary Effluent	78	3,3'-Dichlorobenzidine	<	ND	µg/L	25	2.5	EPA 625	11/18/2021	12/13/2021
Secondary Effluent	79	Diethylphthalate	<	ND	µg/L	10	2.7	EPA 625	11/18/2021	12/13/2021
Secondary Effluent	80	Dimethylphthalate	<	ND	µg/L	10	5.5	EPA 625	11/18/2021	12/13/2021
Secondary Effluent	81	Di-n-butylphthalate	<	ND	µg/L	50	3.7	EPA 625	11/18/2021	12/13/2021
Secondary Effluent	82	2,4-Dinitrotoluene	<	ND	µg/L	25	3	EPA 625	11/18/2021	12/13/2021
Secondary Effluent	83	2,6-Dinitrotoluene	<	ND	µg/L	25	3.9	EPA 625	11/18/2021	12/13/2021

Secondary Effluent and Receiving Water Characterization Data

Location	PTP	Analyte	Qualifier	Result	Units	RL	MDL	Analytical Method	Sample Date	Analysis Date
Secondary Effluent	84	Di-n-octylphthalate	<	ND	µg/L	50	3.6	EPA 625	11/18/2021	12/13/2021
Secondary Effluent	85	1,2-Diphenylhydrazine	<	ND	µg/L	5	2.5	EPA 625	11/18/2021	12/13/2021
Secondary Effluent	86	Fluoranthene	<	ND	µg/L	0.2	0.033	EPA 610	11/18/2021	12/13/2021
Secondary Effluent	87	Fluorene	<	ND	µg/L	0.2	0.15	EPA 610	11/18/2021	12/13/2021
Secondary Effluent	88	Hexachlorobenzene	<	ND	µg/L	5	2.5	EPA 625	11/18/2021	12/13/2021
Secondary Effluent	89	Hexachlorobutadiene	<	ND	µg/L	1	0.13	EPA 624.1	11/18/2021	12/13/2021
Secondary Effluent	90	Hexachlorocyclopentadiene	<	ND	µg/L	25	2.5	EPA 625	11/18/2021	12/13/2021
Secondary Effluent	91	Hexachloroethane	<	ND	µg/L	5	2.5	EPA 625	11/18/2021	12/13/2021
Secondary Effluent	92	Indeno(1,2,3-c,d)pyrene	<	ND	µg/L	0.05	0.035	EPA 610	11/18/2021	12/13/2021
Secondary Effluent	93	Isophorone	<	ND	µg/L	5	2.8	EPA 625	11/18/2021	12/13/2021
Secondary Effluent	94	Naphthalene	<	ND	µg/L	0.2	0.018	EPA 610	11/18/2021	12/13/2021
Secondary Effluent	94	Naphthalene	<	ND	µg/L	10	0.018	EPA 624.1	11/18/2021	12/13/2021
Secondary Effluent	95	Nitrobenzene	<	ND	µg/L	50	2.6	EPA 625	11/18/2021	12/13/2021
Secondary Effluent	96	N-Nitrosodiethylamine	<	ND	µg/L	25	2.5	EPA 625	11/18/2021	12/13/2021
Secondary Effluent	97	N-Nitroso-di-n-propylamine	<	ND	µg/L	25	2.5	EPA 625	11/18/2021	12/13/2021
Secondary Effluent	98	N-Nitrosodiphenylamine	<	ND	µg/L	5	3.6	EPA 625	11/18/2021	12/13/2021
Secondary Effluent	99	Phenanthrene	<	ND	µg/L	0.2	0.012	EPA 610	11/18/2021	12/13/2021
Secondary Effluent	100	Pyrene	<	ND	µg/L	0.2	0.04	EPA 610	11/18/2021	12/13/2021
Secondary Effluent	101	1,2,4-Trichlorobenzene	<	ND	µg/L	5	0.79	EPA 624.1	11/18/2021	12/13/2021
Secondary Effluent	102	Aldrin	<	ND	µg/L	0.025	0.008	EPA 608	11/18/2021	12/13/2021
Secondary Effluent	103	alpha BHC	<	ND	µg/L	0.05	0.008	EPA 608	11/18/2021	12/13/2021
Secondary Effluent	104	beta BHC	<	ND	µg/L	0.025	0.009	EPA 608	11/18/2021	12/13/2021
Secondary Effluent	105	gamma BHC	<	ND	µg/L	0.1	0.007	EPA 608	11/18/2021	12/13/2021
Secondary Effluent	106	delta-BHC	<	ND	µg/L	0.025	0.007	EPA 608	11/18/2021	12/13/2021
Secondary Effluent	107	Chlordane	<	ND	µg/L	0.5	0.17	EPA 608	11/18/2021	12/13/2021
Secondary Effluent	108	4,4'-DDT	<	ND	µg/L	0.05	0.005	EPA 608	11/18/2021	12/13/2021
Secondary Effluent	109	4,4'-DDE	<	ND	µg/L	0.25	0.01	EPA 608	11/18/2021	12/13/2021
Secondary Effluent	110	4,4'-DDD	<	ND	µg/L	0.25	0.05	EPA 608	11/18/2021	12/13/2021
Secondary Effluent	111	Dieldrin	<	ND	µg/L	0.05	0.009	EPA 608	11/18/2021	12/13/2021
Secondary Effluent	112	Endosulfan I	<	ND	µg/L	0.1	0.008	EPA 608	11/18/2021	12/13/2021
Secondary Effluent	113	Endosulfan II	<	ND	µg/L	0.05	0.005	EPA 608	11/18/2021	12/13/2021
Secondary Effluent	114	Endosulfan sulfate	<	ND	µg/L	0.25	0.012	EPA 608	11/18/2021	12/13/2021
Secondary Effluent	115	Endrin	<	ND	µg/L	0.05	0.01	EPA 608	11/18/2021	12/13/2021
Secondary Effluent	116	Endrin aldehyde	<	ND	µg/L	0.05	0.01	EPA 608	11/18/2021	12/13/2021
Secondary Effluent	117	Heptachlor	<	ND	µg/L	0.05	0.009	EPA 608	11/18/2021	12/13/2021
Secondary Effluent	118	Heptachlor Epoxide	<	ND	µg/L	0.05	0.008	EPA 608	11/18/2021	12/13/2021
Secondary Effluent	119	Aroclor 1016	<	ND	µg/L	2.5	2.5	EPA 608	11/18/2021	12/13/2021
Secondary Effluent	120	Aroclor 1221	<	ND	µg/L	2.5	2.5	EPA 608	11/18/2021	12/13/2021

Secondary Effluent and Receiving Water Characterization Data

Location	PTP	Analyte	Qualifier	Result	Units	RL	MDL	Analytical Method	Sample Date	Analysis Date
Secondary Effluent	121	Aroclor 1232	<	ND	µg/L	2.5	2.5	EPA 608	11/18/2021	12/13/2021
Secondary Effluent	122	Aroclor 1242	<	ND	µg/L	2.5	2.5	EPA 608	11/18/2021	12/13/2021
Secondary Effluent	123	Aroclor 1248	<	ND	µg/L	2.5	2.5	EPA 608	11/18/2021	12/13/2021
Secondary Effluent	124	Aroclor 1254	<	ND	µg/L	2.5	2.5	EPA 608	11/18/2021	12/13/2021
Secondary Effluent	125	Aroclor 1260	<	ND	µg/L	2.5	2.5	EPA 608	11/18/2021	12/13/2021
Secondary Effluent	126	Toxaphene	<	ND	µg/L	2.5	0.26	EPA 608	11/18/2021	12/13/2021
Secondary Effluent		Aluminum (Al)	=	110	µg/L	50	14	EPA 200.7	11/20/2019	
Secondary Effluent		Aluminum (Al)	=	250	µg/L	50	14	EPA 200.7	11/18/2021	11/23/2021
Secondary Effluent		Barium (Ba)	=	46	µg/L	100	12	EPA 200.7	11/20/2019	
Secondary Effluent		Iron (Fe)	=	150	µg/L	100	14	EPA 200.7	11/20/2019	
Secondary Effluent		Iron (Fe) Dissolved	J	22	µg/L	100	14	EPA 200.7	11/18/2021	11/30/2021
Secondary Effluent		Manganese (Mn)	=	21	µg/L	20	0.8	EPA 200.7	11/20/2019	
Secondary Effluent		Manganese (Mn) Dissolved	<	ND	µg/L	20	0.8	EPA 200.7	11/18/2021	11/30/2021
Secondary Effluent		Chloride (Cl)	=	53	mg/L	1	0.075	EPA 300.0	11/18/2021	11/18/2021
Secondary Effluent		Fluoride (F)	=	0.3	mg/L	0.1	0.026	EPA 300.0	11/20/2019	
Secondary Effluent		Fluoride (F)	=	0.52	mg/L	0.1	0.026	EPA 300.0	11/18/2021	11/18/2021
Secondary Effluent		Nitrate as N (NO3-N)	=	1.3	mg/L	0.4	0.12	EPA 300.0	11/20/2019	
Secondary Effluent		Nitrite as N (NO2-N)	<	ND	mg/L	0.4	0.17	EPA 300.0	11/20/2019	
Secondary Effluent		Sulfate (SO4)	=	35	mg/L	0.5	0.14	EPA 300.0	11/18/2021	11/18/2021
Secondary Effluent		MBAS (LAS Mole. Wt 340.0)	<	ND	mg/L	0.1	0.047	SM 5540C	11/20/2019	
Secondary Effluent		MBAS (LAS Mole. Wt 340.0)	=	0.14	mg/L	0.1	0.047	SM 5540C	11/18/2021	11/18/2021
Secondary Effluent		Methyl tert-Butyl Ether	<	ND	µg/L	3	0.069	EPA 624.1	11/18/2021	12/13/2021
Secondary Effluent		Styrene	<	ND	µg/L	0.5	0.059	EPA 624.1	11/18/2021	12/13/2021
Secondary Effluent		Xylenes	<	ND	µg/L	0.5	0.26	EPA 624.1	11/18/2021	12/13/2021
Secondary Effluent		Total Trihalomethanes (TTHM)	<	ND	µg/L	0.5	0.22	EPA 624.1	11/18/2021	12/13/2021
Secondary Effluent		Boron (B)	=	270	µg/L	100	32	EPA 200.7	11/20/2019	
Secondary Effluent		Boron (B)	=	260	µg/L	100	32	EPA 200.7	11/18/2021	11/23/2021
Secondary Effluent		Hardness, Total (as CaCO3)	=	270	mg/L			Calculated	11/20/2019	
Secondary Effluent		Hardness, Total (as CaCO3)	=	260	mg/L	6.6		Calculated	11/18/2021	11/24/2021
Secondary Effluent		Ammonia-N	<	ND	mg/L				11/28/2018	
Secondary Effluent		Ammonia-N	<	ND	mg/L				12/12/2018	
Secondary Effluent		Ammonia-N	=	22	mg/L				1/2/2019	
Secondary Effluent		Ammonia-N	=	7.5	mg/L				1/16/2019	
Secondary Effluent		Ammonia-N	=	0.45	mg/L				2/6/2019	
Secondary Effluent		Ammonia-N	=	1.1	mg/L				2/13/2019	
Secondary Effluent		Ammonia-N	<	ND	mg/L				3/6/2019	
Secondary Effluent		Ammonia-N	=	0.26	mg/L				3/20/2019	
Secondary Effluent		Ammonia-N	=	0.27	mg/L				4/3/2019	

Secondary Effluent and Receiving Water Characterization Data

Location	PTP	Analyte	Qualifier	Result	Units	RL	MDL	Analytical Method	Sample Date	Analysis Date
Secondary Effluent		Ammonia-N	<	ND	mg/L				4/17/2019	
Secondary Effluent		Ammonia-N	<	ND	mg/L				5/1/2019	
Secondary Effluent		Ammonia-N	=	3.2	mg/L				5/15/2019	
Secondary Effluent		Ammonia-N	=	0.39	mg/L				6/23/2019	
Secondary Effluent		Ammonia-N	=	1.6	mg/L				7/17/2019	
Secondary Effluent		Ammonia-N	=	3.1	mg/L				8/7/2019	
Secondary Effluent		Ammonia-N	=	1.4	mg/L				8/21/2019	
Secondary Effluent		Ammonia-N	=	6.6	mg/L				9/4/2019	
Secondary Effluent		Ammonia-N	<	ND	mg/L				9/18/2019	
Secondary Effluent		Ammonia-N	=	2.3	mg/L				10/23/2019	
Secondary Effluent		Ammonia-N	=	1.3	mg/L				11/6/2019	
Secondary Effluent		Ammonia-N	=	0.55	mg/L				11/20/2019	
Secondary Effluent		Ammonia-N	=	0.26	mg/L				12/4/2019	
Secondary Effluent		Ammonia-N	<	ND	mg/L				12/18/2019	
Secondary Effluent		Ammonia-N	=	1.2	mg/L				11/18/2021	
Shay Pond	1	Antimony (Sb)	<	ND	µg/L	6		EPA 200.8	11/17/2021	11/24/2021
Shay Pond	2	Arsenic (As)	<	ND	µg/L	2		EPA 200.8	11/17/2021	11/24/2021
Shay Pond	3	Beryllium (Be)	<	ND	µg/L	1		EPA 200.8	11/17/2021	11/24/2021
Shay Pond	4	Cadmium (Cd)	<	ND	µg/L	1		EPA 200.8	11/17/2021	11/24/2021
Shay Pond	5a	Chromium (+3)	=	0.76	µg/L			[CALC]	11/17/2021	11/24/2021
Shay Pond	5b	Chromium (+6)	=	1	µg/L	1		EPA 218.6	11/17/2021	11/24/2021
Shay Pond	5	Chromium (Total Cr)	J	1.8	µg/L	10		EPA 200.8	11/17/2021	11/24/2021
Shay Pond	6	Copper (Cu)	J	31	µg/L	50		EPA 200.7	11/17/2021	11/23/2021
Shay Pond	7	Lead (Pb)	J	1.4	µg/L	5		EPA 200.8	11/17/2021	11/24/2021
Shay Pond	8	Mercury	<	ND	µg/L	1		EPA 200.8	11/17/2021	11/30/2021
Shay Pond	8	Mercury	<	ND	µg/L	0.2	0.15	EPA 245.1	11/17/2021	11/30/2021
Shay Pond	9	Nickel (Ni)	J	0.52	µg/L	10		EPA 200.8	11/17/2021	11/24/2021
Shay Pond	10	Selenium (Se)	J	1.4	µg/L	5		EPA 200.8	11/17/2021	11/24/2021
Shay Pond	11	Silver (Ag)	<	ND	µg/L	10		EPA 200.8	11/17/2021	11/24/2021
Shay Pond	12	Thallium (Tl)	<	ND	µg/L	1		EPA 200.8	11/17/2021	11/24/2021
Shay Pond	13	Zinc (Zn)	<	ND	µg/L	50		EPA 200.7	11/17/2021	11/23/2021
Shay Pond	14	Cyanide (total)	<	ND	µg/L	50	10	SM4500-CN E	11/17/2021	11/24/2021
Shay Pond	15	Asbestos	<	ND	MFL			EPA 100.2	11/17/2021	11/26/2021
Shay Pond	16	2,3,7,8-TCDD	<	ND	pg/L			EPA 1613B	11/17/2021	12/1/2021
Shay Pond	17	Acrolein	<	ND	µg/L	2	1.2	EPA 624.1	11/17/2021	11/19/2021
Shay Pond	18	Acrylonitrile	<	ND	µg/L	2	0.6	EPA 624.1	11/17/2021	11/19/2021
Shay Pond	19	Benzene	<	ND	µg/L	0.5	0.096	EPA 624.1	11/17/2021	11/19/2021
Shay Pond	20	Bromoform	=	0.58	µg/L	0.5	0.072	EPA 624.1	11/17/2021	11/19/2021

Secondary Effluent and Receiving Water Characterization Data

Location	PTP	Analyte	Qualifier	Result	Units	RL	MDL	Analytical Method	Sample Date	Analysis Date
Shay Pond	21	Carbon tetrachloride	<	ND	µg/L	0.5	0.1	EPA 624.1	11/17/2021	11/19/2021
Shay Pond	22	Chlorobenzene	<	ND	µg/L	0.5	0.088	EPA 624.1	11/17/2021	11/19/2021
Shay Pond	23	Dibromochloromethane	=	0.8	µg/L	0.5	0.052	EPA 624.1	11/17/2021	11/19/2021
Shay Pond	24	Chloroethane	<	ND	µg/L	0.5	0.18	EPA 624.1	11/17/2021	11/19/2021
Shay Pond	25	2-Chloroethylvinyl ether	<	ND	µg/L	1	0.72	EPA 624.1	11/17/2021	11/19/2021
Shay Pond	26	Chloroform	<	ND	µg/L	0.5	0.079	EPA 624.1	11/17/2021	11/19/2021
Shay Pond	27	Bromodichloromethane	J	0.32	µg/L	0.5	0.058	EPA 624.1	11/17/2021	11/19/2021
Shay Pond	28	1,1-Dichloroethane	<	ND	µg/L	0.5	0.08	EPA 624.1	11/17/2021	11/19/2021
Shay Pond	29	1,2-Dichloroethane	<	ND	µg/L	0.5	0.06	EPA 624.1	11/17/2021	11/19/2021
Shay Pond	30	1,1-Dichloroethene	<	ND	µg/L	0.5	0.12	EPA 624.1	11/17/2021	11/19/2021
Shay Pond	31	1,2-Dichloropropane	<	ND	µg/L	0.5	0.066	EPA 624.1	11/17/2021	11/19/2021
Shay Pond	32	1,3-Dichloropropene (total)	<	ND	µg/L	0.5	0.11	EPA 624.1	11/17/2021	11/19/2021
Shay Pond	33	Ethylbenzene	<	ND	µg/L	2	0.098	EPA 624.1	11/17/2021	11/19/2021
Shay Pond	34	Bromomethane	<	ND	µg/L	0.5	0.19	EPA 624.1	11/17/2021	11/19/2021
Shay Pond	35	Chloromethane	<	ND	µg/L	2	0.19	EPA 624.1	11/17/2021	11/19/2021
Shay Pond	36	Methylene chloride	<	ND	µg/L	2	0.076	EPA 624.1	11/17/2021	11/19/2021
Shay Pond	37	1,1,2,2-Tetrachloroethane	<	ND	µg/L	0.5	0.11	EPA 624.1	11/17/2021	11/19/2021
Shay Pond	38	Tetrachloroethene	<	ND	µg/L	0.5	0.11	EPA 624.1	11/17/2021	11/19/2021
Shay Pond	39	Toluene	<	ND	µg/L	2	0.07	EPA 624.1	11/17/2021	11/19/2021
Shay Pond	40	trans-1,2-Dichloroethene	<	ND	µg/L	1	0.11	EPA 624.1	11/17/2021	11/19/2021
Shay Pond	41	1,1,1-Trichloroethane	<	ND	µg/L	0.5	0.06	EPA 624.1	11/17/2021	11/19/2021
Shay Pond	42	1,1,2-Trichloroethane	<	ND	µg/L	0.5	0.068	EPA 624.1	11/17/2021	11/19/2021
Shay Pond	43	Trichloroethene	<	ND	µg/L	2	0.082	EPA 624.1	11/17/2021	11/19/2021
Shay Pond	44	Vinyl chloride	<	ND	µg/L	0.5	0.12	EPA 624.1	11/17/2021	11/19/2021
Shay Pond	45	2-Chlorophenol	<	ND	µg/L	10	2.7	EPA 625	11/17/2021	11/24/2021
Shay Pond	46	2,4-Dichlorophenol	<	ND	µg/L	5	3.5	EPA 625	11/17/2021	11/24/2021
Shay Pond	47	2,4-Dimethylphenol	<	ND	µg/L	10	3	EPA 625	11/17/2021	11/24/2021
Shay Pond	48	4,6-Dinitro-2-methylphenol	<	ND	µg/L	50	3.7	EPA 625	11/17/2021	11/24/2021
Shay Pond	49	2,4-Dinitrophenol	<	ND	µg/L	25	2.6	EPA 625	11/17/2021	11/24/2021
Shay Pond	50	2-Nitrophenol	<	ND	µg/L	50	2.5	EPA 625	11/17/2021	11/24/2021
Shay Pond	51	4-Nitrophenol	<	ND	µg/L	50	2.8	EPA 625	11/17/2021	11/24/2021
Shay Pond	52	4-Chloro-3-methylphenol	<	ND	µg/L	25	3.4	EPA 625	11/17/2021	11/24/2021
Shay Pond	53	Pentachlorophenol	<	ND	µg/L	25	4.9	EPA 625	11/17/2021	11/24/2021
Shay Pond	54	Phenol	<	ND	µg/L	5	2.5	EPA 625	11/17/2021	11/24/2021
Shay Pond	55	2,4,6-Trichlorophenol	<	ND	µg/L	50	3.6	EPA 625	11/17/2021	11/24/2021
Shay Pond	56	Acenaphthene	<	ND	µg/L	0.5	0.27	EPA 610	11/17/2021	11/29/2021
Shay Pond	57	Acenaphthylene	<	ND	µg/L	0.2	0.011	EPA 610	11/17/2021	11/29/2021
Shay Pond	58	Anthracene	<	ND	µg/L	0.2	0.029	EPA 610	11/17/2021	11/29/2021

Secondary Effluent and Receiving Water Characterization Data

Location	PTP	Analyte	Qualifier	Result	Units	RL	MDL	Analytical Method	Sample Date	Analysis Date
Shay Pond	59	Benzidine	<	ND	µg/L	25	2.5	EPA 625	11/17/2021	11/24/2021
Shay Pond	60	Benzo (a) anthracene	<	ND	µg/L	0.2	0.023	EPA 610	11/17/2021	11/29/2021
Shay Pond	61	Benzo (a) pyrene	<	ND	µg/L	0.1	0.03	EPA 610	11/17/2021	11/29/2021
Shay Pond	62	Benzo (b) fluoranthene	<	ND	µg/L	0.5	0.03	EPA 610	11/17/2021	11/29/2021
Shay Pond	63	Benzo (g,h,i) perylene	<	ND	µg/L	0.2	0.029	EPA 610	11/17/2021	11/29/2021
Shay Pond	64	Benzo (k) fluoranthene	<	ND	µg/L	0.2	0.029	EPA 610	11/17/2021	11/29/2021
Shay Pond	65	Bis(2-chloroethoxy)methane	<	ND	µg/L	25	2.8	EPA 625	11/17/2021	11/24/2021
Shay Pond	66	Bis(2-chloroethyl)ether	<	ND	µg/L	5	2.5	EPA 625	11/17/2021	11/24/2021
Shay Pond	67	Bis(2-chloroisopropyl)ether	<	ND	µg/L	50	2.5	EPA 625	11/17/2021	11/24/2021
Shay Pond	68	Bis(2-ethylhexyl)phthalate	<	ND	µg/L	7.5	3.3	EPA 625	11/17/2021	11/24/2021
Shay Pond	69	4-Bromophenyl phenyl ether	<	ND	µg/L	50	2.5	EPA 625	11/17/2021	11/24/2021
Shay Pond	70	Butyl benzyl phthalate	<	ND	µg/L	50	6	EPA 625	11/17/2021	11/24/2021
Shay Pond	71	2-Chloronaphthalene	<	ND	µg/L	50	2.5	EPA 625	11/17/2021	11/24/2021
Shay Pond	72	4-Chlorophenyl phenyl ether	<	ND	µg/L	25	2.5	EPA 625	11/17/2021	11/24/2021
Shay Pond	73	Chrysene	<	ND	µg/L	0.2	0.028	EPA 610	11/17/2021	11/29/2021
Shay Pond	74	Dibenz (a,h) anthracene	<	ND	µg/L	0.1	0.027	EPA 610	11/17/2021	11/29/2021
Shay Pond	75	1,2-Dichlorobenzene	<	ND	µg/L	0.5	0.059	EPA 624.1	11/17/2021	11/19/2021
Shay Pond	76	1,3-Dichlorobenzene	<	ND	µg/L	0.5	0.077	EPA 624.1	11/17/2021	11/19/2021
Shay Pond	77	1,4-Dichlorobenzene	<	ND	µg/L	0.5	0.26	EPA 624.1	11/17/2021	11/19/2021
Shay Pond	78	3,3'-Dichlorobenzidine	<	ND	µg/L	25	2.5	EPA 625	11/17/2021	11/24/2021
Shay Pond	79	Diethyl phthalate	<	ND	µg/L	10	2.7	EPA 625	11/17/2021	11/24/2021
Shay Pond	80	Dimethyl phthalate	<	ND	µg/L	10	5.5	EPA 625	11/17/2021	11/24/2021
Shay Pond	81	Di-n-butyl phthalate	<	ND	µg/L	50	3.7	EPA 625	11/17/2021	11/24/2021
Shay Pond	82	2,4-Dinitrotoluene (2,4-DNT)	<	ND	µg/L	25	3	EPA 625	11/17/2021	11/24/2021
Shay Pond	83	2,6-Dinitrotoluene (2,6-DNT)	<	ND	µg/L	25	3.9	EPA 625	11/17/2021	11/24/2021
Shay Pond	84	Di-n-octyl phthalate	<	ND	µg/L	50	3.6	EPA 625	11/17/2021	11/24/2021
Shay Pond	85	1,2-Diphenylhydrazine	<	ND	µg/L	5	2.5	EPA 625	11/17/2021	11/24/2021
Shay Pond	86	Fluoranthene	<	ND	µg/L	0.2	0.033	EPA 610	11/17/2021	11/29/2021
Shay Pond	87	Fluorene	<	ND	µg/L	0.2	0.15	EPA 610	11/17/2021	11/29/2021
Shay Pond	88	Hexachlorobenzene	<	ND	µg/L	5	2.5	EPA 625	11/17/2021	11/24/2021
Shay Pond	89	Hexachlorobutadiene	<	ND	µg/L	1	0.13	EPA 624.1	11/17/2021	11/19/2021
Shay Pond	90	Hexachlorocyclopentadiene	<	ND	µg/L	25	2.5	EPA 625	11/17/2021	11/24/2021
Shay Pond	91	Hexachloroethane	<	ND	µg/L	5	2.5	EPA 625	11/17/2021	11/24/2021
Shay Pond	92	Indeno (1,2,3-cd) pyrene	<	ND	µg/L	0.05	0.035	EPA 610	11/17/2021	11/29/2021
Shay Pond	93	Isophorone	<	ND	µg/L	5	2.8	EPA 625	11/17/2021	11/24/2021
Shay Pond	94	Naphthalene	<	ND	µg/L	0.2	0.018	EPA 610	11/17/2021	11/29/2021
Shay Pond	94	Naphthalene	<	ND	µg/L	1	0.11	EPA 624.1	11/17/2021	11/19/2021
Shay Pond	95	Nitrobenzene (NB)	<	ND	µg/L	50	2.6	EPA 625	11/17/2021	11/24/2021

Secondary Effluent and Receiving Water Characterization Data

Location	PTP	Analyte	Qualifier	Result	Units	RL	MDL	Analytical Method	Sample Date	Analysis Date
Shay Pond	96	N-Nitrosodimethylamine	<	ND	µg/L	25	2.5	EPA 625	11/17/2021	11/24/2021
Shay Pond	97	N-Nitrosodi-n-propylamine	<	ND	µg/L	25	2.5	EPA 625	11/17/2021	11/24/2021
Shay Pond	98	N-Nitrosodiphenylamine	<	ND	µg/L	5	3.6	EPA 625	11/17/2021	11/24/2021
Shay Pond	99	Phenanthrene	<	ND	µg/L	0.2	0.012	EPA 610	11/17/2021	11/29/2021
Shay Pond	100	Pyrene	<	ND	µg/L	0.2	0.04	EPA 610	11/17/2021	11/29/2021
Shay Pond	101	1,2,4-Trichlorobenzene	<	ND	µg/L	1	0.79	EPA 624.1	11/17/2021	11/19/2021
Shay Pond	102	Aldrin	<	ND	µg/L	0.025	0.008	EPA 608M	11/17/2021	11/24/2021
Shay Pond	103	alpha-BHC	<	ND	µg/L	0.05	0.008	EPA 608M	11/17/2021	11/24/2021
Shay Pond	104	beta-BHC	<	ND	µg/L	0.025	0.009	EPA 608M	11/17/2021	11/24/2021
Shay Pond	105	gamma-BHC (Lindane)	<	ND	µg/L	0.1	0.007	EPA 608M	11/17/2021	11/24/2021
Shay Pond	106	delta-BHC	<	ND	µg/L	0.025	0.007	EPA 608M	11/17/2021	11/24/2021
Shay Pond	107	Chlordane	<	ND	µg/L	0.5	0.17	EPA 608M	11/17/2021	11/24/2021
Shay Pond	108	4,4'-DDT	<	ND	µg/L	0.05	0.005	EPA 608M	11/17/2021	11/24/2021
Shay Pond	109	4,4'-DDE	<	ND	µg/L	0.25	0.01	EPA 608M	11/17/2021	11/24/2021
Shay Pond	110	4,4'-DDD	<	ND	µg/L	0.25	0.05	EPA 608M	11/17/2021	11/24/2021
Shay Pond	111	Dieldrin	<	ND	µg/L	0.05	0.009	EPA 608M	11/17/2021	11/24/2021
Shay Pond	112	Endosulfan I	<	ND	µg/L	0.1	0.008	EPA 608M	11/17/2021	11/24/2021
Shay Pond	113	Endosulfan II	<	ND	µg/L	0.05	0.005	EPA 608M	11/17/2021	11/24/2021
Shay Pond	114	Endosulfan sulfate	<	ND	µg/L	0.05	0.012	EPA 608M	11/17/2021	11/24/2021
Shay Pond	115	Endrin	<	ND	µg/L	0.05	0.01	EPA 608M	11/17/2021	11/24/2021
Shay Pond	116	Endrin aldehyde	<	ND	µg/L	0.05	0.01	EPA 608M	11/17/2021	11/24/2021
Shay Pond	117	Heptachlor	<	ND	µg/L	0.05	0.009	EPA 608M	11/17/2021	11/24/2021
Shay Pond	118	Heptachlor epoxide	<	ND	µg/L	0.05	0.008	EPA 608M	11/17/2021	11/24/2021
Shay Pond	119	Aroclor 1016	<	ND	µg/L	2.5	2.5	EPA 608M	11/17/2021	11/24/2021
Shay Pond	120	Aroclor 1221	<	ND	µg/L	2.5	2.5	EPA 608M	11/17/2021	11/24/2021
Shay Pond	121	Aroclor 1232	<	ND	µg/L	2.5	2.5	EPA 608M	11/17/2021	11/24/2021
Shay Pond	122	Aroclor 1242	<	ND	µg/L	2.5	2.5	EPA 608M	11/17/2021	11/24/2021
Shay Pond	123	Aroclor 1248	<	ND	µg/L	2.5	2.5	EPA 608M	11/17/2021	11/24/2021
Shay Pond	124	Aroclor 1254	<	ND	µg/L	2.5	2.5	EPA 608M	11/17/2021	11/24/2021
Shay Pond	125	Aroclor 1260	<	ND	µg/L	2.5	2.5	EPA 608M	11/17/2021	11/24/2021
Shay Pond	126	Toxaphene	<	ND	µg/L	2.5	0.26	EPA 608M	11/17/2021	11/24/2021
Shay Pond		Specific Conductance (E.C.)	=	450	µmhos/cm	2		SM 2510B	11/17/2021	11/18/2021
Shay Pond		Total Filterable Residue/TDS	=	320	mg/L	5		SM 2540C	11/17/2021	11/29/2021
Shay Pond		Aluminum (Al)	=	120	µg/L	50		EPA 200.7	11/17/2021	11/23/2021
Shay Pond		Iron (Fe)	=	120	µg/L	100		EPA 200.7	11/17/2021	11/23/2021
Shay Pond		Manganese (Mn)	J	6.7	µg/L	20		EPA 200.7	11/17/2021	11/23/2021
Shay Pond		Ammonia as N (NH3-N)	J	0.24	mg/L	0.5		EPA 350.1	11/17/2021	11/30/2021
Shay Pond		Chloride (Cl)	=	7.6	mg/L	1		EPA 300.0	11/17/2021	11/18/2021

Secondary Effluent and Receiving Water Characterization Data

Location	PTP	Analyte	Qualifier	Result	Units	RL	MDL	Analytical Method	Sample Date	Analysis Date
Shay Pond		Fluoride (F)	=	1.2	mg/L	0.1		EPA 300.0	11/17/2021	11/18/2021
Shay Pond		Nitrate as N (NO3-N)	=	1.2	mg/L	0.4		EPA 300.0	11/17/2021	11/18/2021
Shay Pond		Nitrate + Nitrite (as N)	=	1.3	mg/L	0.4		EPA 300.0	11/17/2021	11/18/2021
Shay Pond		Nitrite as N (NO2-N)	<	ND	mg/L	0.4		EPA 300.0	11/17/2021	11/18/2021
Shay Pond		Sulfate (SO4)	=	23	mg/L	0.5		EPA 300.0	11/17/2021	11/18/2021
Shay Pond		MBAS (LAS Mole. Wt 340.0)	<	ND	mg/L	0.1		SM 5540C	11/17/2021	11/18/2021
Shay Pond		Methyl tert-butyl ether	<	ND	µg/L	3	0.069	EPA 624.1	11/17/2021	11/19/2021
Shay Pond		Styrene	<	ND	µg/L	0.5	0.059	EPA 624.1	11/17/2021	11/19/2021
Shay Pond		Trichlorofluoromethane	<	ND	µg/L	5	0.13	EPA 624.1	11/17/2021	11/19/2021
Shay Pond		Xylenes (total)	<	ND	µg/L	0.5	0.26	EPA 624.1	11/17/2021	11/19/2021
Shay Pond		Total Trihalomethanes (THM)	=	1.7	µg/L	0.5	0.22	EPA 624.1	11/17/2021	11/19/2021
Shay Pond		Iron (Fe) Dissolved	<	ND	µg/L	100		EPA 200.7	11/17/2021	11/29/2021
Shay Pond		Manganese (Mn) Dissolved	<	ND	µg/L	20		EPA 200.7	11/17/2021	11/29/2021
Shay Pond		Boron (B)	J	59	µg/L	100		EPA 200.7	11/17/2021	11/23/2021
Shay Pond		Hardness, Total (as CaCO3)	=	180	mg/L	6.6		Calculated	11/17/2021	12/1/2021
Shay Pond		pH (Lab)	=	7.7	SU			SM 4500HB	11/17/2021	11/18/2021
Shay Pond		Temperature (Field)	=	56	°F			Field	11/17/2021	11/17/2021
Shay Pond		Total Kjeldahl Nitrogen	<	ND	mg/L	1		EPA 351.2	11/17/2021	11/22/2021
Shay Pond		Total Nitrogen	=	1.2	mg/L			Calculated	11/17/2021	11/22/2021
Big Bear Lake	1	Antimony (Sb)	J	0.22	µg/L	6		EPA 200.8	12/2/2021	12/9/2021
Big Bear Lake	2	Arsenic (As)	J	1.3	µg/L	2		EPA 200.8	12/2/2021	12/9/2021
Big Bear Lake	3	Beryllium (Be)	<	ND	µg/L	1		EPA 200.8	12/2/2021	12/9/2021
Big Bear Lake	4	Cadmium (Cd)	<	ND	µg/L	1		EPA 200.8	12/2/2021	12/9/2021
Big Bear Lake	5a	Chromium (+3)	J	0.31	µg/L			[CALC]	12/2/2021	12/9/2021
Big Bear Lake	5b	Chromium (+6)	<	ND	µg/L	1		EPA 218.6	12/2/2021	12/3/2021
Big Bear Lake	5	Chromium (Total Cr)	J	0.31	µg/L	10		EPA 200.8	12/2/2021	12/9/2021
Big Bear Lake	6	Copper (Cu)	<	ND	µg/L	50		EPA 200.7	12/2/2021	12/10/2021
Big Bear Lake	7	Lead (Pb)	J	1.8	µg/L	5		EPA 200.8	12/2/2021	12/9/2021
Big Bear Lake	8	Mercury	<	ND	µg/L	1		EPA 200.8	12/2/2021	12/8/2021
Big Bear Lake	8	Mercury	=	0.27	µg/L	0.2	0.15	EPA 245.1	12/2/2021	12/9/2021
Big Bear Lake	9	Nickel (Ni)	<	ND	µg/L	10		EPA 200.8	12/2/2021	12/10/2021
Big Bear Lake	10	Selenium (Se)	<	ND	µg/L	5		EPA 200.8	12/2/2021	12/9/2021
Big Bear Lake	11	Silver (Ag)	J	0.53	µg/L	10		EPA 200.8	12/2/2021	12/9/2021
Big Bear Lake	12	Thallium (Tl)	<	ND	µg/L	1		EPA 200.8	12/2/2021	12/9/2021
Big Bear Lake	13	Zinc (Zn)	<	ND	µg/L	50		EPA 200.7	12/2/2021	12/10/2021
Big Bear Lake	14	Cyanide (total)	<	ND	µg/L	5	1	SM4500-CN E	12/2/2021	12/8/2021
Big Bear Lake	15	Asbestos	<	ND	µg/L	1		EPA 100.2	12/2/2021	12/11/2021
Big Bear Lake	16	2,3,7,8-TCDD	<	ND	pg/L	1.7		EPA 1613B	11/17/2021	12/1/2021

Secondary Effluent and Receiving Water Characterization Data

Location	PTP	Analyte	Qualifier	Result	Units	RL	MDL	Analytical Method	Sample Date	Analysis Date
Big Bear Lake	17	Acrolein	<	ND	µg/L	5	1.2	EPA 624.1	12/15/2021	12/17/2021
Big Bear Lake	18	Acrylonitrile	<	ND	µg/L	2	0.63	EPA 624.1	12/15/2021	12/17/2021
Big Bear Lake	19	Benzene	<	ND	µg/L	1	0.47	EPA 624.1	12/15/2021	12/17/2021
Big Bear Lake	20	Bromoform	<	ND	µg/L	1	0.27	EPA 624.1	12/15/2021	12/17/2021
Big Bear Lake	21	Carbon tetrachloride	<	ND	µg/L	1	0.28	EPA 624.1	12/15/2021	12/17/2021
Big Bear Lake	22	Chlorobenzene	<	ND	µg/L	1	0.35	EPA 624.1	12/15/2021	12/17/2021
Big Bear Lake	23	Dibromochloromethane	<	ND	µg/L	1	0.35	EPA 624.1	12/15/2021	12/17/2021
Big Bear Lake	24	Chloroethane	<	ND	µg/L	1	0.38	EPA 624.1	12/15/2021	12/17/2021
Big Bear Lake	25	2-Chloroethyl vinyl ether	<	ND	µg/L	5	0.19	EPA 624.1	12/15/2021	12/17/2021
Big Bear Lake	26	Chloroform	<	ND	µg/L	1	0.29	EPA 624.1	12/15/2021	12/17/2021
Big Bear Lake	27	Bromodichloromethane	<	ND	µg/L	1	0.44	EPA 624.1	12/15/2021	12/17/2021
Big Bear Lake	28	1,1-Dichloroethane	<	ND	µg/L	1	0.32	EPA 624.1	12/15/2021	12/17/2021
Big Bear Lake	29	1,2-Dichloroethane	<	ND	µg/L	1	0.54	EPA 624.1	12/15/2021	12/17/2021
Big Bear Lake	30	1,1-Dichloroethene	<	ND	µg/L	1	0.32	EPA 624.1	12/15/2021	12/17/2021
Big Bear Lake	31	1,2-Dichloropropane	<	ND	µg/L	1	0.42	EPA 624.1	12/15/2021	12/17/2021
Big Bear Lake	32	1,3-Dichloropropene, Total	<	ND	µg/L	1		EPA 624.1	12/15/2021	12/17/2021
Big Bear Lake	33	Ethylbenzene	<	ND	µg/L	1	0.41	EPA 624.1	12/15/2021	12/17/2021
Big Bear Lake	34	Bromomethane	<	ND	µg/L	1	0.5	EPA 624.1	12/15/2021	12/17/2021
Big Bear Lake	35	Chloromethane	<	ND	µg/L	1	0.29	EPA 624.1	12/15/2021	12/17/2021
Big Bear Lake	36	Methylene chloride	<	ND	µg/L	1	0.39	EPA 624.1	12/15/2021	12/17/2021
Big Bear Lake	37	1,1,2,2-Tetrachloroethane	<	ND	µg/L	1	0.38	EPA 624.1	12/15/2021	12/17/2021
Big Bear Lake	38	Tetrachloroethene	<	ND	µg/L	1	0.34	EPA 624.1	12/15/2021	12/17/2021
Big Bear Lake	39	Toluene	<	ND	µg/L	1	0.36	EPA 624.1	12/15/2021	12/17/2021
Big Bear Lake	40	trans-1,2-Dichloroethene	<	ND	µg/L	1	0.27	EPA 624.1	12/15/2021	12/17/2021
Big Bear Lake	41	1,1,1-Trichloroethane	<	ND	µg/L	1	0.31	EPA 624.1	12/15/2021	12/17/2021
Big Bear Lake	42	1,1,2-Trichloroethane	<	ND	µg/L	1	0.42	EPA 624.1	12/15/2021	12/17/2021
Big Bear Lake	43	Trichloroethene	<	ND	µg/L	1	0.34	EPA 624.1	12/15/2021	12/17/2021
Big Bear Lake	44	Vinyl chloride	<	ND	µg/L	1	0.31	EPA 624.1	12/15/2021	12/17/2021
Big Bear Lake	45	2-Chlorophenol	<	ND	µg/L	2	0.53	EPA 625	12/2/2021	12/9/2021
Big Bear Lake	46	2,4-Dichlorophenol	<	ND	µg/L	1	0.7	EPA 625	12/2/2021	12/9/2021
Big Bear Lake	47	2,4-Dimethylphenol	<	ND	µg/L	2	0.59	EPA 625	12/2/2021	12/9/2021
Big Bear Lake	48	4,6-Dinitro-2-methylphenol	<	ND	µg/L	10	0.74	EPA 625	12/2/2021	12/9/2021
Big Bear Lake	49	2,4-Dinitrophenol	<	ND	µg/L	5	0.51	EPA 625	12/2/2021	12/9/2021
Big Bear Lake	50	2-Nitrophenol	<	ND	µg/L	10	0.5	EPA 625	12/2/2021	12/9/2021
Big Bear Lake	51	4-Nitrophenol	<	ND	µg/L	10	0.55	EPA 625	12/2/2021	12/9/2021
Big Bear Lake	52	4-Chloro-3-methylphenol	<	ND	µg/L	5	0.67	EPA 625	12/2/2021	12/9/2021
Big Bear Lake	53	Pentachlorophenol	<	ND	µg/L	5	0.97	EPA 625	12/2/2021	12/9/2021
Big Bear Lake	54	Phenol	<	ND	µg/L	1	0.5	EPA 625	12/2/2021	12/9/2021

Secondary Effluent and Receiving Water Characterization Data

Location	PTP	Analyte	Qualifier	Result	Units	RL	MDL	Analytical Method	Sample Date	Analysis Date
Big Bear Lake	55	2,4,6-Trichlorophenol	<	ND	µg/L	10	0.71	EPA 625	12/2/2021	12/9/2021
Big Bear Lake	56	Acenaphthene	<	ND	µg/L	0.5	0.27	EPA 610	12/2/2021	12/13/2021
Big Bear Lake	57	Acenaphthylene	<	ND	µg/L	0.2	0.011	EPA 610	12/2/2021	12/13/2021
Big Bear Lake	58	Anthracene	<	ND	µg/L	0.2	0.029	EPA 610	12/2/2021	12/13/2021
Big Bear Lake	59	Benzidine	<	ND	µg/L	5	0.5	EPA 625	12/2/2021	12/9/2021
Big Bear Lake	60	Benzo (a) anthracene	<	ND	µg/L	0.2	0.023	EPA 610	12/2/2021	12/13/2021
Big Bear Lake	61	Benzo (a) pyrene	<	ND	µg/L	0.1	0.03	EPA 610	12/2/2021	12/13/2021
Big Bear Lake	62	Benzo (b) fluoranthene	<	ND	µg/L	0.5	0.03	EPA 610	12/2/2021	12/13/2021
Big Bear Lake	63	Benzo (g,h,i) perylene	<	ND	µg/L	0.2	0.029	EPA 610	12/2/2021	12/13/2021
Big Bear Lake	64	Benzo (k) fluoranthene	<	ND	µg/L	0.2	0.029	EPA 610	12/2/2021	12/13/2021
Big Bear Lake	65	Bis(2-chloroethoxy)methane	<	ND	µg/L	5	0.55	EPA 625	12/2/2021	12/9/2021
Big Bear Lake	66	Bis(2-chloroethyl)ether	<	ND	µg/L	1	0.5	EPA 625	12/2/2021	12/9/2021
Big Bear Lake	67	Bis(2-chloroisopropyl)ether	<	ND	µg/L	10	0.5	EPA 625	12/2/2021	12/9/2021
Big Bear Lake	68	Bis(2-ethylhexyl)phthalate	=	2.6	µg/L	1.5	0.65	EPA 625	12/2/2021	12/9/2021
Big Bear Lake	69	4-Bromophenyl phenyl ether	<	ND	µg/L	10	0.5	EPA 625	12/2/2021	12/9/2021
Big Bear Lake	70	Butyl benzyl phthalate	<	ND	µg/L	10	1.2	EPA 625	12/2/2021	12/9/2021
Big Bear Lake	71	2-Chloronaphthalene	<	ND	µg/L	10	0.5	EPA 625	12/2/2021	12/9/2021
Big Bear Lake	72	4-Chlorophenyl phenyl ether	<	ND	µg/L	5	0.5	EPA 625	12/2/2021	12/9/2021
Big Bear Lake	73	Chrysene	<	ND	µg/L	0.2	0.028	EPA 610	12/2/2021	12/13/2021
Big Bear Lake	74	Dibenz (a,h) anthracene	<	ND	µg/L	0.1	0.027	EPA 610	12/2/2021	12/13/2021
Big Bear Lake	75	o-Dichlorobenzene	<	ND	µg/L	1	0.35	EPA 624.1	12/15/2021	12/17/2021
Big Bear Lake	76	m-Dichlorobenzene	<	ND	µg/L	1	0.39	EPA 624.1	12/15/2021	12/17/2021
Big Bear Lake	77	p-Dichlorobenzene	<	ND	µg/L	1	0.42	EPA 624.1	12/15/2021	12/17/2021
Big Bear Lake	78	3,3'-Dichlorobenzidine	J	2.87	µg/L	5	0.5	EPA 625	12/2/2021	12/9/2021
Big Bear Lake	79	Diethyl phthalate	<	ND	µg/L	2	0.54	EPA 625	12/2/2021	12/9/2021
Big Bear Lake	80	Dimethyl phthalate	<	ND	µg/L	2	1.1	EPA 625	12/2/2021	12/9/2021
Big Bear Lake	81	Di-n-butyl phthalate	<	ND	µg/L	10	0.73	EPA 625	12/2/2021	12/9/2021
Big Bear Lake	82	2,4-Dinitrotoluene (2,4-DNT)	<	ND	µg/L	5	0.59	EPA 625	12/2/2021	12/9/2021
Big Bear Lake	83	2,6-Dinitrotoluene (2,6-DNT)	<	ND	µg/L	5	0.77	EPA 625	12/2/2021	12/9/2021
Big Bear Lake	84	Di-n-octyl phthalate	<	ND	µg/L	10	0.72	EPA 625	12/2/2021	12/9/2021
Big Bear Lake	85	1,2-Diphenylhydrazine	<	ND	µg/L	1	0.5	EPA 625	12/2/2021	12/9/2021
Big Bear Lake	86	Fluoranthene	<	ND	µg/L	0.2	0.033	EPA 610	12/2/2021	12/13/2021
Big Bear Lake	87	Fluorene	<	ND	µg/L	0.2	0.15	EPA 610	12/2/2021	12/13/2021
Big Bear Lake	88	Hexachlorobenzene	<	ND	µg/L	1	0.5	EPA 625	12/2/2021	12/9/2021
Big Bear Lake	90	Hexachlorocyclopentadiene	<	ND	µg/L	5	0.5	EPA 625	12/2/2021	12/9/2021
Big Bear Lake	91	Hexachloroethane	<	ND	µg/L	1	0.5	EPA 625	12/2/2021	12/9/2021
Big Bear Lake	92	Indeno (1,2,3-cd) pyrene	<	ND	µg/L	0.05	0.035	EPA 610	12/2/2021	12/13/2021
Big Bear Lake	93	Isophorone	<	ND	µg/L	1	0.55	EPA 625	12/2/2021	12/9/2021

Secondary Effluent and Receiving Water Characterization Data

Location	PTP	Analyte	Qualifier	Result	Units	RL	MDL	Analytical Method	Sample Date	Analysis Date
Big Bear Lake	94	Naphthalene	<	ND	µg/L	0.2	0.018	EPA 610	12/2/2021	12/13/2021
Big Bear Lake	95	Nitrobenzene (NB)	<	ND	µg/L	10	0.52	EPA 625	12/2/2021	12/9/2021
Big Bear Lake	96	N-Nitrosodimethylamine	<	ND	µg/L	5	0.5	EPA 625	12/2/2021	12/9/2021
Big Bear Lake	97	N-Nitrosodi-n-propylamine	<	ND	µg/L	5	0.5	EPA 625	12/2/2021	12/9/2021
Big Bear Lake	98	N-Nitrosodiphenylamine	<	ND	µg/L	1	0.71	EPA 625	12/2/2021	12/9/2021
Big Bear Lake	99	Phenanthrene	<	ND	µg/L	0.2	0.012	EPA 610	12/2/2021	12/13/2021
Big Bear Lake	100	Pyrene	<	ND	µg/L	0.2	0.04	EPA 610	12/2/2021	12/13/2021
Big Bear Lake	102	Aldrin	<	ND	µg/L	0.005	0.002	EPA 608M	12/2/2021	12/10/2021
Big Bear Lake	103	alpha-BHC	<	ND	µg/L	0.01	0.002	EPA 608M	12/2/2021	12/10/2021
Big Bear Lake	104	beta-BHC	<	ND	µg/L	0.005	0.002	EPA 608M	12/2/2021	12/10/2021
Big Bear Lake	105	gamma-BHC (Lindane)	<	ND	µg/L	0.02	0.001	EPA 608M	12/2/2021	12/10/2021
Big Bear Lake	106	delta-BHC	<	ND	µg/L	0.005	0.001	EPA 608M	12/2/2021	12/10/2021
Big Bear Lake	107	Chlordane	<	ND	µg/L	0.1	0.034	EPA 608M	12/2/2021	12/10/2021
Big Bear Lake	108	4,4'-DDT	<	ND	µg/L	0.01	0.001	EPA 608M	12/2/2021	12/10/2021
Big Bear Lake	109	4,4'-DDE	<	ND	µg/L	0.05	0.002	EPA 608M	12/2/2021	12/10/2021
Big Bear Lake	110	4,4'-DDD	<	ND	µg/L	0.05	0.01	EPA 608M	12/2/2021	12/10/2021
Big Bear Lake	111	Dieldrin	<	ND	µg/L	0.01	0.002	EPA 608M	12/2/2021	12/10/2021
Big Bear Lake	112	Endosulfan I	<	ND	µg/L	0.02	0.002	EPA 608M	12/2/2021	12/10/2021
Big Bear Lake	113	Endosulfan II	<	ND	µg/L	0.01	9E-04	EPA 608M	12/2/2021	12/10/2021
Big Bear Lake	114	Endosulfan sulfate	<	ND	µg/L	0.01	0.002	EPA 608M	12/2/2021	12/10/2021
Big Bear Lake	115	Endrin	<	ND	µg/L	0.01	0.002	EPA 608M	12/2/2021	12/10/2021
Big Bear Lake	116	Endrin aldehyde	<	ND	µg/L	0.01	0.002	EPA 608M	12/2/2021	12/10/2021
Big Bear Lake	117	Heptachlor	<	ND	µg/L	0.01	0.002	EPA 608M	12/2/2021	12/10/2021
Big Bear Lake	118	Heptachlor epoxide	<	ND	µg/L	0.01	0.002	EPA 608M	12/2/2021	12/10/2021
Big Bear Lake	119	Aroclor 1016	<	ND	µg/L	0.5	0.5	EPA 608M	12/2/2021	12/10/2021
Big Bear Lake	120	Aroclor 1221	<	ND	µg/L	0.5	0.5	EPA 608M	12/2/2021	12/10/2021
Big Bear Lake	121	Aroclor 1232	<	ND	µg/L	0.5	0.5	EPA 608M	12/2/2021	12/10/2021
Big Bear Lake	122	Aroclor 1242	<	ND	µg/L	0.5	0.5	EPA 608M	12/2/2021	12/10/2021
Big Bear Lake	123	Aroclor 1248	<	ND	µg/L	0.5	0.5	EPA 608M	12/2/2021	12/10/2021
Big Bear Lake	124	Aroclor 1254	<	ND	µg/L	0.5	0.5	EPA 608M	12/2/2021	12/10/2021
Big Bear Lake	125	Aroclor 1260	<	ND	µg/L	0.5	0.5	EPA 608M	12/2/2021	12/10/2021
Big Bear Lake	126	Toxaphene	<	ND	µg/L	0.5	0.052	EPA 608M	12/2/2021	12/10/2021
Big Bear Lake		Specific Conductance (E.C.)	=	470	µmhos/cm	2		SM 2510B	12/2/2021	12/3/2021
Big Bear Lake		Total Filterable Residue/TDS	=	320	mg/L	5		SM 2540C	12/2/2021	12/10/2021
Big Bear Lake		Aluminum (Al)	=	58	µg/L	50		EPA 200.7	12/2/2021	12/10/2021
Big Bear Lake		Iron (Fe)	J	66	µg/L	100		EPA 200.7	12/2/2021	12/10/2021
Big Bear Lake		Manganese (Mn)	=	29	µg/L	20		EPA 200.7	12/2/2021	12/10/2021
Big Bear Lake		Ammonia as N (NH3-N)	J	0.29	mg/L	0.5		EPA 350.1	12/2/2021	12/16/2021

Secondary Effluent and Receiving Water Characterization Data

Location	PTP Analyte	Qualifier	Result	Units	RL	MDL	Analytical Method	Sample Date	Analysis Date
Big Bear Lake	Chloride (Cl)	=	26	mg/L	1		EPA 300.0	12/2/2021	12/2/2021
Big Bear Lake	Fluoride (F)	=	0.41	mg/L	0.1		EPA 300.0	12/2/2021	12/2/2021
Big Bear Lake	Nitrate as N (NO3-N)	<	ND	mg/L	0.4		EPA 300.0	12/2/2021	12/2/2021
Big Bear Lake	Nitrate + Nitrite (as N)	<	ND	mg/L	0.4		EPA 300.0	12/2/2021	12/2/2021
Big Bear Lake	Nitrite as N (NO2-N)	<	ND	mg/L	0.4		EPA 300.0	12/2/2021	12/2/2021
Big Bear Lake	Sulfate (SO4)	=	18	mg/L	0.5		EPA 300.0	12/2/2021	12/2/2021
Big Bear Lake	MBAS (LAS Mole. Wt 340.0)	J	0.058	mg/L	0.1		SM 5540C	12/2/2021	12/2/2021
Big Bear Lake	Methyl tert-butyl ether (MTBE)	<	ND	µg/L	1	0.4	EPA 624.1	12/15/2021	12/17/2021
Big Bear Lake	Trichlorofluoromethane	<	ND	µg/L	1	0.43	EPA 624.1	12/15/2021	12/17/2021
Big Bear Lake	m,p-Xylene	<	ND	µg/L	1	0.29	EPA 624.1	12/15/2021	12/17/2021
Big Bear Lake	o-Xylene	<	ND	µg/L	1	0.29	EPA 624.1	12/15/2021	12/17/2021
Big Bear Lake	Iron (Fe) Dissolved	<	ND	µg/L	100		EPA 200.7	12/2/2021	12/10/2021
Big Bear Lake	Manganese (Mn) Dissolved	<	ND	µg/L	20		EPA 200.7	12/2/2021	12/10/2021
Big Bear Lake	cis-1,3-Dichloropropene	<	ND	µg/L	1	0.36	EPA 624.1	12/15/2021	12/17/2021
Big Bear Lake	trans-1,3-Dichloropropene	<	ND	µg/L	1	0.33	EPA 624.1	12/15/2021	12/17/2021
Big Bear Lake	Boron (B)	J	54	µg/L	100		EPA 200.7	12/2/2021	12/10/2021
Big Bear Lake	Hardness, Total (as CaCO3)	=	180	mg/L	6.6		Calculated	12/2/2021	12/9/2021
Big Bear Lake	pH (Lab)	=	8.2	SU			SM 4500HB	12/2/2021	12/3/2021
Big Bear Lake	Total Kjeldahl Nitrogen	J	0.87	mg/L	1		EPA 351.2	12/2/2021	12/3/2021
Big Bear Lake	Total Nitrogen	J	0.87	mg/L			Calculated	12/2/2021	12/3/2021

ND = All data were undetected below the MDL.

J = The result is estimated above the MDL and below the RL.

Attachment B.

Approach to Address Big Bear Lake
Nutrient Total Maximum Daily Load in the
NPDES Permit for Big Bear Area Regional
Wastewater Agency

TECH MEMO



REPLENISH
— Big Bear —

Date: 2/28/2022

To: Jayne Joy – Santa Ana Regional Water Quality Control Board,
Executive Officer

CC: David Lawrence – Big Bear Area Regional Wastewater Agency;
Mary Reeves, Big Bear City Community Services District;
Mike Stephenson, Big Bear Municipal Water District;
Reggie Lamson, Big Bear Lake Department of Water and Power

Prepared by: Ashli Desai – Larry Walker Associates (LWA);
Antonia Estevez-Olea, PE - Water Systems Consulting, Inc. (WSC)

Reviewed by: Laine Carlson – WSC;
Rob Morrow – WSC

Project: Replenish Big Bear Program

Subject: Approach to Address Big Bear Lake Nutrient Total Maximum Daily
Load in the NPDES Permit for Big Bear Area Regional Wastewater
Agency

Acknowledgment of Credit

This technical memorandum is financed under the Water Quality, Supply and Infrastructure Improvement Act of 2014, administered by the State of California, Department of Water Resources.



Executive Summary

The Big Bear Area Regional Wastewater Agency (BBARWA) operates an existing regional wastewater treatment plant (WWTP) and related facilities in the Big Bear Valley (Valley). BBARWA has partnered with Big Bear City Community Service District (BBCCSD), Big Bear Lake Department of Water and Power (BBLDWP), Big Bear Municipal Water District (BBMWD), and Bear Valley Basin Groundwater Sustainability Agency (BVBGSA), collectively known as the Agency Team, to develop the Replenish Big Bear Program. The Replenish Big Bear Program is intended to help protect the Valley and the Santa Ana Watershed from the impacts of drought and variable precipitation by recovering a water resource currently discharged outside of the watershed. The program is comprised of several elements; the first project includes treatment upgrades at the BBARWA WWTP to produce disinfected advanced treated effluent by providing tertiary filtration, reverse osmosis (RO) treatment and ultraviolet (UV) disinfection for 100% of the water discharged to Stanfield Marsh Wildlife and Waterfowl Preserve (Stanfield Marsh), a tributary of Big Bear Lake (Lake) and a separate discharge to Shay Pond, a tributary of Shay Creek. These discharges are referred to as the "Lake Discharge" and the "Shay Pond Discharge."

The purpose of this technical memorandum (TM) is to provide a structure for issuing a National Pollutant Discharge Elimination System (NPDES) permit for the BBARWA WWTP to Stanfield Marsh and subsequently to the Lake in the context of the Big Bear Lake Nutrient Total Maximum Daily Load (Nutrient TMDL) for Dry Hydrologic Conditions (Resolution No. R8-2006-0023).

The proposed approach to providing the rationale for permitting the Lake Discharge includes:

- 1) Demonstrating how the Lake Discharge, in conjunction with requirements for other responsible parties in the Nutrient TMDL, will support attaining the numeric targets in the Nutrient TMDL and, by extension, the applicable water quality standards addressed by the TMDL; and
- 2) Identifying total phosphorus (TP) water quality based effluent limitations (WQBELs) that can be assigned to be consistent with the assumptions of the Nutrient TMDL.

To evaluate how the Lake Discharge impacts the attainment of numeric targets in the Lake, the impacts were simulated using a two-dimensional hydrodynamic-water quality model (CE-QUAL-W2) of Big Bear Lake developed by Dr. Michael A. Anderson (2021 Lake Model Analysis) and updated in 2022. The 2021 Lake Model Analysis and 2022 Lake Model Update demonstrated that the Lake Discharge will likely result in lower concentrations of TP and chlorophyll-a as compared to the baseline conditions without the project and will increase Lake levels, reducing the amount of time critical conditions occur in the Lake.

To develop an NPDES permit for the Lake Discharge, TP WQBELs must be developed that are consistent with the assumptions of the Nutrient TMDL. The Nutrient TMDL does not include a TP allocation for the Lake Discharge for dry hydrologic conditions. As a result, to be consistent with the Nutrient TMDL assumptions, the Lake Discharge, in essence, needs to have a zero TP wasteload allocation (WLA) during dry hydrologic conditions and not contribute to exceedances of the numeric targets year-round.

Replenish Big Bear

*Approach to Address Big Bear Lake Nutrient Total Maximum Daily Load in the NPDES Permit for Big Bear Area
Regional Wastewater Agency*

To be consistent with the Nutrient TMDL assumptions, TP WQBELs could be established as a combination of a WQBEL derived from the TP numeric targets and an offset framework that would result in a net zero TP loading (or zero TP WLA) to the Lake. The TP loads added to the Lake by the Lake Discharge will be offset through triennial alum applications to attain net zero TP loadings for the upcoming three years. In the event of extreme runoff (defined here as exceeding about 25,000 acre-feet per year (AFY)¹), which has the potential to bury the reactive alum cap on the sediments and reduce its effectiveness, an alum treatment will be conducted that following spring-summer and the triennial treatment schedule will be reset.

Should the Nutrient TMDL be modified in the future by the Santa Ana Regional Water Quality Control Board (Regional Water Board), allocations for the Lake Discharge could be included and the TP offset program could potentially be discontinued. However, the approach outlined in this TM will provide the justification for issuing an NPDES permit without the need for a TMDL modification.

¹ Approximately the 80th percentile annual inflow based on WaterMaster data for 1977-2018.

Contents

Executive Summary	2
1 Background.....	5
1.1 TMDL Summary.....	5
1.2 Relationship of the Project to the TMDL.....	7
2 Proposed Approach.....	9
2.1 Demonstrating Lake Discharge Will Support Attainment of Nutrient TMDL Numeric Targets.....	10
2.2 Identifying TP WQBELs Consistent with Assumptions of Nutrient TMDL.....	10
3 Demonstration that the Lake Discharge Will Support Attainment of Nutrient TMDL Numeric Targets in the Lake as Compared to Baseline Conditions	11
4 Identifying TP WQBELs Consistent With the Assumptions of the Nutrient TMDL...	16
4.1 Background for Using Offsets in the Context of TMDLs	16
4.2 Rationale for Assigning WQBELs.....	17
4.3 Proposed TP Offset Program.....	18
4.4 Demonstration that Offsets are Aligned with TMDL Requirements.....	19
5 Conclusion.....	22
6 References	23
Attachment A: Legal Authority for Offsets, Pollutant Trading, and Market Programs to Supplement Water Quality Regulation in California’s Impaired Waters Memo2	

1 Background

The purpose of this TM is to provide a structure for issuing an NPDES permit for the BBARWA WWTP discharge to Stanfield Marsh, and subsequently to the Lake in the context of the Nutrient TMDL for Dry Hydrologic Conditions (Resolution No. R8-2006-0023).

1.1 TMDL Summary

The Nutrient TMDL was adopted by the Regional Water Board on April 21, 2006 and became effective on September 25, 2007. Upon adoption, the Nutrient TMDL was incorporated into Section 6 of the Water Quality Control Plan for the Santa Ana Region (Basin Plan). The Nutrient TMDL includes targets for TP, macrophyte coverage, nuisance aquatic vascular plant species, and chlorophyll-a in the Lake (see **Table 1**). The targets are designated as numeric interpretations of Basin Plan water quality objectives. Because the targets are TMDL equivalents of water quality objectives that apply at all times, the targets apply to all hydrologic conditions. However, the loads necessary to meet those numeric targets were only calculated under dry hydrologic conditions, as discussed further below.

Table 1. Nutrient TMDL Numeric Targets

Indicator	Target Value ^{(a)(b)}
TP Concentration ^(c)	Annual average no greater than 35 µg/L
Macrophyte Coverage ^(d)	30-40% on a total lake area basis
Percentage of Nuisance Aquatic Vascular Plant Species ^{(d)(e)}	95% eradication on a total area basis of Eurasian Water milfoil and any other invasive aquatic plant species
Chlorophyll-a Concentration ^(e)	Growing season average no greater than 14 µg/L

Source: Basin Plan

Notes:

- a) Targets to be attained no later than 2015 (dry hydrological conditions), 2020 (all other conditions)
- b) Compliance date for wet and/or average hydrological conditions may change in response to approved TMDLs for wet/average hydrological conditions.
- c) Annual average determined by the following methodology: the nutrient data from both the photic composite and discrete bottom samples are averaged by station number and month; a calendar year average is obtained for each sampling location by averaging the average of each month; and finally, the separate annual averages for each location are averaged to determine the lake-wide average.
- d) Calculated as a 5-yr running average based on measurements taken at peak macrophyte growth.
- e) Growing season is the period from May 1 through October 31 of each year. The chlorophyll-a data from the photic samples are averaged by station number and month; a growing season average is obtained for each sampling location by averaging the average of each month; and finally, the separate growing season averages for each location are averaged to determine the lake-wide average.

Replenish Big Bear

*Approach to Address Big Bear Lake Nutrient Total Maximum Daily Load in the NPDES Permit for Big Bear Area
Regional Wastewater Agency*

As discussed in the Nutrient TMDL, a “weight of evidence” approach will be used to assess attainment of the numeric targets. This means that data pertaining to all targets will be assessed and not attaining one target will not automatically imply that the Lake is not attaining the TMDL (Basin Plan page 6-119).

The Nutrient TMDL also assigns TP WLA to point sources (urban runoff) and load allocations (LA) to non-point sources that were identified as contributing TP loads to the Lake at the time the TMDL was developed. Per the Resolution adopting the Basin Plan Amendment (BPA) that incorporated the Nutrient TMDL into the Basin Plan,

“The TMDL for Dry Hydrological Conditions specifies a reduction in phosphorus from internal nutrient sources, which are lake sediment and macrophytes.... The TMDL for Dry Hydrological Conditions does not specify nutrient reductions from external watershed sources, which include resorts, urban discharges and open space/forested lands.”

Therefore, one of the primary assumptions of the Nutrient TMDL is that the largest sources of TP to the Lake are lake sediment and macrophytes, and external watershed source contributions are minimal compared to those sources. External watershed sources are not required to reduce loads during the dry hydrologic condition (**Table 2**).

The Nutrient TMDL allocations only apply during dry hydrologic conditions, defined as average tributary inflow to the Lake ranging from 0 to 3,049 acre feet (AF), average lake levels ranging from 2,033 to 2,052 meters, and annual precipitation ranging from 0 to 23 inches. The baseline loads, allocations, and responsible parties for achieving the allocations during dry hydrologic conditions are summarized in **Table 2**.

Table 2. Nutrient TMDL WLA and LA for Dry Hydrological Conditions

Source	Baseline Load TP (lbs/yr)	TP Allocation (lbs/yr)	Percent Load Reduction	TMDL Assigned Responsible Parties
WLAs				
Urban	475	475	0%	Department of Transportation (Caltrans), the County of San Bernardino, San Bernardino County Flood Control District, the City of Big Bear Lake
LAs				
Internal Sediment	17,943	8,555	52%	US Forest Service, Caltrans, the County of San Bernardino, San Bernardino County Flood Control District, the City of Big Bear Lake, and Big Bear Mountain Resorts ^a
Internal Macrophyte	21,388	15,700	27%	
Atmospheric Deposition	1,074	1,074	0%	N/A-Background
Forest	175	175	0%	US Forest Service
Resort	33	33	0%	Big Bear Mountain Resorts
Total	41,088	26,012	37%	
Source: Basin Plan				
Notes:				
a) The Nutrient TMDL requires the responsible parties to submit a Lake Management Plan for Big Bear Lake to address the non-point source LAs.				

1.2 Relationship of the Project to the TMDL

The Agency Team is planning the Replenish Big Bear Program, which was developed to help protect the Valley and the Santa Ana Watershed from the impacts of drought and variable precipitation by recovering a water resource currently discharged outside of the watershed. The Replenish Big Bear Program is comprised of three independent projects, which may be implemented separately, when appropriate:

- 1) WWTP upgrades and effluent discharge to Stanfield Marsh (and subsequently to the Lake) and a separate discharge to Shay Pond;
- 2) Use of Lake water for landscape irrigation, construction uses and snowmaking; and
- 3) Use of Lake water for groundwater recharge in Sand Canyon.

The first project includes treatment upgrades at the BBARWA WWTP to produce disinfected advanced treated effluent by providing tertiary filtration, RO treatment and UV disinfection for 100% of the water discharged to the Lake and to Shay Pond. The proposed upgrades to the BBARWA WWTP include:

Replenish Big Bear

Approach to Address Big Bear Lake Nutrient Total Maximum Daily Load in the NPDES Permit for Big Bear Area Regional Wastewater Agency

- Biological nutrient removal improvements to the existing oxidation ditches for improved nitrification and denitrification;
- Tertiary filtration and nitrogen and phosphorus removal via denitrification filters;
- Low- and high-pressure filtration with ultrafiltration (UF) membranes and 90% recovery RO membranes;
- Brine pellet reactor for brine minimization to produce a total system recovery of 99%; and
- UV disinfection.

The proposed upgrades (i.e., new advanced treatment train) would be designed for a treatment capacity of 2.2 million gallons per day (MGD). By 2040, accounting for expected growth, it is estimated that the WWTP could produce 2,210 AFY of advanced treated effluent, assuming a 99% total recovery rate could be achieved (90% RO recovery and 90% recovery of brine through brine minimization). The WWTP currently produces about 2.0 MGD of undisinfected secondary effluent on an average annual basis.

For this TM, the disinfected advanced treated effluent discharge to Stanfield Marsh and subsequently to the Lake is the focus of the analysis. **Table 3** shows the maximum design flow rate and TP concentration and loading for the Lake Discharge. While a portion of the total flow (up to 80 AFY) may be discharged to Shay Pond instead of Stanfield Marsh, this analysis is based on discharging 100% of the treated effluent to Stanfield Marsh to be conservative.

Table 3. Lake Discharge Proposed Max Discharge Flow Rate, TP Concentration and Loading

Parameter	Target Value
Proposed TP Concentration (mg/L)	0.03
Proposed Max Design Flow (MGD)	2.2
Proposed Max TP Discharge Load (lbs/yr)	200

The Lake Discharge will discharge approximately 200 lbs/yr of TP to the Lake, assuming the maximum discharge rate of 2.2 MGD at 0.03 mg/L. As discussed in the Nutrient TMDL Background section, the total loading capacity during dry hydraulic conditions is 26,012 lbs/yr of TP. The Lake Discharge will therefore add less than 1% of the total TP loading capacity to the Lake during dry hydrologic conditions and even less during other hydrologic conditions. In contrast, non-point sources, such as legacy in-lake sediments, contribute the majority of the TP loading to the Lake.

BBARWA WWTP previously held an NPDES permit for discharge to Stanfield Marsh, a tributary to the Lake (Order No. 00-12 NPDES No. CA8000344). In 2004, BBARWA submitted

a Report of Waste Discharge (ROWD) that noted the Stanfield Marsh discharge location was no longer being used and that the WWTP no longer had any discharges to Waters of the United States. Based on the ROWD, in 2005, the NPDES permit was determined to no longer be necessary and was replaced by Waste Discharge Requirements (WDRs) for the Lucerne Valley discharge location (Order R7-2021-0023).

Given that the BBARWA WWTP was not discharging to the Lake or its tributaries at the time of TMDL development, it was not assigned a TP allocation in the Nutrient TMDL. Additionally, the Nutrient TMDL fully assigned the identified TP loading capacity during dry hydrologic conditions to other sources. As a result, under dry hydrologic conditions, no unallocated TP loading capacity is available in the Nutrient TMDL for the BBARWA WWTP to be allocated for the Lake Discharge. Under other hydrologic conditions, the Nutrient TMDL allocations do not apply and loading capacity may be available to assign to the Lake Discharge. As noted in the Nutrient TMDL and in the Staff Report, greater lake volume and dilution is anticipated under wetter conditions.²

As discussed in the Nutrient TMDL, the Regional Water Board intends to revise the Nutrient TMDL in the future to address other hydrologic conditions. When the Nutrient TMDL is revised, TP allocations for the Lake Discharge can be incorporated. However, the Nutrient TMDL modifications may not occur until after the Lake Discharge begins. The purpose of this TM is to provide a structure for issuing an NPDES permit for the Lake Discharge assuming the TMDL has not been revised to incorporate TP allocations for the Lake Discharge prior to NPDES permit issuance.

2 Proposed Approach

When a TMDL exists for a waterbody, the Clean Water Act (CWA) and associated regulations require that the permit contain WQBELs that are “consistent with the assumptions and requirements of any available wasteload allocation for the discharge” (40 Code of Federal Regulations (C.F.R.) § 122.44(d)(1)(vii)(B)). Additionally, United States Code (U.S.C.) § 1313(d)(4)(A) notes that WQBELs associated with a TMDL can be revised if the cumulative effect of all WQBELs will assure attainment of the water quality standard. In general, WQBELs must be “derived from and comply with” all applicable water quality standards. (40 C.F.R. § 122.44(d)(1)(vii)(A).)

The key requirements for the permit are therefore that the WQBELs be consistent with the assumptions of the TMDL and that the cumulative effect of all of the limitations for the sources identified in the TMDL assure attainment of the water quality standards addressed

² “Indeed, since the TMDL for dry hydrological conditions was developed to meet the targets under the critical, worst-case conditions, consistent compliance with these targets is expected to be achieved even in the absence of TMDLs for wet/average hydrological conditions, given the greater lake volume and dilution anticipated under wetter conditions.” (Basin Plan, page 6-119)

by the TMDL. To address these requirements, the proposed approach to providing the rationale for permitting the Lake Discharge includes:

- 1) Demonstrating the Lake Discharge will support attaining the numeric targets in the Nutrient TMDL and by extension the applicable water quality standards addressed by the TMDL; and
- 2) Identifying TP WQBELs that can be assigned to be consistent with the assumptions of the Nutrient TMDL.

2.1 Demonstrating Lake Discharge Will Support Attainment of Nutrient TMDL Numeric Targets

To evaluate how the Lake Discharge could support the attainment of numeric targets in the Lake, the impacts were simulated in the 2021 Lake Model Analysis and a subsequent 2022 Lake Model Update. The relevant results of the modeling are summarized in **Section 4** and the complete results are provided in the reports entitled *Big Bear Lake Analysis: Replenish Big Bear Draft Final Report* (referred to as 2021 Lake Model Analysis; Anderson 2021) and *Replenish Big Bear: Modeling of Higher Flows and with Zero TP Load* (referred to as 2022 Lake Model Update, Anderson, 2022). The 2021 Lake Model Analysis and 2022 Lake Model Update demonstrated that the Lake Discharge will likely result in lower concentrations of TP and chlorophyll-a as compared to the baseline conditions without the project, particularly during dry hydrologic conditions. These reports are included in the Antidegradation

2.2 Identifying TP WQBELs Consistent with Assumptions of Nutrient TMDL

As discussed in the Background section, the Nutrient TMDL does not include a TP allocation for the Lake Discharge for dry hydrologic conditions. As a result, to be consistent with the Nutrient TMDL assumptions, the Lake Discharge in essence needs to have a zero TP WLA during dry hydrologic conditions and not contribute to exceedances of the numeric targets year-round. To be consistent with the Nutrient TMDL assumptions, TP WQBELs could be established as a combination of a TP WQBEL derived from the TMDL numeric targets and an offset framework that would result in a net zero TP loading (or zero TP WLA) to the Lake.

To address the lack of TP allocations in the TMDL during dry hydrologic conditions, the TP loads added to the Lake by the Lake Discharge will be offset through triennial alum applications to attain net zero TP loadings for the upcoming three years. In the event of extreme runoff (defined here as exceeding about 25,000 AFY³), which has the potential to bury the reactive alum cap on the sediments and reduce its effectiveness, an alum

³ Approximately the 80th percentile annual inflow based on WaterMaster data for 1977-2018.

treatment will be conducted that following spring-summer and the triennial treatment schedule will be reset.

Should the TMDL be modified in the future by the Regional Water Board, TP allocations for the Lake Discharge could be included and the offset program could potentially be discontinued. However, the approach outlined above will provide the justification for issuing an NPDES permit without the need for a TMDL modification.

3 Demonstration that the Lake Discharge Will Support Attainment of Nutrient TMDL Numeric Targets in the Lake as Compared to Baseline Conditions

The 2021 Lake Model Analysis was used to evaluate the impact of the Lake Discharge on the Lake as compared to the water quality that would be predicted without the project. The 2021 Lake Model Analysis considered the impact of the Lake Discharge on lake levels, TP, chlorophyll-a and aquatic plants. The 2021 Lake Model Analysis simulated the period 2009 to 2019 with the Lake Discharge as compared to the baseline from that period and predicted future conditions through 2050 for TP and chlorophyll-a. The 2021 Lake Model 2009 to 2019 baseline analysis reflects the impacts of actions taken to date to implement the Nutrient TMDL. The predicted future conditions do not reflect any additional actions that may be taken by the responsible parties to attain the Nutrient TMDL requirements or the impacts of the offset program described above.

For the future model scenarios, the 2021 Lake Model Analysis presented results for three hydrologic conditions 1) 5th -percentile corresponded to an average inflow rate of 8,646 acre feet per year (AFY) and represents extended drought, 2) 50th -percentile (median) corresponded to intervals of both high runoff and drought comparable to 2009-2019 (average annual inflow of 10,595 AFY), and 3) 95th percentile represented a period of protracted above average rainfall and runoff (average annual inflow of 12,225 AFY). The 5th -percentile hydrologic conditions most closely reflect the dry hydrologic conditions determined to be the critical condition for the Nutrient TMDL and are therefore the focus of the discussion.

For the current model scenarios, the 2021 Lake Model Analysis predicted that the Lake Discharge would result in similar or lower TP concentrations in the Lake on average as compared to baseline conditions. For the time period 2009-2019, the 2021 Lake Model Analysis predicted that the Lake Discharge would result in concentrations similar to or lower than the chlorophyll-a concentrations and aquatic plants under the baseline conditions on average (see **Table 4**).⁴

⁴ See 2021 Lake Model Analysis Report (**Attachment A**) pages 47, 48, 56, 58, 59 and 60 for more detailed discussion of the results. The presented results correspond with Alternative 3 in the 2021 Lake Model Analysis. Note that the 2021 Lake Model Analysis Report presents chlorophyll-a values as average annual, which are lower than the growing season average due to the inclusion of winter values.

Table 4. Average Annual Predicted Concentrations of TP, Chlorophyll-a and Plants for 2009-2019 Period under Baseline Scenario and with Replenish Big Bear Project.

Scenario	TP (mg/L)	Chlorophyll-a (µg/L) ^a	Plants (g/m ²)
Baseline (without Project)	0.037	9.3	106.9
With Replenish Big Bear Project	0.035	7.1	103.1

For the future long term scenarios, the 2021 Lake Model Analysis predicted the Lake Discharge would result in similar to or slightly lower TP and chlorophyll-a concentrations for the 5th-percentile hydrologic condition as compared to simulations without the Lake Discharge (aquatic plants were not evaluated in the future model scenarios) (see **Table 5**).⁵

Table 5. Long-Term Median Predicted Concentrations of TP and Chlorophyll-a for 5th-Percentile (Extreme Drought) Hydrologic Condition under the Baseline Scenario and with the Replenish Big Bear Project (TP Expressed as Annual Average Concentrations; Chlorophyll-a Shown as Growing Season Average Concentrations).

Scenario	TP (mg/L)	Chlorophyll-a (µg/L) ^a
Baseline (without Project)	0.055	14.2
With Replenish Big Bear Project	0.046	11.3

Notes:

- a) The 2021 Lake Model Analysis Report presents chlorophyll-a values as annual average, which is lower than the growing season average due to the inclusion of winter values. The data shown in this table was extracted from the 2021 Lake Model Analysis results to represent the growing season average only. Growing season is the period from May 1 through October 31 of each year.

After the development of the 2021 Lake Model Analysis, additional scenarios were completed in 2022 to investigate the impacts of a higher discharge volume, account for WWTP discharge seasonal variability, and assess the impacts of a TP Offset Program on

⁵ Under other hydrologic conditions, the Lake Model predicted that the median concentrations of TP would be similar to or lower than the baseline condition, but that chlorophyll-a concentrations may be slightly higher than the baseline condition with the Project. However, the predicted median chlorophyll-a concentrations under these conditions would be lower than the numeric TMDL target. Further analysis was conducted to evaluate these results (see **Table 7**).

the attainment of the Nutrient TMDL numeric targets. The TP Offset Program results are discussed in **Section 4**.

Recent engineering work indicates that higher discharge flows, up to 2,210 AFY, can be attained by employing additional brine minimization technology (**Table 1**). Note that the 2021 Lake Model Analysis assumed steady annual flows of 1,920 AFY, as it excluded the 80 AFY that could be discharged to Shay Pond. For the 2022 Lake Model Update, to be conservative, the additional analysis assumed all of the disinfected advanced treated effluent produced is discharged to the Lake.

Table 6. Initial and Updated Lake Discharge Flow Projections

Scenario	Lake Discharge Inflow (AFY)	Daily Lake Discharge Inflow (MGD)
Baseline	0	0
2021 Lake Model Analysis – Alternative 3 ^(a)	1920	1.71
2022 Update High Flow (99% recovery) ^(b)	2210	1.57 – 2.18
2022 Update Mid Flow (90% recovery) ^(b)	2009	1.42 – 1.98
Notes:		
a) The total Replenish Big Bear production in the 2021 Lake Model Analysis was assumed to be 2,000 AFY with 80 AFY going to Shay Pond.		
b) The 2022 Lake Model Update was based on all of the advanced treated effluent being discharged to the Lake under two different total recovery rate scenarios, with no discharge to Shay Pond.		

Moreover, deliveries are expected to vary seasonally (**Figure 1**), thus varying from the 2021 Lake Model Analysis that assumed a uniform Lake Discharge of 1.71 MGD throughout the year. Inflows to BBAWRA are lower in the summer months due to reduced inflow and infiltration.

Replenish Big Bear

Approach to Address Big Bear Lake Nutrient Total Maximum Daily Load in the NPDES Permit for Big Bear Area Regional Wastewater Agency

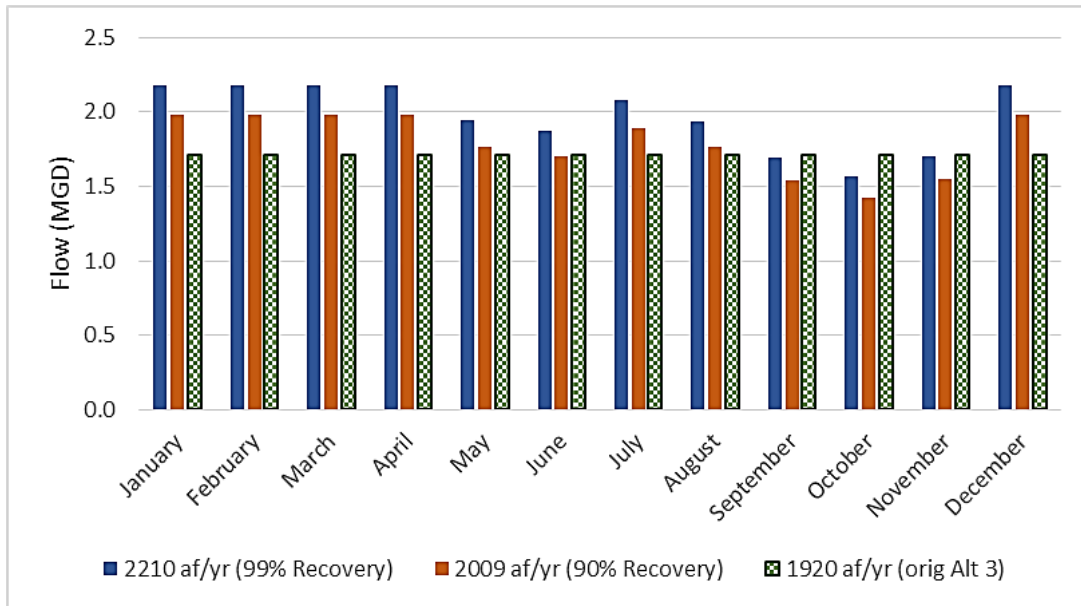

Figure 1. Monthly Flow Rates (Projected 2040) for Replenish Big Bear under Three Project Inflow Scenarios.

The 50th percentile hydrologic scenario for 2009-2050 was used in the additional analysis, noting that it includes a wide array of runoff conditions, including extended drought and periods of high runoff and was predicted to have slightly higher chlorophyll-a concentrations in the 2021 Lake Model Analysis. All other hydrologic, meteorological, biological, chemical and sedimentological factors, variables and conditions were identical to those used in prior simulations of long-term future conditions (Anderson, 2021)⁶.

Long-term average predicted concentrations of TP and chlorophyll-a were lower with the Lake Discharge compared with predicted baseline conditions (**Table 7**). Baseline conditions were predicted to yield growing-season average chlorophyll-a concentration that slightly exceeded (by 0.1 µg/L) the TMDL target value of 14 µg/L, the 2021 Lake Model Analysis matched the target, and larger Lake Discharges that varied seasonally (**Figure 1**) yielded values below baseline and TMDL target values (**Table 7**).

⁶ Anderson, M.A. 2021. *Big Bear Lake Analysis: Replenish Big Bear*. Final Report. 65 pp.

Table 7. Long-Term Average Predicted Concentrations of TP and Chlorophyll-a in Big Bear Lake under Different Operational Scenarios (TP Expressed as Annual Average Concentrations; Chlorophyll-a Shown as Growing Season Average Concentrations)

Operational Scenario (all at 50 th percentile hydrology)	TP (mg/L)	Chlorophyll-a (µg/L)
TMDL target	0.035	14.0
Baseline	0.0477	14.1
1920 AFY (2021 Lake Model Analysis)	0.0433	14.0
2210 AF (99% recovery)	0.04.3	13.1
2009 AF (90% recovery)	0.0434	12.9

Based on the analysis provided by the 2021 Lake Model Analysis and the 2022 Lake Model Update, the Lake Discharge appears likely to improve water quality and increase the amount of time that the Lake would be meeting the water quality targets. In particular, the Lake Discharge is predicted to improve water quality during the dry hydrologic conditions that were determined to be the critical conditions for the TMDL.

Additionally, the 2021 Lake Model Analysis determined that the Lake Discharge would increase Lake levels by an average of two meters and significantly increase the lake volume. This increase results in the Lake levels being higher than the lake levels associated with the TMDL dry hydrologic condition (2,033 to 2,052 m) over 50% of the time during the model conditions associated with drought conditions and rarely falling below 2,052 m during other hydrologic conditions. In contrast, without the project, the Lake levels would be associated with the TMDL dry hydrologic condition approximately 85% of the time during extended drought conditions and between 20 and 45% of the time during other hydrologic conditions (see **Figure 2**). As noted in the Nutrient TMDL, the dry hydrologic conditions are considered to be the critical conditions for the Lake. The Lake Discharge will therefore also support attainment of the numeric targets by reducing the amount of time the critical conditions occur in the Lake.

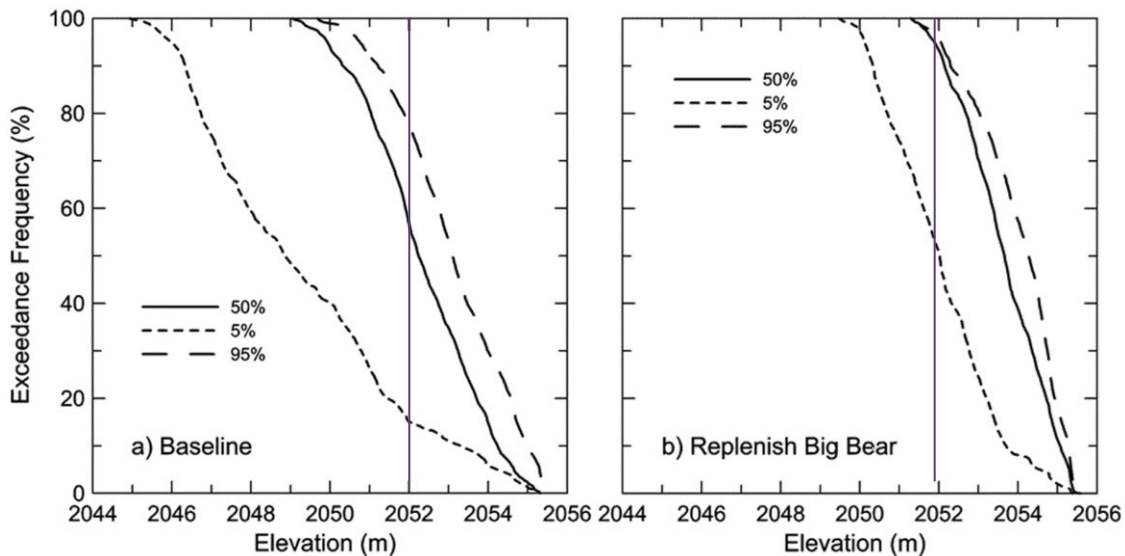

Figure 2. Predicted Lake Elevations at 5th-, 50th- and 95th Percentile Hydrologic Scenarios for a) Baseline Conditions and b) with the Lake Discharge. Vertical Lines Represent Upper Boundary for Lake Level under “Dry Hydrologic Condition”.

4 Identifying TP WQBELs Consistent With the Assumptions of the Nutrient TMDL

Given that the Lake Discharge is predicted to improve conditions in the Lake, it is possible to determine an approach to assigning WQBELs without modifying the TMDL. The proposed approach is to include TP WQBELs consistent with the Nutrient TMDL TP numeric target and a TP offset framework. The TP offset framework will reduce TP loads by an amount equal to the Lake Discharge TP load, thereby resulting in a “net zero” TP load discharged to the Lake. This section describes the rationale for the approach to setting the TP WQBELs and the proposed offset program.

4.1 Background for Using Offsets in the Context of TMDLs

In 2005, the State Water Board developed “A Process for Addressing Impaired Waters in California” (Impaired Waters Policy). Appendix B to the Impaired Waters Policy compiled legal memorandums relevant to TMDLs. One of the memorandums is entitled “Legal Authority for Offsets, Pollutant Trading, and Market Programs to Supplement Water Quality Regulation in California’s Impaired Waters” (State Water Board Offset Memo – see **Attachment A**) and provides a comprehensive discussion of the basis for establishing offsets in NPDES permits for waters that have TMDLs. While the memo was developed in 2001, the fundamental authorities remain and can be applied to permitting the Lake Discharge.

As noted in the State Water Board Offset Memo,

“When a TMDL is in place, the Clean Water Act (CWA) and California law give wide latitude to develop creative means of achieving compliance with water quality standards (WQS), subject to certain limitations.”

“Specifically, if the water is impaired, existing WQBELs may be relaxed if “the cumulative effect of all such revised effluent limitations based on such [TMDL] or waste load allocation will assure attainment of such [WQS].” (33 U.S.C. § 1313(d)(4)(A).)”

“Federal regulations bolster these provisions. Under the regulations, WQBELs must be “consistent with the assumptions and requirements of any available wasteload allocation” (40 C.F.R. § 122.44(d)(1)(vii)(B).) The regulations do not require WQBELs to be “equivalent to” available waste load allocations. Accordingly, so long as the cumulative effect of all WQBELs assures attainment of WQS, hence the assumptions of the TMDL, WQBELs can be adjusted based upon whatever mechanisms the state determines is appropriate.”

The rationale outlined in the State Water Board Offset Memo for allowing offsets in the context of a TMDL is as follows:

- 1) Per Federal regulations implementing the CWA, WQBELs to implement a TMDL do not have to be equivalent to the available WLA as long as they are consistent with the assumptions in the TMDL.
- 2) As long as the cumulative effect of all effluent limitations assures attainment of water quality standards, the WQBELs can be calculated in any way the Regional Water Board determines to be appropriate.

Using offsets is an appropriate method for developing WQBELs for TP for the Lake Discharge because the result would be consistent with the assumptions of the Nutrient TMDL, as further described below.

4.2 Rationale for Assigning WQBELs

The Nutrient TMDL establishes a causal numeric target for TP of 0.035 mg/L as an annual average. As required by the CWA, TMDL numeric targets should be set at levels that will result in protection of beneficial uses and attainment of water quality standards. The Lake Discharge is currently anticipated to have an average discharge concentration of 0.03 mg/L TP, which is below the TMDL numeric target. Therefore, the proposed Lake Discharge quality would be consistent with attaining the numeric target and therefore the water quality standards. Additionally, as discussed in **Section 3**, modeling indicates the Lake Discharge will likely improve TP and chlorophyll-a concentrations in the Lake. The Lake Discharge would therefore be able meet one of the key requirements for attaining a permit by being able to “comply with” applicable water quality standards associated with the TMDL. (40 C.F.R. § 122.44(d)(1)(vii)(A)).

However, as noted in the Nutrient TMDL Background discussion, even though the discharge quality is projected to be below the TP numeric target, the Nutrient TMDL did not include a WLA for the Lake Discharge. As a result, to be consistent with the Nutrient TMDL assumptions, the Lake Discharge in essence needs to have a zero TP WLA during dry hydrologic conditions. Including requirements in the NPDES permit to implement

actions that will offset the TP loads entering the Lake would be equivalent to assigning a zero WLA. The combination of WQBELs calculated based on the TMDL numeric target and offsets would be consistent with the Nutrient TMDL assumptions and support attainment of the water quality standards. While the Nutrient TMDL WLA only applies during dry hydrologic conditions, the Agency Team proposes to conduct TP offsets during all hydrologic conditions to simplify implementation and tracking and to provide a more conservative approach.

The remainder of this section discusses the proposed offsets and how they align with the structure outlined above.

4.3 Proposed TP Offset Program

As part of the Replenish Big Bear Program, the Agency Team is proposing to offset the TP loads introduced by the Lake Discharge to attain a net zero TP loading to be consistent with the Nutrient TMDL WLA assumptions and to apply these offsets during all hydrologic conditions. The proposed TP offset strategy is to proactively apply alum every three years to offset the estimated TP load for the upcoming three years (estimated up to 200 lbs/yr or 600 lbs TP). In the event of extreme runoff (defined here as exceeding about 25,000 AFY), which has the potential to bury the reactive alum cap on the sediments and reduce its effectiveness, an alum treatment will be conducted that following spring-summer and the triennial treatment schedule will be reset. This approach will provide reliable TP load offsets.

In general, alum is a compound used to bind to reactive available phosphorus in the water column, flocculate particulate phosphorus, and reduce internal phosphorus loading from lakebed sediments. After the alum binds to the phosphorus it becomes aluminum phosphate, an inert crystalline compound which renders the phosphorus unavailable to plants and algae as a nutrient. Algae and plants require nitrogen and phosphorus to grow. Since the lake is phosphorus limited, removing phosphorus helps reduce the potential for algae blooms in the summer and slows the growth of aquatic plants in the lake. After the alum sinks to the bottom of the lake, it settles and creates a reactive floc layer which can cap the lakebed sediments and prevent the phosphorus therein from mobilizing out of the sediment and into the water column. Alum treatments often last up to ten years before sorption capacity is exhausted and reapplication is needed.

In 2004, BBMWD, in collaboration with the State Water Board, applied 700,850 gallons of alum across 1,500 surface acres to sequester phosphorus and aid in controlling chlorophyll-a. The estimated TP sequestered from this project was 17,170 lbs per the TMDL annual reports. The application had a significant immediate impact on sequestering phosphorus.

In 2015, BBMWD, in collaboration with the Nutrient TMDL stakeholders, applied 574,832 gallons of alum over 20 days in May and June of that year. Phosphorous concentrations in the lake were elevated at the time due to years of drought and external and internal nutrient loading. The treatment was limited to 420 acres at the western end of the lake where the highest concentrations of phosphorus were found. The estimated TP sequestered from this project was 14,100 lbs per the TMDL annual reports.

As done in 2015, the initial alum application for the TP Offset Program will target the phosphorus-rich organic sediments in the western end of the Lake, where highest dissolved (hypolimnetic) phosphorus and highest sediment phosphorus flux rates are found. Since the objective of these alum applications is to offset a very modest TP loading from the Lake Discharge, rather than substantially reduce internal TP loading and favorably alter the overall TP budget of the lake (which is on the order of 26,000 lbs/yr), it should be noted that marked quantifiable improvements in water quality would not be expected solely as a result of the offset program, especially given the natural variability in hydrology and water quality in the lake. It is anticipated that BBMWD, as the Lake manager, will lead the implementation of the TP Offset Program on behalf of the partner agencies.

4.4 Demonstration that Offsets are Aligned with TMDL Requirements

To evaluate the potential impact of the offsets, further modeling was conducted to evaluate predicted water quality with the TP offset for comparison with the baseline condition and project scenarios without the TP offset. Given the complexity of nutrient budgets of lakes and equivalence of a given form of nutrient irrespective of its particular origin, TP offset was modeled as equivalent to a Lake Discharge with a concentration of 0 mg/L TP. This is an approximation that holds when considering the whole-lake nutrient budget but is nonetheless a simplification; depending upon details of offset, hydrodynamic considerations and other factors, some modest lateral gradients in water quality may result.

Zeroing out the load of TP in the Lake Discharge yielded further reductions in chlorophyll-a. Larger total inflow volumes with reduced summer flows and no net TP loading were predicted to yield growing season average chlorophyll-a concentrations as low as 9.5 - 10.2 µg/L, significantly below predicted baseline and TMDL concentrations (**Table 8**).

Table 8. Long-Term Average Predicted Concentrations of TP and Chlorophyll-a in Big Bear Lake with TP Offset (TP Expressed as Annual Average Concentrations; Chlorophyll-a Shown as Growing Season Average Concentrations)

Operational Scenario (all at 50 th % hydrology)	TP (mg/L)	Chlorophyll-a (µg/L)
TMDL target	0.0350	14.0
Baseline	0.0477	14.1
1920 AFY (2021 Lake Model Analysis)	0.0433	14.0
2210 AFY (99% recovery)	0.0423	13.1
2009 AFY (90% recovery)	0.0434	12.9
2210 AFY + offset TP	0.0399	10.2
2009 AFY + offset TP	0.0409	9.5

While it is important to recognize the uncertainty in model predictions, it is nonetheless noteworthy that the simulation of the TP offset yielded average chlorophyll-a concentrations significantly below baseline and Nutrient TMDL target values. Predicted long-term average TP concentrations remained above the Nutrient TMDL target but were nonetheless meaningfully lower than the predicted baseline level (**Table 8**). Inter-annual differences in water quality are also expected to persist. Cumulative distribution functions (CDFs) highlight the predicted wide range in annual and growing season average concentrations (**Figure 3**). The Lake Discharge resulted in lower annual average TP and growing season average chlorophyll-a concentrations than Baseline under all conditions (**Figure 3**).

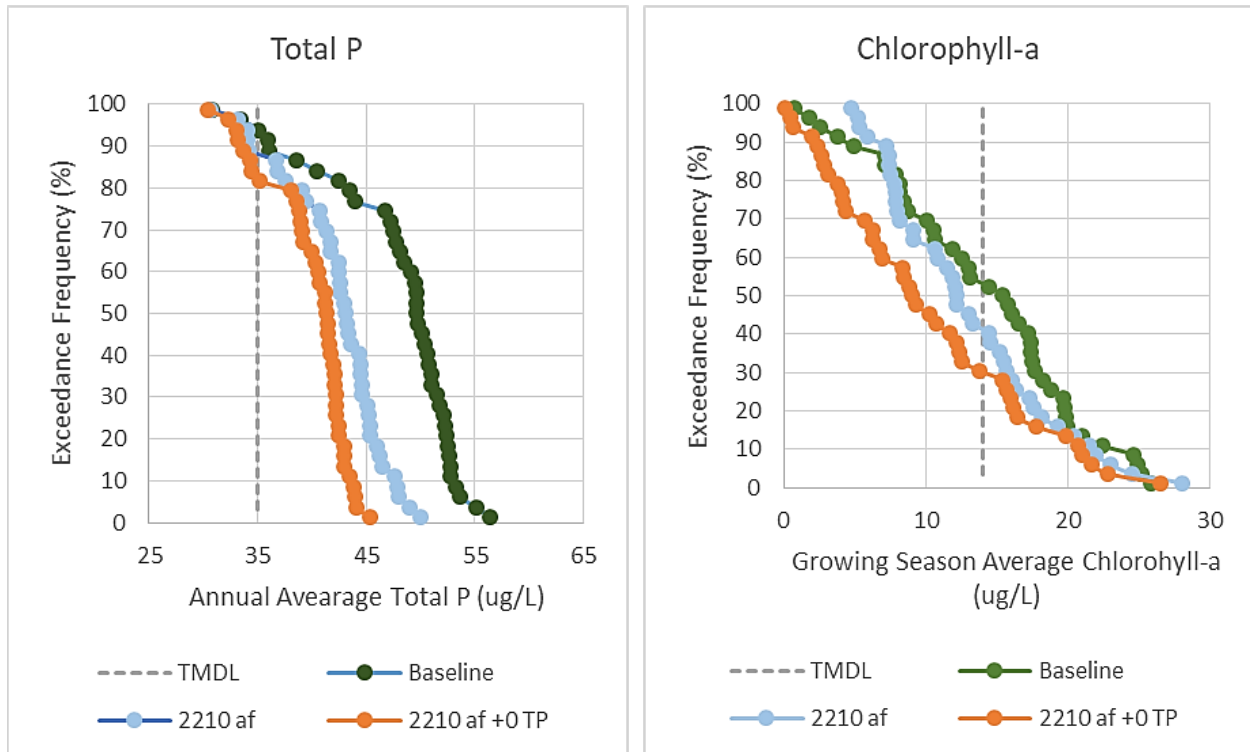

Figure 3. Cumulative Distribution Functions for Predicted Annual TP and Growing Season Average Chlorophyll-a Concentrations for Baseline Condition and with 2,210 AFY Lake Discharge with and without TP Offset.

The model predicted Baseline exceedance frequencies are similar to the observed annual exceedance frequencies based on the TMDL Annual Reports both TP and chlorophyll-a (**Table 9**)

Table 9. Predicted frequency of exceeding TMDL target under baseline conditions and different RBB inflow and TP offset scenarios (annual average or growing season average basis). Observed annual exceedance frequencies for 2009-19 period from TMDL Annual Reports shown in parentheses under Baseline.

Variable	Baseline	2210 AF	2210 AF + 0 TP
TP	94 % (100%)	87 %	82 %
Chlorophyll-a	53 % (55%)	41 %	31 %

As discussed above, the Lake Discharge contributes a minimal amount of loading compared to the other sources described in the Nutrient TMDL. Therefore, the Lake Discharge in and of itself does not need to result in attainment of the water quality standards. Rather, the Lake Discharge, in combination with the other efforts required by the Nutrient TMDL should result in attainment of the water quality standards. The 2021 Lake Model Analysis demonstrates that the Lake Discharge will likely contribute to more

frequent attainment of the Nutrient TMDL numeric targets and associated water quality standards, especially when combined with the offset program and actions taken by the TMDL responsible parties to attain the Nutrient TMDL requirements. Additionally, the Lake Discharge will increase Lake levels, which will contribute to protection of other beneficial uses and reduce the amount of time critical hydrologic conditions occur in the Lake.

5 Conclusion

In conclusion, permitting the Lake Discharge in the context of the existing Nutrient TMDL can be accomplished by:

- 1) Establishing TP WQBELs that are consistent with the Nutrient TMDL assumptions; and
- 2) Making permit findings that the WQBELs are derived from and comply with water quality standards.

The TP WQBELs that are based on the Nutrient TMDL numeric targets and include requirements to implement the offset strategies outlined in this TM would be consistent with the Nutrient TMDL numeric targets and the assumptions of the Nutrient TMDL allocations. Additionally, because the Nutrient TMDL numeric targets were established to meet water quality standards, WQBELs based on the Nutrient TMDL numeric targets would be derived from and comply with water quality standards. Finally, the 2021 Lake Model Analysis and subsequent additional model analysis results can be used to demonstrate that the Lake Discharge will provide benefits to beneficial uses and likely help improve water quality in the Lake.

In the future, if the Nutrient TMDL is revised, allocations can be assigned to the Lake Discharge. Then permit conditions could be revised (e.g., removing the offset framework), if appropriate to reflect the TMDL allocations.

6 References

Anderson, M.A. 2021. *Big Bear Lake Analysis: Replenish Big Bear*. Final Report.

Anderson, M.A. 2022. *Replenish Big Bear: Modeling of Higher Flows and with Zero TP Load*. Final Report.

Santa Ana Regional Water Quality Control Board. *Water Quality Control Plan (Basin Plan) for the Santa Ana River Basin*. Updated June 2019.

California State Water Board. 2001. *Legal Authority for Offsets, Pollutant Trading, and Market Programs to Supplement Water Quality Regulation in California's Impaired Waters*.

Replenish Big Bear

*Approach to Address Big Bear Lake Nutrient Total Maximum Daily Load in the NPDES Permit for Big Bear Area
Regional Wastewater Agency*

Attachment A: Legal Authority for Offsets, Pollutant Trading, and Market Programs to Supplement Water Quality Regulation in California's Impaired Waters Memo



Winston H. Hickox
Secretary for
Environmental
Protection

State Water Resources Control Board

Office of Chief Counsel

1001 I Street, 22nd Floor, Sacramento, California 95814
P.O. Box 100, Sacramento, California 95812-0100
(916) 341-5161 ♦ FAX (916) 341-5199 ♦ www.swrcb.ca.gov



Gray Davis
Governor

The energy challenge facing California is real. Every Californian needs to take immediate action to reduce energy consumption. For a list of simple ways you can reduce demand and cut your energy costs, see our website at www.swrcb.ca.gov.

TO: Arthur G. Baggett, Jr.
Chair

/ s /

FROM: Craig M. Wilson
Chief Counsel
OFFICE OF CHIEF COUNSEL

DATE: October 16, 2001

SUBJECT: LEGAL AUTHORITY FOR OFFSETS, POLLUTANT TRADING, AND
MARKET PROGRAMS TO SUPPLEMENT WATER QUALITY
REGULATION IN CALIFORNIA'S IMPAIRED WATERS

I. Introduction

This memorandum has been prepared to outline the existing legal authority to employ offsets, pollutant trading, and other market programs to supplement water quality regulation in impaired waters. While there is no fixed definition of these terms, "offsets" generally refer to unilateral abatement efforts by a discharger to remove a certain amount of pollutant discharge from existing sources to compensate for the discharger's own discharge. "Pollutant trading" generally refers to an exchange of either permitted discharge levels or required abatement levels between two or more dischargers, either in a formal "commodities" market or banking system, or a less structured exchange.

In sum, the extent to which such mechanisms may be employed varies greatly depending upon whether a TMDL has been adopted for the impaired water, although they may be permissible in either context. The analysis in this memorandum is equally applicable for any market-type mechanism, be it offsets, pollutant trading, or another analogous system that would authorize one discharger to perform (or to encourage another to perform) additional abatement or restoration in lieu of meeting an otherwise applicable or more stringent discharge limitation or prohibition.

This memorandum should not be construed as delineating the universe of possible market-scenarios that may be legal in given circumstances. Each such system must be evaluated in the context of its own circumstance. However, this document is intended to discuss some of the legal issues that will arise in considering such systems. These include at least the anti-

backsliding rule, and the extent to which the regulations authorize new or renewed permits to be issued for discharges into impaired waters.

In considering any of these approaches, Regional Water Quality Control Boards (Regional Boards) should be cognizant of the state's legal obligation to adopt and implement approximately 1400 TMDLs. Accordingly, any market system should only be contemplated under circumstances that will promote (and not forestall) TMDL development or attainment of water quality standards.

II. Irrespective of whether a TMDL exists, federal law requires each point source to be subject to applicable technology based effluent limitations (TBELs) as a floor.

Section 402(b) of the CWA requires that all NPDES permits issued by California contain applicable TBELs. (33 U.S.C. § 1342(b)(1)(A). See also 33 U.S.C. §§ 1311, 1313(e)(3)(A).) Effluent limitations based upon the best available technology are the floor and the minimum that must be required of any NPDES permitted discharge. Thus, no market system can be adopted that would afford relief from TBELs in NPDES permits, for either new or existing sources.

III. When a TMDL is in place, the Clean Water Act (CWA) and California law give wide latitude to develop creative means of achieving compliance with water quality standards (WQS), subject to certain limitations.

A. The water quality based effluent limitations (WQBELs) applicable to new or existing point sources can be adjusted in compliance with a TMDL.

NPDES permits must also incorporate “any requirements in addition to or more stringent than [TBELs] necessary to . . . [a]chieve water quality standards.” (44 C.F.R. § 122.44(d)(1).) See also 33 USC §§ 1342(b), 1311(b)(1)(C).) Unlike TBELs, these water quality based effluent limitations (WQBELs) can be adjusted in contemplation of a TMDL. While the CWA's anti-backsliding provisions would ordinarily prohibit the state from permitting a less stringent effluent limitation, section 402(o) contains an express exception applicable when a TMDL is in place. (33 U.S.C. § 1342(o).) Specifically, if the water is impaired, existing WQBELs may be relaxed if “the cumulative effect of all such revised effluent limitations based on such [TMDL] or waste load allocation will assure attainment of such [WQS].” (33 U.S.C. § 1313(d)(4)(A).)

Federal regulations bolster these provisions. Under the regulations, WQBELs must be “consistent with the assumptions and requirements of any available wasteload allocation” (40 C.F.R. § 122.44(d)(1)(vii)(B).) The regulations do not require WQBELs to be “equivalent to” available waste load allocations. Accordingly, so long as the cumulative effect of all WQBELs assures attainment of WQS, hence the assumptions of the TMDL, WQBELs can be adjusted based upon whatever mechanisms the state determines is appropriate.

This regulatory structure is equally applicable to new sources. A WQBEL that otherwise would be applicable to a new source can also be adjusted based upon a TMDL, whether through the use of offsets or other appropriate measures, that insure attainment of WQS. The CWA's anti-backsliding provisions do not apply to new dischargers.

To avoid a claim that a given NPDES permit is inconsistent with a TMDL, if any such mechanisms are contemplated, it would be appropriate to incorporate pertinent details of the market-based provisions into the TMDL implementation plan. If sufficient details of potential market approaches are not known at the time the implementation plan is adopted, alternatively, Regional Boards can retain flexibility in translating WLAs into effluent limitations by articulating a provision similar to the following in the implementation plan:

“While individual WQBELs shall be consistent with the assumptions and requirements of the available WLAs, LAs, and the TMDL, individual WQBELs need not be equivalent to corresponding allocations so long as the cumulative effect of all WQBELs assures attainment of WQS as quantified by the TMDL. (33 U.S.C. § 1313(d)(4)(A); 40 C.F.R. § 122.44(d)(1)(vii)(B).)”

Although failure to include the above language would not necessarily preclude subsequent flexibility in implementation, the better practice, given the public-participation requirements, would be to minimize surprises by disclosing up front that alternative attainment mechanisms may be employed.

Nonpoint Source Discharges

TMDLs must identify and grant allocations to all sources of pollution, including load allocations to nonpoint sources. The TMDLs therefore may disclose nonpoint sources as likely candidates to be offsets for point sources in addition to or apart from other point-source abatement. In appropriate circumstances, i.e., where load reductions can be calculated and enforceable, offsets may also be applied for the benefit of nonpoint sources as well as point sources.

Since the CWA does not directly regulate nonpoint sources, such discharges are subject to applicable limitations set forth under state law. California's primary mechanism to protect water quality for non-NPDES discharges (be they nonpoint source, or point source discharges to non-navigable waters) is through issuance of waste discharge requirements (WDRs) under Water Code section 13263. The extent to which offsets can be used in this context is derived from the state's authority to issue WDRs generally. Specifically:

The requirements [for waste discharge] shall implement any relevant water quality control plans that have been adopted, and shall take into consideration the beneficial uses to be protected, the water quality objectives reasonably required for that purpose, other waste discharges, the need to prevent nuisance, and the

provisions of Section 13241 [dictating matter to be considered in establishing water quality objectives]. (Water Code § 13263(a).)

Section 13241 in turn requires consideration of, among other things, “[w]ater quality conditions that could reasonably be achieved through the coordinated control of all factors which affect water quality in the area.” (Water Code § 13241(c).)

Since the basin plans protect beneficial uses and articulate water quality objectives, any WDRs issued must be protective of those uses and meet the objectives. Notably, the Regional Boards are authorized (1) to not utilize the full waste assimilation capacities of the receiving waters and (2) to utilize time schedules if they determine them appropriate in their discretion. (Water Code § 13263(b) and (c).) These authorizations may be further elucidated upon or restricted in a region’s applicable basin plan. Moreover, given Section 13241(c) of the Water Code, it would be appropriate in establishing WDRs for a particular discharger to consider the affect that other pollution control measures in the area could have on the water body. So long as such other measures are implemented, and the cumulative effect of such measures and the discharge meet water quality objectives, the level of abatement required in the WDRs could be adjusted accordingly.

Traditionally, California’s nonpoint sources have been regulated through general WDRs or general waivers of WDRs. Waivers of WDRs are subject to the restriction that the waiver not be “against the public interest.” (Water Code § 13269(a).) In its Nonpoint Source Management Plan, the state has committed to controlling nonpoint source pollution through a three-tiered approach, rather than through immediate issuance of individual WDRs. First, it will encourage self-determined pollution abatement measures. Second, it will employ regulatory incentives to achieve the desired results. Third, if the other tiers are unsuccessful, the state will issue WDRs to nonpoint source dischargers or use other direct regulatory mechanisms. (Nonpoint Source Program Strategy and Implementation Plan, 1998-2013 (PROSIP) pp. 54-60.)

The second tier is exceptionally amenable to use of conditional waivers of WDRs. Participation in an offset program that is part of a water quality attainment strategy (such as a TMDL) could be a proper condition upon which WDRs could be waived. Since the offset is part of a water quality attainment strategy, it would presumably not be against the public interest. Notably, the authority to waive WDRs is qualified by the provision that the Regional Boards must “require compliance with the conditions pursuant to which waivers are granted under this section.” (Water Code § 13269(e).) It would also be permissible to incorporate an offset as a requirement in WDRs themselves, for the same purposes as set forth above.

IV. In the absence of a TMDL, offsets must be consistent with the regulations that require all discharge permits to implement WQS.

A degree of uncertainty exists about the U.S. Environmental Protection Agency's (EPA) position on whether offsets are appropriate in the absence of a TMDL. EPA proposed an offset program that was published in the Federal Register on August 23, 1999. That program would have allowed new discharges in the absence of a TMDL, provided the new discharge and offset together demonstrated "reasonable further progress" toward attainment, and therefore did not violate the antidegradation rules. At least a 1.5 to 1 offset ratio was determined to generally constitute reasonable further progress. On July 13, 2000, however, EPA published its abandonment of the rules that would have implemented the program. Notably, the program was not abandoned for illegality, but because EPA determined its offset requirement, as proposed, was not the best mechanism to achieve progress in impaired waters in the absence of a TMDL, especially given the existing regulations set forth at 40 Code of Federal Regulations (C.F.R.) sections 122.4(d)(1)(vii), and 122.4(i).

EPA's findings were directed to the utility of a nationwide fixed offset policy, and do not necessarily imply that EPA is opposed to offsets in any given or all circumstances. In fact, there are several prominent indications to the contrary. (See e.g., Draft Framework for Watershed-Based Trading, U.S. EPA Office of Water, EPA 800-R-96-001 (May, 1996); EPA Region 9 Draft Guidance for Permitting Discharges into Impaired Waterbodies in Absence of a TMDL (5/9/00).¹) Given that no statutes or regulations directly address market-approaches to water quality regulation, any such programs must be examined within the confines of the existing regulatory structure.

New Sources: An NPDES permit cannot be issued to a new source if it would "cause or contribute" to a violation of WQS. In appropriate circumstances, however, a new discharge, coupled with an offset, might be deemed to not "cause or contribute" if the new discharge is not merely a substitute contributing source of pollution for the offset.

The NPDES regulations prohibit new discharges that would contribute to a violation of WQS:

No permit may be issued ... [¶] to] a new source or a new discharger, if the discharge from its construction or operation will cause or contribute to the violation of water quality standards. (40 C.F.R. § 122.4(i).)²

¹ Note: Since these are draft documents, they should not be relied upon as reliable authority for any position. Their inclusion here is exclusively for illustrative purposes only.

² Notably, this regulation is also qualified when a TMDL is in place, and requires the discharger to undertake a load assessment to demonstrate that additional assimilative capacity exists to allow the discharge. (40 C.F.R. § 122.4(i).)

While this language could be interpreted as prohibiting all new discharges into impaired waters without a TMDL, neither the U.S. Supreme Court nor EPA have adopted that position. (See *Arkansas v. Oklahoma* (1992) 503 U.S. 91, 107-108, but see *In The Matter of: Mayaguez Regional Sewage Treatment Plant Puerto Rico Aqueduct and Sewer Authority* (1993) 4 E.A.D. 772, fn. 21 [limiting *Arkansas* to its facts]. See also 65 Fed.Reg. 23640 col. 3.)³ In fact, it can properly be argued that a new discharge does not “cause or contribute” if coupled with an appropriate offset.

Determining whether a new discharge, coupled with an offset, will “cause or contribute to” the violation of WQS involves a degree of factual analysis, and a degree of interpretation. If a new discharger, for instance, were to propose a one-to-one mass offset from other dischargers (be they existing point or nonpoint sources) for the discharger’s increased waste load, the discharge would involve merely the substitution of one contributing source of impairment for another. A new contributing source that substitutes for an existing contributing source is still a contributing source. As such, a one-for-one offset scenario would probably be prohibited by the federal regulations.

Likewise, offsets in a venue remote to the proposed discharge would not offset the impairment-contribution from a new discharge, as the offset program would not yield benefits to the relevant water quality limited segment. Such a new discharge would merely be an additional contributing source of impairment. Again, this would appear to be prohibited by the same authorities.

On the other hand, if a discharger performs offsets greater than one-to-one, in a venue relevant to the new discharge, it may well properly be deemed to not “cause or contribute” to the impairment. In such circumstances, the net result is actually to improve water quality.

Given the regulatory prohibition against contributing to excursions above objectives, in the absence of a TMDL benchmark, the safest offsets would involve projects whose relevance to attainment of WQS should be apparent. Accordingly, if a new discharger were to instigate, for example, a legacy-abatement program, especially if such a program was probably necessary to attainment but would not readily be accomplished were it not for the efforts of the new discharger, a good argument would be apparent that the offset is not merely a substitute for an existing contributing source. If the legacy abatement efforts created significant quantifiable mass abatement above and beyond the new discharge, the cumulative effect of the discharge and offset can properly be viewed as improving water quality. Likewise, if a new source cannot meet concentration-based effluent limitations, an offset that achieved a sufficient reduction in background levels might fall within this category as it could provide room for dilution that might not otherwise be available.

³ Though not relevant to the subject of this memorandum, an obvious flaw in the no-discharge position is the fact that discharges meeting criteria end-of-pipe necessarily do not contribute to excursions above criteria.

The variable in the above analysis, however, is the lack of knowledge of the relevance of the offset to the water's impaired status. Without such knowledge, it may often be difficult to determine whether the improvement from the offset will be sufficient to defensibly reach the conclusion that the discharge is not merely a substitute cause of impairment. Any offset program in the absence of a TMDL will therefore be subject to significant scrutiny, and its defensibility in the absence of knowledge of the TMDL benchmark values, will be fact-specific, and will include an evaluation of numerous factors. These will no doubt include at least an evaluation of the substantiality of the offset achieved in exchange for the discharge (offset-ratio), as well the level of certainty that the offset program will abate a sum-certain of contributing pollutants. The inquiry may properly also include a consideration of the likelihood that the source to be offset would or could be abated through other means (the less likely the source is to be abated through other means, the more compelling the need to find alternative incentives to abate it) and whether the offset generates a permanent or temporal abatement. In any event, where a definitive improvement in water quality can be shown, such offsets ought to be encouraged.

The key legal point is that since federal law prohibits new discharges that cause or contribute to violations of water quality standards, to be defensible, any offset program must do more than substitute one contributing source for another. The program should significantly drive the watershed toward attainment or otherwise toward development of a TMDL. The key practical point is that an offset program in the absence of a TMDL should be chosen carefully to maximize the chances that a reviewing court (one that may be ideologically opposed to offsets) will find the facts compelling enough to sustain despite any skepticism.

Legacy-abatement and watershed-restoration efforts, for example, seem particularly amenable to pre-TMDL circumstances for the reasons set forth above. Such efforts may yield permanent benefits to the watershed in exchange for a temporal discharge. These offsets do not merely substitute one source for another, but create assimilative capacity through improvements to the overall environmental health of the watershed. In many cases, such efforts may ultimately need to be undertaken as part of a TMDL implementation plan in any event. Accordingly, rather than forestalling TMDL development and implementation, offsets of this nature may promote the state's performance of its TMDL obligations, and may do so in advance of formal TMDL implementation.

Existing Sources: Whether offsets can be used to allow relief from an otherwise applicable WQBEL, without a TMDL, depends upon whether the anti-backsliding rules apply, and if not, whether the discharge is protective of WQS.

1. Anti-backsliding

A key distinction between new and existing sources is the anti-backsliding rule. The anti-backsliding rule provides that, unless certain exceptions are met:

[A] permit may not be renewed, reissued, or modified . . . subsequent to the original issuance of such permit, to contain effluent limitations which are less stringent than the comparable effluent limitations in the previous permit except in compliance with section 1313(d)(4) of this title. (33 U.S.C. § 1342(o).)

Since an offset program by definition provides a discharger with an avenue to obtain flexibility in lieu of the application of an otherwise stringent effluent limitation, the extent to which the anti-backsliding rule applies could have significant consequences in terms of the permissibility of offsets. However, there are many circumstances in which the anti-backsliding rule does not apply.⁴ The most notable of these is the limitation that the rule only applies to the “comparable effluent limitations in the previous permit.” (*Id.*)

In SWRCB Order WQ 2001-06 (The Tosco Order), the State Water Resources Control Board (State Board) addressed the question of whether effluent limitations in interim permits—permits reissued prior to the adoption of a TMDL—are “comparable effluent limitations” to those in the previous permit. The Tosco Order held that the discharger’s interim performance-based effluent limitation, in a compliance schedule, was not a comparable effluent limitation to that set forth in its final limit from the previous permit. The State Board reached this result for two reasons. First, the interim limit at issue was a performance-based effluent limitation, which was issued pursuant to a compliance schedule that was authorized under the applicable Regional Water Quality Control Plan. Such interim limits, the State Board held, are not designed to attain water quality, but to preserve the status quo during the term of the compliance schedule. Furthermore, if the anti-backsliding rule were deemed to apply to such limits, it would effectively prohibit compliance schedules. (Order WQ 2001-06, pp. 51-52.) Since the previously permitted final effluent limitation was a WQBEL, and the interim limitation was performance based, the two effluent limitations were not “comparable” as they were not derived with the same considerations in mind. Instead, the “comparable limit,” the State Board held, would be the alternative final (water quality based) limit, not the interim (performance based) limit. Since the two effluent limits were not comparable, the fact that the interim limit was less stringent than the previous final effluent limit did not violate the anti-backsliding rule.⁵

⁴ 33 U.S.C. section 1342(o)(2) contains five exceptions to the anti-backsliding rule, that may render it inapplicable to a given discharge. While these are not discussed separately in this memorandum, if any of these exceptions apply, the analysis that follows would also apply.

⁵ This theory would apply whenever a compliance schedule may authorize an interim discharge in excess of limits established in a prior permit. Other authorities provide for compliance schedules in appropriate, instances, most notably, EPA’s California Toxics Rule (CTR) and the state’s policy that implements it, authorizes a compliance schedule as to CTR criteria pollutants when a discharger shows that immediate compliance with criteria is infeasible, and the discharger had committed to support and expedite development of a TMDL. (Policy for Implementation of Toxics Standards for Inland Surface Waters, Enclosed Bays, and Estuaries of California § 2.1.1 (2000).)

This finding has been challenged by a writ petition to the superior court. In that proceeding, the petitioner contends the term “comparable limit” refers to the permitted levels of pollutant discharge, not to the way the levels were derived. If the petitioners prevail, there will be far less permitting flexibility for interim permitting of existing facilities. Assuming the State Board’s finding is affirmed, however, those regions whose applicable water quality control plans authorize compliance schedules may, if they choose, adopt offset requirements in conjunction with an interim permittee’s compliance schedule. In cases where the interim limit is deemed comparable to the previous limit (be it on the basis of the Tosco reasoning or a subsequent judicial interpretation), section 402(o) may be an impediment to relaxing the effluent limitation to accommodate an offset in the absence of a TMDL.

2. Potential situations where the anti-backsliding rule may not apply

a. Bubbling of NPDES permitted sources

In the 1970s, the U.S. EPA endorsed permit “bubbling” for stationary sources subject to the federal Clean Air Act. Bubbling entailed treating multiple sources as though they were a single source, with an aggregate emissions limit. Since there was a total limit based on the bubble output, the individual sources within a given bubble could allocate the emissions amongst themselves, provided the sum of all emissions did not exceed the bubble limitation. This concept is similar to the mechanisms employed by the Grassland Bypass Project, which controls selenium in nonpoint source agricultural discharges to levels sufficiently protective that the San Luis Drain could be reopened. The San Luis Drain is treated as one outfall for purposes of the Project. As long as the Drain output attains standards, the dischargers may determine for themselves who may discharge what amount.

As noted, anti-backsliding applies only to “comparable effluent limitations in the previous permit.” Nothing in the Clean Water Act prohibits issuing a single NPDES permit that regulates several sources. Certainly the limitations set forth in such a super-permit are not “comparable” to prior limitations imposed on individual sources now subject to the super-permit. At most all that could be said is that the super-permit is comparable to the totality of all the super-permittees’ individual permits. Thus while such a super-permit could not properly expand the universe of what was individually permissible by the collective, individuals should not be deemed to backslide if the total output of the bubble does not exceed the cumulative total of the individuals. Of course, when using any bubbling mechanism, care must be taken to insure criteria are attained at all points within the bubble. A market system cannot authorize participants to discharge in a manner that would cause or contribute to excursions above criteria. (40 C.F.R. § 122.4(i); 40 C.F.R. § 122.44(d)(1)(vii)(A).)

b. Mini- or Partial TMDL

Although a TMDL may not have been created, often the major sources of impairment are well known. Frequently, abatement of these sources may be regarded as essential to any TMDL implementation plan even though such a plan is not yet being developed. Under such circumstances, it may be possible to create a mini- or partial TMDL that assigns preliminary LAs or WLAs to dischargers who undertake or participate in abatement of these sources in advance of the final TMDL. Since these LAs or WLAs would be assigned in exchange for abatement necessary to the success of the ultimate TMDL, they are plainly either “based on a [TMDL] or other waste load allocation.” (33 USC § 1313(d)(4)(A).) The CWA, which thus contemplates that WLAs can be created apart from a final TMDL, supports this interpretation. Note that, as above, even with a TMDL, local excursions above criteria must be prevented.

3. Similar to new permits, existing permits must insure compliance with WQS.

Irrespective of anti-backsliding, interim permits must protect applicable WQS. 40 C.F.R. section 122.44(d) requires that NPDES permits contain any more stringent requirements necessary to achieve water quality standards. Specifically, when WQBELs are developed, the permitting authority “shall ensure that:”

The level of water quality to be achieved by limits on point sources established under this paragraph *is derived from, and complies with all applicable water quality standards.* (40 C.F.R. § 122.44(d)(1)(vii)(A) (emphasis added).)

Moreover, permits shall incorporate “any more stringent limitation, including those necessary to meet water quality standards” or those “required to implement any applicable water quality standard established pursuant to this chapter.” (33 U.S.C. § 1311(b)(1)(C). See also 40 C.F.R. § 122.44(d)(5).)

The extent to which the above language authorizes or prohibits offsets in the absence of a TMDL is not clear. While it appears to be somewhat less proscriptive than the companion “cause or contribute” requirement applicable to new sources (see 40 C.F.R. § 122.4(i), supra), in practice they appear to have the same effect. (See e.g. 40 C.F.R. § 122.44(d)(1)(i).) Accordingly, the analysis set forth in section IV.A., supra, would be equally applicable here.

Variances

Similar to compliance schedules, which grant extensions of time to comply with criteria, the federal regulations authorize the use of variances in the State’s discretion, subject to EPA’s approval. (40 CFR § 131.13.) Where variances are authorized, Regional Boards may grant such variances in consideration of, or condition them upon, the performance of an appropriate offset which helps guarantee that protection of beneficial uses will not be compromised or that the

public interest will be served. (See Water Code § 13269.) Variances are authorized in certain circumstances, e.g., in section III.I of the California Ocean Plan (2000), as well as in the Policy for Implementation of Toxics Standards for Inland Surface Waters, Enclosed Bays, and Estuaries of California at section 5.3, for categorical and case-by-case exceptions to CTR criteria for resource and pest management, and for drinking water. Individual Regional Water Quality Control Plans may also authorize variances for conventional pollutants as well. Notably, Water Quality Order No. 2001-12-DWQ, the recent statewide general NPDES permit for the discharge of aquatic pesticides, grants such a categorical exception.

V. Conclusion

The use of offsets, pollutant trading, or other market-based mechanisms to supplement water quality regulation in impaired waters is clearly appropriate when implemented in the context of a TMDL, in which case, substantial flexibility exists to achieve WQS. For impaired waters for which no TMDL has yet been created, the anti-backsliding rules must be considered. However, when considered in the context of regulating multiple sources with a single NPDES permit (bubbling), staged TMDL efforts, or other scenarios, the anti-backsliding rules may not be a restraint on the use of market-based regulation.

For new and existing sources, the federal regulations provide that new discharges may not “cause or contribute” to violations of WQS, and that existing discharges must be “derived from and comply with” all applicable WQS. However, significant legacy abatement programs or another large-scale offsets, may well meet regulatory scrutiny depending upon fact-specific circumstances that lead the Regional Board to conclude that, even in the absence of a TMDL, the offset coupled with the discharge, creates a watershed-based improvement of a magnitude that justifies a finding that the discharge does not contribute to impairment, and is consistent with WQS. As noted above, even in the absence of a final TMDL there may nonetheless be significant flexibility in certain circumstances, which must be evaluated within the context of the facts presented.

In any event, given the scope of California’s obligations under CWA section 303(d), specifically the roughly 1400 TMDLs that must be adopted, as a practical matter, care should be taken that creative mechanisms, in advance of a TMDL, should be promotive of TMDL development or attainment of criteria generally.

Should you have any questions about this memorandum, please contact me at 341-5150, or Staff Counsel Michael Levy at 341-5193 or mlevy@exec.swrcb.ca.gov.

cc: See next page

cc: Celeste Cantú, Exec.
Tom Howard, Exec.
Stan Martinson, DWQ
Thomas Mumley, San Francisco RWQCB
Ted Cobb, OCC
Phil Wyels, OCC
WQ Attorneys

Attachment C.

Antidegradation Analysis for Proposed
Discharges to Big Bear Lake and Shay Pond



REPLENISH
— Big Bear —

Antidegradation Analysis for Proposed Discharges to Stanfield Marsh/Big Bear Lake and Shay Pond

Prepared by:
Water Systems Consulting, Inc &
Larry Walker Associates

February 2022



Acknowledgment of Credit

This report is financed under the Water Quality, Supply and Infrastructure Improvement Act of 2014, administered by the State of California, Department of Water Resources.



This page was intentionally left blank

TABLE OF CONTENTS

Table of Contents	i
List of Tables.....	iii
List of Figures.....	iv
List of Acronyms.....	v
List of Appendices	vii
Executive Summary.....	ES-1
Project Description.....	ES-1
Water Quality Impacts of Proposed Discharges.....	ES-3
Consistency with Antidegradation Policies	ES-4
1 Introduction.....	1
1.1 Program Overview	1
1.2 Project Description	4
1.3 Purpose of Report.....	7
1.4 Analysis Approach	8
2 Regulatory Requirements	9
2.1 Applicable Laws and Policies	9
2.2 Federal Policies and Guidance	9
2.3 State Policies and Guidance	11
2.3.1 Resolution 68-16	11
2.3.2 1987 Policy Memorandum	12
2.3.3 Administrative Procedures Update (APU) 90-004.....	12
3 Applicable Water Quality Standards	14
3.1 Beneficial Uses.....	14
3.2 Water Quality Objectives/Water Quality Criteria.....	15
3.3 303 (d) Listings.....	18
3.4 Lake Nutrient TMDL.....	19
3.5 Statewide Mercury Provisions.....	20
3.6 Title 22 Recycled Water Criteria	20

4	Environmental Setting.....	21
4.1	Stanfield Marsh.....	21
4.2	Big Bear Lake	21
4.3	Santa Ana Watershed.....	23
5	Assessment of Water Quality Impacts to Big Bear Lake	25
5.1	Lake Discharge Project Description.....	25
5.2	Selection of Water Quality Constituents.....	27
5.2.1	Selection Criteria.....	27
5.2.2	Data Sources	28
5.2.3	Selection of Constituents	32
5.3	Water Quality Impacts Assessment.....	35
5.3.1	Lake Analysis Model Analysis Results	35
5.3.2	Boron Mass Balance.....	41
5.4	Summary of Water Quality Impacts.....	43
6	Assessment of Water Quality Impacts to Shay Pond.....	44
6.1	Shay Pond Environmental Setting and Project Description.....	44
6.2	Applicable Water Quality Standards	47
6.3	Assessment of Water Quality Impacts.....	48
7	Evaluation of Consistency with Antidegradation Policy	52
7.1	Benefits of Proposed Project.....	52
7.2	Socioeconomic Considerations	54
7.3	Consistency with Antidegradation Policies	55
8	References	57

LIST OF TABLES

Table 1. Beneficial Uses of Lake and Stanfield Marsh	15
Table 2. Applicable WQOs and/or Criteria for the Lake Discharge	16
Table 3. 2018 CWA Section 303(d) Listed Constituents	18
Table 4. Nutrient TMDL Numeric Targets for All Hydrologic Conditions	19
Table 5. Projected Effluent Quality of Proposed Discharge and Existing Secondary Effluent Quality	26
Table 6. Summary Statistics for Constituents Evaluated in Secondary Effluent and Big Bear Lake	30
Table 7. Comparison of Most Stringent Water Quality Objective or Criterion to Existing Ambient Lake Water Quality and Projected Effluent Quality of Proposed Discharge	33
Table 8. Initial and Updated Lake Discharge Flow Rate Projections.....	36
Table 9. Predicted Long-term Average Lake Concentrations for TDS, TIN, TN, TP, and Chlorophyll-a Under Different Operational Scenarios	37
Table 10. Predicted Frequency of Exceeding TMDL Target Under Baseline Conditions and Different Lake Discharge Rates and TP Offset Scenarios (Annual Average or Growing Season Average Basis)	39
Table 11. Predicted Lake Level, Area, and Volume under Three Hydrologic Scenarios.....	40
Table 12. Beneficial Uses of Shay Pond Receiving Waters.....	47
Table 13. Comparison of Most Stringent Water Quality Objective or Criterion to Current BBCCSD Potable Water Supply Quality and Projected Effluent Quality of Proposed Discharge	50

LIST OF FIGURES

Figure 1. Replenish Big Bear Program Lake and Shay Pond Discharge Locations . 3
Figure 2. Replenish Big Bear Program Subsequent Uses of Lake Water 4
Figure 3. BBARWA Existing WWTP Process Flow Diagram 5
Figure 4. BBARWA Proposed WWTP Treatment Upgrades Flow Diagram 6
Figure 5. Overview of Lake Discharge Location in Reference to Stanfield Marsh/Lake 14
Figure 6. Big Bear Lake Levels: 2000 – 2021 23
Figure 7. Santa Ana Watershed Map 24
Figure 8. Projected 2040 Monthly BBARWA Discharges to the Lake under Three Inflow Scenarios..... 36
Figure 9. CDFs for Predicted Annual TP and TN Concentrations and Growing Season Average Chlorophyll-a Concentrations for Baseline Condition and at 2,210 AFY Lake Discharge with and without TP Offset 39
Figure 10. Projected Boron Concentrations with Proposed Lake Discharge 43
Figure 11. Population of Stickleback Fish in the Vicinity of Shay Pond..... 46
Figure 12. Shay Pond Aerial View..... 47

LIST OF ACRONYMS

4,4' DDT	4,4' Dichlorodiphenyltrichloroethane
AF	Acre Foot
AFY	Acre Feet Per Year
AGR	Agricultural Supply Beneficial Benefit
APU	Administrative Procedures Update
BBARWA	Big Bear Area Regional Wastewater Agency
BCCSD	Big Bear City Community Service District
BBLDWP	Big Bear Lake Department Of Water And Power
BBMWD	Big Bear Municipal Water District
BO	Biological Opinion
BOD	Biological Oxygen Demand
BVBGSA	Bear Valley Basin Groundwater Sustainability Agency
CCC	Criterion Continuous Concentration
CDFW	California Department Of Fish And Wildlife
CEQA	California Environmental Quality Act
COLD	Cold Freshwater Habitat Beneficial Benefit
CSA53	County of San Bernardino Service Area
CTR	California Toxics Rule
CWA	Clean Water Act
DAC	Disadvantaged Community
DDW	California State Water Resources Control Board Division Of Drinking Water
DO	Dissolved Oxygen
EIR	Environmental Impact Report
GPM	Gallons Per Minute
GSP	Groundwater Sustainability Plan
GWR	Groundwater Recharge Beneficial Benefit
LWA	Larry Walker Associates
MCL	Maximum Contaminant Level
MG	Million Gallons
MGD	Million Gallon Per Day
MUN	Municipal And Domestic Supply Beneficial Benefit
NPDES	National Pollutant Discharge Elimination System
NTR	National Toxics Rule
MBAS	Methylene Blue-Activated Substances
MDL	Method Of Detection Limit

mg/L	Milligrams Per Liter
MSL	Mean Sea Level
Mutual	Bear Valley Mutual Water Company
N/A	Not Applicable
ND	Non-Detect
NS	Not Sampled
O&M	Operations And Maintenance
PCB	Polychlorinated Biphenyls
REC1	Water Contact Recreation Beneficial Benefit
REC2	Non-Contact Water Recreation Beneficial Benefit
RARE	Rare, Threatened, Or Endangered Species Beneficial Benefit
RL	Reporting Limit
RO	Reverse Osmosis
ROWD	Report Of Waste Discharge
SAR	Santa Ana River
SBNF	San Bernardino National Forest
SBVMWD	San Bernardino Valley Municipal Water District
SPWN	Spawning, Reproduction, and/or Early Development Beneficial Benefit
SWP	State Water Project
SWRCB	State Water Resources Control Board
TDS	Total Dissolved Solids
TIN	Total Inorganic Nitrogen
TKN	Total Kjeldahl Nitrogen
TM	Technical Memorandum
TMDL	Total Maximum Daily Load
TN	Total Nitrogen
TOT	Transient Occupancy Tax
TP	Total Phosphorus
TSS	Total Suspended Solids
U.S. EPA	United States Environmental Protection Agency
USFWS	United States Fish And Wildlife Service
UV	Ultraviolet
VOCs	Volatile Organic Compounds
WARM	Warm Freshwater Habitat Beneficial Benefit
WDR	Waste Discharge Requirements
WILD	Wildlife Habitat Beneficial Benefit
WLA	Wasteload Allocation
WOTUS	Waters Of The U.S

WQO	Water Quality Objective
WSC	Water Systems Consulting
WWTP	Wastewater Treatment Plant

LIST OF APPENDICES

A	WDR R7 R7-2021-0023
B	Big Bear Lake Analysis: Replenish Big Bear
C	Replenish Big Bear: Modeling Of Higher Flows And With Zero TP Load
D	Secondary Effluent, Big Bear Lake, and Shay Pond Water Quality Data for Antidegradation Analysis
E	Big Bear Lake Ammonia and Hardness Calculations
F	Boron Mass Balance Analysis with Boron Lake Discharge

EXECUTIVE SUMMARY

Project Description

The Big Bear Area Regional Wastewater Agency (BBARWA) operates an existing regional wastewater treatment plant (WWTP) and related facilities in the Big Bear Valley (Valley). BBARWA has partnered with Big Bear City Community Service District (BBCCSD), Big Bear Lake Department of Water and Power (BBLDWP), Big Bear Municipal Water District (BBMWD), and Bear Valley Basin Groundwater Sustainability Agency (BVBGSA), collectively known as the Agency Team, to develop the Replenish Big Bear Program. The Replenish Big Bear Program is intended to help protect the Valley and the Santa Ana Watershed from the impacts of drought and variable precipitation by recovering a water resource currently discharged outside of the watershed. The program is comprised of several elements; the first project includes treatment upgrades at the BBARWA WWTP to produce disinfected, advanced treated effluent by providing tertiary filtration, reverse osmosis (RO) treatment, and ultraviolet (UV) disinfection for 100% of the water proposed to be discharged to Stanfield Marsh Wildlife and Waterfowl Preserve (Stanfield Marsh), a tributary of Big Bear Lake (Lake) and a separate discharge to Shay Pond, a tributary of Shay Creek. These discharges are referred to as the “Lake discharge” and the “Shay Pond discharge” and the approximate discharge locations are shown in **Figure ES-1**.

The new BBARWA WWTP facilities will be designed for a treatment capacity of 2.2 million gallons per day (MGD). By 2040, accounting for expected growth, it is estimated that the WWTP could produce 2,210 acre-feet per year (AFY) of advanced treated effluent, assuming a 99% total recovery rate could be achieved (90% RO recovery and 90% recovery of brine through brine minimization). Up to 80 AFY of the disinfected, advanced treated effluent will be sent to Shay Pond discharge, and any remaining disinfected, advanced treated effluent will be sent to the Lake discharge. All remaining flows in excess of the new treatment train’s 2.2 MGD capacity will continue to be treated to undisinfected secondary standards and conveyed to BBARWA’s existing Lucerne Valley site, which is regulated by the Colorado River Basin Regional Water Quality Control Board.

As described in the Technical Memorandum (Attachment B of the ROWD package) titled *Approach to Address Big Bear Lake Nutrient Total Maximum Daily Load in the NPDES Permit for Big Bear Area Regional Wastewater Agency (WSC & LWA, 2022)*, the Agency Team proposes to implement a total phosphorus (TP) Offset Program for the Lake discharge to attain net zero TP loads to the Lake to be consistent with the assumptions of the Big Bear Lake Nutrient Total Maximum

Antidegradation Analysis for Proposed Discharges to Stanfield Marsh/Big Bear Lake and Shay Pond

Daily Load (Nutrient TMDL) for Dry Hydrologic Conditions. While a portion of the disinfected, advanced treated effluent is planned for discharge to Shay Pond, the maximum anticipated Lake discharge of 2,210 AFY, coupled with the TP Offset Program in the Lake, is the basis of the antidegradation analysis for the Lake discharge. Modeling analysis has also been conducted to evaluate a range of additional scenarios; these results are presented herein to provide additional information.

The proposed Lake discharge will be physically discharged at the east end of Stanfield Marsh, then flow through the Marsh into the Lake through a set of culverts under Stanfield Cutoff. Due to prolonged drought conditions, Stanfield Marsh has been mostly dry since 2015. Therefore, current ambient water quality data is not available. Additionally, the water quality objectives (WQOs) specified for the Lake in the Water Quality Control Plan for the Santa Ana River Basin (Basin Plan) are more stringent than those for Stanfield Marsh. Therefore, this antidegradation analysis focuses on the impacts to water quality in the Lake.

This antidegradation analysis provides the Santa Ana Regional Water Quality Control Board (Regional Water Board) with the information needed to determine whether the proposed Lake discharge and Shay Pond discharge are consistent with the State of California (State) and federal antidegradation policies.

Note that the Replenish Big Bear Program also includes subsequent uses of Lake water for purposes such as 1) landscape irrigation, construction uses, and snowmaking at the golf course and ski resort and 2) direct groundwater recharge in Sand Canyon. It is anticipated that these uses will be regulated separately and are not discussed in this antidegradation report. Coordination with the California State Water Resources Control Board Division of Drinking Water (DDW) is underway to regulate these recycled water uses.



Figure ES - 1. Replenish Big Bear Program Lake and Shay Pond Discharge Locations

Water Quality Impacts of Proposed Discharges

The Replenish Big Bear Program Lake discharge is anticipated to improve Lake water quality for total dissolved solids (TDS), total phosphorus (TP), total nitrogen (TN), and chlorophyll-a as compared to modeled baseline (no project) conditions, and result in similar water quality for total inorganic nitrogen (TIN) as compared to the modeled baseline. In addition, the proposed discharge is anticipated to feature concentrations similar to or lower than ambient water quality and the most stringent WQO or criterion for all constituents evaluated except for boron. For boron, concentrations in the Lake are anticipated to increase as compared to baseline conditions, but remain well below the most stringent WQO of 0.75 mg/L.

The Shay Pond discharge is anticipated to be of better quality than the current potable water supply and ambient water quality for most constituents of interest. However, additional data may be needed to confirm these findings. Like the Lake discharge, boron may be the only constituent in the disinfected, advanced treated effluent discharged to Shay Pond that could be above existing ambient water quality for the constituent. However, it is well below the WQO of 0.75 mg/L that exists for the protection of water used to irrigate boron-sensitive agricultural crops, which is not a use of the water in Shay Pond. Additional coordination with the California Department of Fish and Wildlife (CDFW) will be conducted to ensure the Unarmored Threespine Stickleback (Stickleback) fish, a federally and State listed endangered species, and located in Shay Pond are protected.

Consistency with Antidegradation Policies

The proposed project, the discharge of disinfected, advanced treated BBARWA effluent to (1) Stanfield Marsh/ Lake at a discharge rate up to 2,210 AFY and (2) Shay Pond at a discharge rate up to 80 AFY, is determined to comprise best practicable treatment and control and is consistent with federal and State antidegradation policies for the following reasons:

- The proposed discharge to both Stanfield Marsh/ Lake and Shay Pond will not adversely affect existing or probable beneficial uses of either receiving water or downstream receiving waters, nor will the discharges cause water quality to not meet applicable water quality objectives.
- Overall, the proposed discharge is estimated to improve water quality in the Lake for TDS, TN, TP, and chlorophyll-a, maintain similar water quality for TIN, and have a very minor impact on boron. Future boron concentrations in the Lake are estimated to increase very slightly due to the proposed BBARWA discharge but are estimated to remain well below the 0.75 mg/L Basin Plan objective for boron (see **Table 7** and **Section 5.3.2**). The Lake Analysis shows that projected ambient Lake concentrations of TIN and chlorophyll-a with the proposed discharge will exist below their relevant WQO (TIN) or TMDL target (chlorophyll-a). The Lake Analysis also shows that ambient Lake concentration of TDS and TP with the proposed discharge are estimated to exceed the 175 mg/L TDS WQO and the 35 µg/L TP TMDL target, respectively. However, the modeled baseline (no project) condition is projected to result in Lake concentrations for TDS, TP, TIN, and chlorophyll-a that exceed those concentrations more often than all modeled BBARWA discharge scenarios. Modeled results for the proposed BBARWA discharge, when combined with a TP Offset Program (see Attachment B of the ROWD package), show the greatest improvements to future, ambient Lake concentrations as compared to the modeled baseline (no project) condition.

Antidegradation Analysis for Proposed Discharges to Stanfield Marsh/Big Bear Lake and Shay Pond

- Overall, the proposed BBARWA discharge is estimated to have a very minor impact on Shay Pond water quality and Shay Creek water quality downstream of the pond. The proposed project is estimated to potentially cause a very minor increase in boron concentrations in the pond and downstream in Shay Creek, but concentrations are estimated to remain well below the 0.75 mg/L Basin Plan objective for boron. The disinfected, advanced treated effluent proposed for discharge to the pond is anticipated to lower the concentrations of those constituents listed in **Table 13** as compared to existing ambient concentrations that are largely influenced by the groundwater currently discharged by BBCSD to the pond to maintain water levels for the endangered Stickleback.
- Based on the above, the request to permit a new discharge to both Stanfield Marsh/ Lake and Shay Pond is consistent with federal and State antidegradation policies in that the minor lowering of water quality boron in the Lake (see **Table 7**) and Shay Pond (see **Table 13**) is necessary to accommodate important economic or social development¹, will not unreasonably affect beneficial uses, will not cause further exceedances of applicable WQOs, and is consistent with the maximum benefit to the people of the State.
- Based on the above, the request to permit new discharges to Stanfield Marsh/ Lake and Shay Pond are consistent with the Porter-Cologne Act in that the resulting water quality will constitute the highest water quality that is reasonable, considering all demands placed on the waters, economic and social considerations, and other public interest factors.

The proposed discharge of disinfected, advanced treated BBARWA effluent to Stanfield Marsh/ Lake and Shay Pond also fully supports California's *Recycled Water Policy* (SWRCB, 2013) in that it would result in an increased use of recycled water from municipal wastewater sources, would incrementally reduce reliance on the vagaries of annual precipitation, and would assist in the sustainable management of surface and groundwater resources.

¹ Maintain and improve recreation and tourism in the Big Bear Lake region which in turn stimulates the local and regional economies.

1 INTRODUCTION

This section provides an overview of the Replenish Big Bear Program, description of the proposed discharges to Stanfield Marsh, a tributary of the Lake, and a separate discharge to Shay Pond, a tributary of Shay Creek. This section also discusses the purpose and approach used in this antidegradation analysis report.

1.1 Program Overview

BBARWA is a joint powers authority formed in 1974 to provide centralized wastewater conveyance, treatment, and disposal for the City of Big Bear Lake, representing approximately 47% of the total connections, BBCCSD, representing approximately 48% of the total connections, and County of San Bernardino Service Area 53B (CSA53), representing approximately 5% of the total connections. Each of these member agencies maintains and operates its own wastewater collection system that conveys wastewater to BBARWA's interceptor system for transport to the BBARWA WWTP. The BBARWA service area includes the entire Valley and covers about 79,000 acres. BBARWA owns and operates a regional WWTP to treat the Valley's wastewater and currently discharges undisinfected secondary effluent to Lucerne Valley, which is located outside the Santa Ana Watershed.

The Replenish Big Bear Program is a collaborative regional water resources program being implemented by Agency Team to help protect the Valley and the Santa Ana Watershed from the impacts of drought and variable precipitation through the recovery of this local water resource currently discharged outside of the watershed.

The Replenish Big Bear Program is comprised of three independent projects:

- 1) Discharge of disinfected, advanced treated effluent to Stanfield Marsh, which is tributary to the Lake, and a separate discharge to Shay Pond;
- 2) Use of Lake water for purposes such as landscape irrigation of the local golf course, construction uses and snowmaking; and
- 3) Use of Lake water for groundwater recharge in Sand Canyon.

The first project is the subject of this antidegradation analysis and is foundational to the Replenish Big Bear Program and necessary to enable implementation of the subsequent uses of Lake water. As part of the first project, the BBARWA WWTP will be upgraded to produce disinfected, advanced treated effluent through tertiary filtration using ultrafiltration, and RO treatment with UV disinfection for the proposed discharges to the Lake and Shay Pond.

Antidegradation Analysis for Proposed Discharges to Stanfield Marsh/Big Bear Lake and Shay Pond

Although the proposed Lake discharge will be physically discharged at the east end of Stanfield Marsh, then flow through the Marsh into the Lake through a set of culverts under Stanfield Cutoff, this antidegradation analysis was completed for the Lake since Stanfield Marsh has been mostly dry since 2015. Therefore, current ambient water quality data is not available for this antidegradation analysis. Additionally, the WQOs specified for the Lake in the Basin Plan are more stringent than those for Stanfield Marsh.

Figure 1 shows the WWTP and proposed discharge locations, which are components of the first project. The proposed project's two discharge points will allow BBARWA to minimize the discharge of disinfected, advanced treated effluent outside of the watershed. The Lake discharge will increase Lake levels to better support beneficial uses including recreation and habitat, particularly during times of drought. The Shay Pond discharge will replace potable water currently discharged to the waterbody to maintain the water flow through the pond. Up to 80 AFY of disinfected, advanced treated effluent will be sent to Shay Pond, and any remaining disinfected, advanced treated effluent will be sent to the Lake.



Figure 1. Replenish Big Bear Program Lake and Shay Pond Discharge Locations

The other two projects will utilize Lake water for purposes such as 1) landscape irrigation, construction uses, and snowmaking at the ski resort, and 2) direct groundwater recharge in Sand Canyon. **Figure 2** shows the general location of these two projects. The golf course irrigation, construction uses, and snowmaking project can be implemented using existing infrastructure used for snowmaking that draws water from the Lake. The Sand Canyon recharge project will require construction of a pump station, pipeline, recharge ponds and monitoring wells and may be implemented in parallel with the Lake discharge.

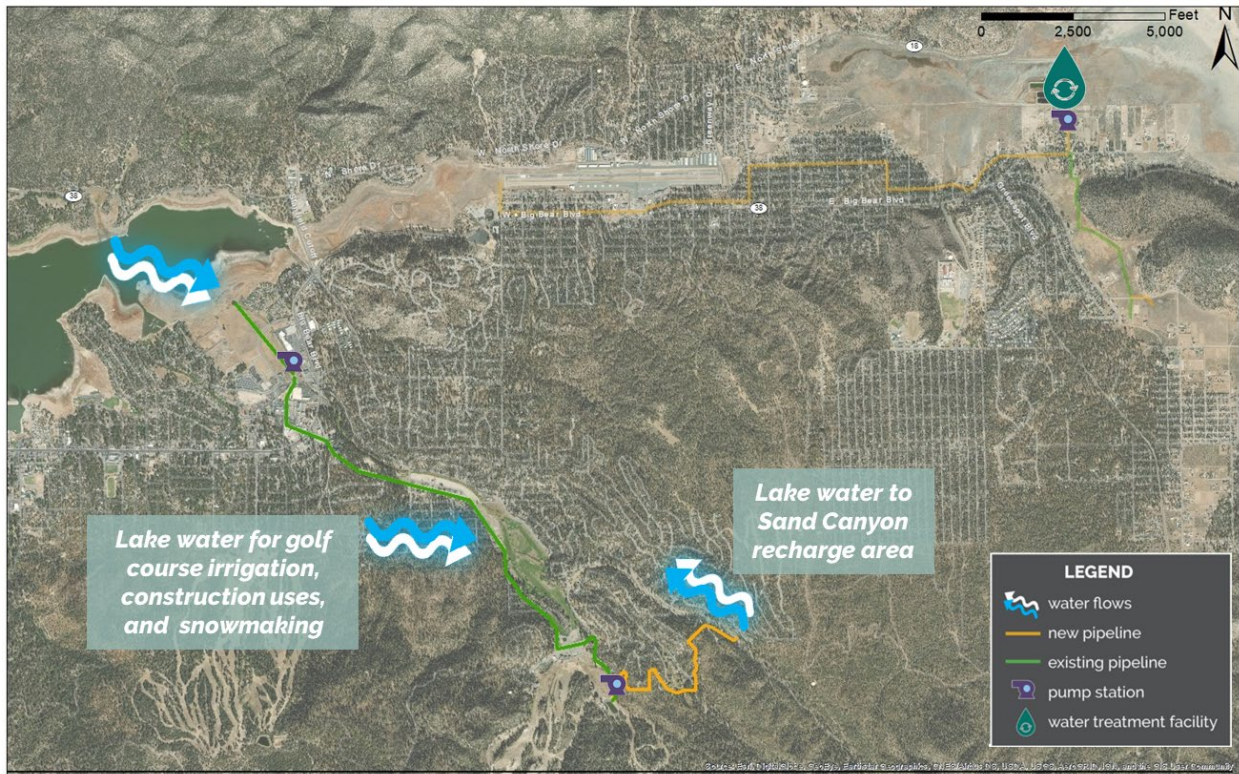

Figure 2. Replenish Big Bear Program Subsequent Uses of Lake Water

1.2 Project Description

The discharge of disinfected, advanced treated effluent to Stanfield Marsh, which is tributary to the Lake, and a separate discharge to Shay Pond is the subject of this antidegradation analysis. The proposed discharges require the construction of WWTP upgrades, an effluent booster pump station at the WWTP site and approximately seven (7) miles of pipeline to convey water to the discharge locations.

Figure 3 shows a process flow diagram of the existing BBARWA WWTP treatment process.

Antidegradation Analysis for Proposed Discharges to Stanfield Marsh/Big Bear Lake and Shay Pond

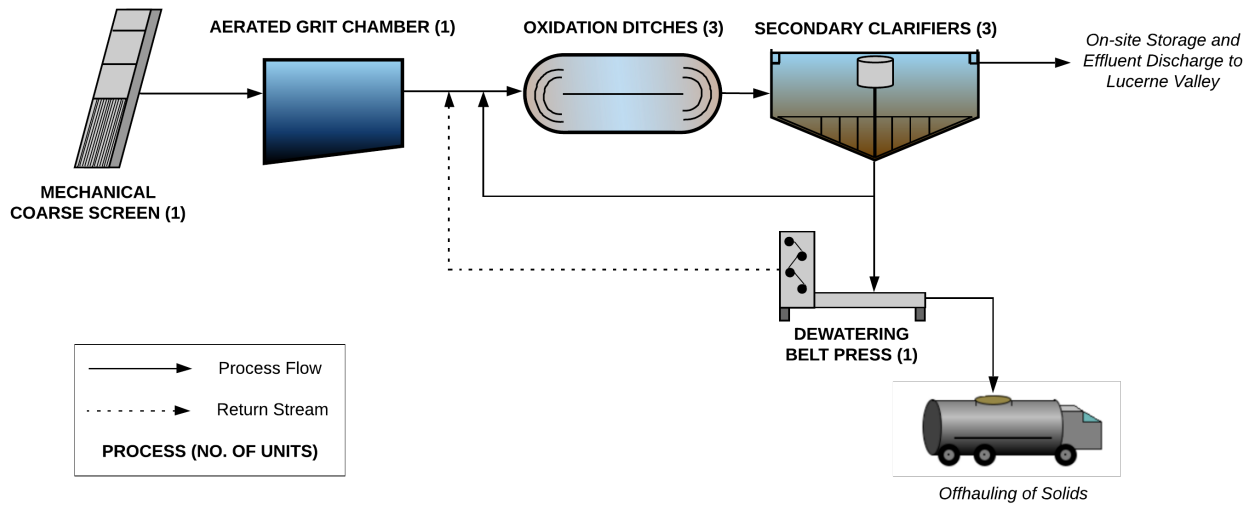

Figure 3. BBARWA Existing WWTP Process Flow Diagram

The existing BBARWA WWTP secondary treatment facility has a capacity of 4.89 MGD and a hydraulic capacity of 9.1 MGD. The WWTP treats commercial and domestic wastewater from the City of Big Bear Lake, BBCSD, and CSA53 collection systems. The existing treatment process includes the following:

- Preliminary treatment consisting of a mechanical coarse screen and an aerated grit chamber;
- Secondary treatment consisting of extended aeration oxidation ditches and secondary clarifiers; and
- Solids handling through a dewatering belt filter press.

Treated effluent is temporarily stored on-site prior to discharge to Lucerne Valley and dewatered solids are hauled off-site. The undisinfected secondary effluent discharged to Lucerne Valley is currently used to irrigate crops used for livestock feed. This discharge is regulated under Order R7-2021-0023 Waste Discharge Requirements (WDR) permit, issued by the Colorado River Basin Regional Water Quality Control Board (**Appendix A**).

The proposed upgrades, as shown in **Figure 4**, to the BBARWA WWTP to produce disinfected, advanced treated effluent include:

- Biological nutrient removal improvements to the existing oxidation ditches for improved nitrification and denitrification;
- Tertiary filtration and nitrogen and phosphorus removal via denitrification filters;

Antidegradation Analysis for Proposed Discharges to Stanfield Marsh/Big Bear Lake and Shay Pond

- Low- and high-pressure filtration with ultrafiltration (UF) membranes and 90% recovery RO membranes;
- Brine pellet reactor for brine minimization to produce a total system recovery of 99%; and
- UV disinfection.

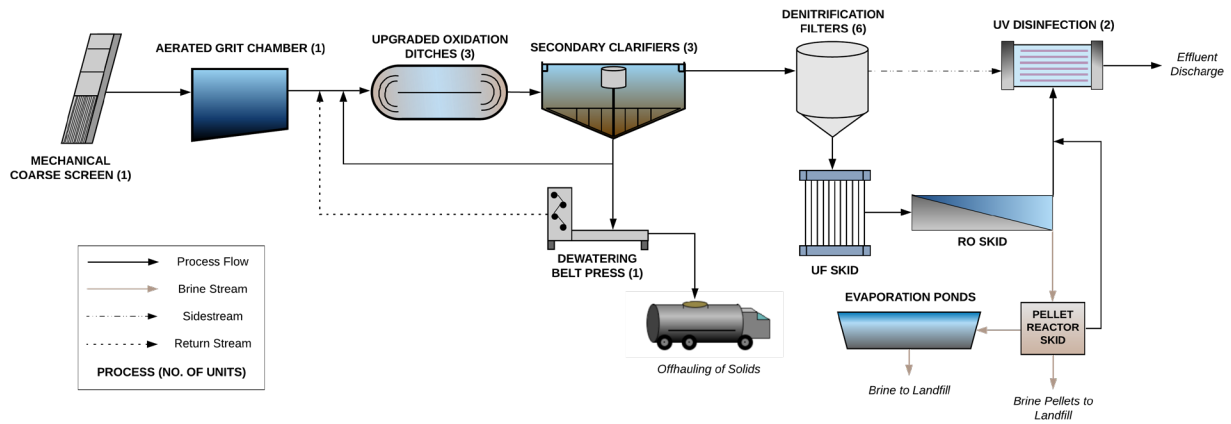

Figure 4. BBARWA Proposed WWTP Treatment Upgrades Flow Diagram

The proposed upgrades (i.e., new advanced treatment train) would be designed for a treatment capacity of 2.2 MGD. By 2040, accounting for expected growth, it is estimated that the WWTP could produce 2,210 AFY of advanced treated effluent, assuming a 99% total recovery rate could be achieved (90% RO recovery and 90% recovery of brine through brine minimization). The WWTP currently produces about 2.0 MGD of undisinfected secondary effluent on an average annual basis.

The RO brine management option included in the preliminary design for Replenish Big Bear is a brine minimization pellet reactor to reduce the volume of brine produced by the RO process. The reduced brine stream from the pellet reactor will be conveyed to evaporation ponds located on BBARWA WWTP property. It is assumed that an RO recovery of 90% at 2.2 MGD influent flow would result in 0.22 MGD of RO brine to be minimized through the pellet reactor and approximately 0.022 MGD of liquid brine to be conveyed to the evaporation pond based on a pellet reactor recovery of 90%. A total evaporation pond area of 23 acres is needed for the brine stream. The RO brine management strategy will be evaluated further as the Project enters the design phase, along with refinements to total system recoveries based on site-specific piloting results.

BBARWA also plans to maintain the existing Lucerne Valley discharge location. All WWTP process water in excess of the new treatment train's 2.2 MGD capacity will continue to be treated to undisinfected secondary levels and conveyed to the existing Lucerne Valley site, consistent with the current, permitted discharge requirements of the existing BBARWA WWTP.

1.3 Purpose of Report

As required by the Clean Water Act (CWA), the discharge of any pollutant or combination of pollutants to surface waters that are deemed waters of the United States (U.S.), as is the Lake discharge and potentially Shay Pond discharge, must be regulated by a National Pollutant Discharge Elimination System (NPDES) permit. Because the two proposed discharge locations are new discharges to surface waters of the U.S., a NPDES permit governing the proposed discharges must be requested from the Regional Water Board.

Under the State and federal antidegradation policies, the Regional Water Board is required to make a finding regarding the satisfaction of the policies as they pertain to surface water discharges for which the Regional Water Board issues a NPDES permit. The State antidegradation policy, which incorporates the federal antidegradation policy, seeks to maintain the existing high quality of water to the maximum extent possible, and only allows a lowering of water quality if:

- Changes in water quality are consistent with maximum benefit to the people of the state, will not unreasonably affect present and potential beneficial uses, and will not result in water quality lower than applicable standards, and
- Waste discharge requirements for a proposed discharge will result in the best practicable treatment or control of the discharge necessary to assure:
 - No pollution or nuisance; and
 - Highest water quality consistent with maximum benefit to the people of the State.

The purpose of this report is to provide the Regional Water Board with the information needed to determine whether the proposed discharges are consistent with State and federal antidegradation policies. This antidegradation analysis includes assessments of water quality impacts on the receiving waters and downstream receiving waters estimated to result from the proposed project; an evaluation of how these estimated changes in water quality compare to applicable WQO and relevant water quality criteria; how estimated changes in water quality may affect existing or probable beneficial uses; and a finding of consistency with antidegradation policies.

1.4 Analysis Approach

The following antidegradation analysis is tailored to be consistent with federal and State antidegradation policies and the guidance provided in the Administrative Procedures Update (APU) 90-004. Pursuant to the APU guidelines, this analysis follows the provisions for a “simple analysis” and evaluates whether changes in water quality resulting from the proposed new discharges to the Lake and Shay Pond are “*consistent with maximum benefit to the people of the State, will not unreasonably affect uses and will not cause water quality to be less than water quality objectives and that the discharge provides protection of existing in-stream beneficial uses and water quality necessary to protect those uses.*”

In general, the data available for existing secondary effluent quality, projected disinfected advanced treated effluent quality, and ambient water quality were assessed to determine if the proposed future discharge would result in concentrations that exceed existing ambient water quality and/or relevant WQOs or criteria. For constituents anticipated to lead to a lowering of existing ambient water quality or an exceedance of relevant WQOs or criteria, further analysis was conducted.

Additionally, TDS, TIN, TN, TP, and chlorophyll-a were evaluated using a two dimensional (2D) hydrodynamic-water quality model (CE-QUAL-W2) developed for Big Bear Lake by Dr. Michael A. Anderson (Dr. Anderson), a limnologist who has in-depth knowledge of the Lake. The model evaluation was conducted to help select the preferred treatment alternative and assess the impacts of the proposed Lake discharge on constituents of interest. The water quality impacts with and without the proposed project were assessed for three different treatment alternatives as documented in *Big Bear Lake Analysis: Replenish Big Bear* (2021 Lake Model Analysis; **Appendix B**). Additional model updates were recently completed to incorporate additional discharge volume scenarios and seasonal variability and documented in *Replenish Big Bear: Modeling of Higher Flows and with Zero TP Load* (2022 Lake Model Update; **Appendix C**). The model results from both analyses are discussed in this report.

For constituents not able to be evaluated by the CE-QUAL-W2 model, their potential impacts with regard to a lowering of existing ambient water quality and/or the exceedance of relevant WQOs or criteria were assessed using a simple mass balance equation.

2 REGULATORY REQUIREMENTS

This section summarizes the federal and State antidegradation policies considered in this antidegradation analysis.

2.1 Applicable Laws and Policies

The federal Clean Water Act (CWA) requires states to adopt, with United States Environmental Protection Agency (U.S. EPA) approval, water quality standards applicable to all intrastate waters (33 U.S.C. § 1313). U.S. EPA regulations also require state water quality standard submittals to include an antidegradation policy to protect beneficial uses and prevent further degradation of high-quality waters (33 U.S.C. § 1313(d)(4)(B); 40 C.F.R. § 131.12). The State's antidegradation policy is embodied in State Water Resources Control Board (SWRCB) Resolution 68-16.

BBARWA's requested discharge of disinfected, advanced treated effluent to the Lake and to Shay Pond requires the application of WQOs contained in the Basin Plan, as well as criteria promulgated by the U.S. EPA for California waters. Both the federal and State antidegradation policies apply to the proposed surface water discharges of treated effluent to the Lake and to Shay Pond.

2.2 Federal Policies and Guidance

The federal antidegradation policy is designed to protect existing uses and the level of water quality necessary to protect existing uses and provide protection for higher quality and outstanding national water resources. The federal policy directs states to adopt a statewide policy that includes the following primary provisions (40 C.F.R. § 131.12).

- 1) *Existing in-stream water uses and the level of water quality necessary to protect the existing uses shall be maintained and protected.*

Antidegradation Analysis for Proposed Discharges to Stanfield Marsh/Big Bear Lake and Shay Pond

- 2) *Where the quality of waters exceeds levels necessary to support propagation of fish, shellfish, and wildlife and recreation in and on the water, that quality shall be maintained and protected unless the State finds, after the full satisfaction of the intergovernmental coordination and public participation provisions of the State's continuing planning process, that allowing lower water quality is necessary to accommodate important economic or social development in the area in which the waters are located. In allowing such degradation or lower water quality, the State shall assure water quality adequate to protect existing uses fully. Further, the State shall assure that there shall be achieved the highest statutory and regulatory requirements for all new and existing point sources and all cost effective and reasonable best management practices for nonpoint source control*
- 3) *Where high quality waters constitute an outstanding National resource, such as water of National and State parks and wildlife refuges and waters of exceptional recreational or ecological significance, that water quality shall be maintained and protected.*
- 4) *In those cases where potential water quality impairment associated with a thermal discharge is involved, the antidegradation policy and implementing method shall be consistent with Section 316 of the Act.*

Based on guidance developed by the U.S. EPA, Region 9 (Guidance on Implementing the Antidegradation Provisions of 40 C.F.R. § 131.12 (U.S. EPA, 1987)) and guidance issued by SWRCB with regard to application of the Federal Antidegradation Policy (Memorandum from William R. Attwater to Regional Board Executive Officers Federal Antidegradation Policy (Attwater, Oct. 1987)), application of the federal antidegradation policy is triggered by a lowering, or potential lowering, of surface water quality. A proposed increase in the volume of an existing discharge or a new discharge to surface water is typically considered a trigger to the application of the federal antidegradation policy. Because the Project is proposing two new discharges to surface waters, the federal antidegradation policy applies.

Both the Lake and Shay Pond are not designated as outstanding natural resource waters and therefore, the receiving waters are not subject to that portion of the federal policy. The application to other portions of the policy is determined on a constituent-by-constituent basis. For a water body where water quality is not significantly better than needed to meet designated uses, either because it does not meet or it just meets applicable water quality objectives or criteria to protect beneficial uses, a new discharge cannot cause further impairment.

For waters with water quality that is better than necessary to support beneficial uses, the new discharge may not lower water quality unless such lowering is necessary to accommodate important economic or social development. In August 2005, the U.S. EPA issued a memorandum discussing antidegradation reviews and significance thresholds (Memorandum from Ephraim S. King, Director, Office of Science and Technology, U.S. EPA, Office of Water to Water Management Division Directors, Regions 1-10 (August 2005)). As discussed in the memorandum, an intent of the policy "is to maintain and protect high quality waters and not to allow for any degradation beyond a *de minimis* level without having made a demonstration, with opportunity for public input, that such lowering is necessary and important." (Memorandum at p. 1). U.S. EPA has determined that the significance threshold of a 10% reduction in available assimilative capacity is "workable and protective in identifying those significant lowering of water quality that should receive a full... antidegradation review, including public participation." (U.S. EPA, 2005). This determination by U.S. EPA is helpful in determining the magnitude of water quality change that is determined to be of significant interest in the antidegradation analysis.

2.3 State Policies and Guidance

2.3.1 Resolution 68-16

The State issued its own antidegradation policy in 1968 to protect and maintain existing water quality in California. The State's Resolution 68-16 is interpreted to incorporate the federal antidegradation policy and satisfies the federal regulation requiring states to adopt their own antidegradation policies. Resolution 68-16 states, in part:

- 1) *Whenever the existing quality of water is better than the quality established in policies as of the date on which such policies become effective, such existing high quality will be maintained until it has been demonstrated to the State that any change will be consistent with maximum benefit to the people of the State, will not unreasonably affect present and anticipated beneficial uses of such water and will not result in water quality less than that prescribed in the policies.*
- 2) *Any activity which produces or may produce a waste or increased volume or concentration of waste and which discharges or proposes to discharge to existing high quality water will be required to meet waste discharge requirements which will result in the best practicable treatment or control of the discharge necessary to assure that (a) a pollution or nuisance will not occur and (b) the highest water quality consistent with maximum benefit to the people of the State will be maintained.*

2.3.2 1987 Policy Memorandum

In 1987, SWRCB issued a policy memorandum to the Regional Water Quality Control Boards (Regional Water Boards) to provide guidance on the application of the federal antidegradation policy for State and Regional Water Board actions, including establishing water quality objectives, issuing NPDES permits, and adopting waivers and exceptions to water quality objectives or control measures (Attwater, 1987). In conducting these actions, the Regional Water Boards must assure protection of existing beneficial uses, that significant lowering of water quality is necessary to accommodate important economic or social development, and that outstanding national resource waters be maintained and protected. The 2005 U.S. EPA guidance referenced in the Federal Policies and Guidance Section above is useful in determining whether changes in water quality that may result from a proposed action are significant.

2.3.3 Administrative Procedures Update (APU) 90-004

SWRCB issued guidance (APU 90-004) to all Regional Water Boards in 1990 regarding the implementation of State and federal antidegradation policies in NPDES permits. By using this guidance, Regional Water Boards are to determine if a proposed discharge is consistent with the intent and purpose of the State and federal antidegradation policies. APU 90-004 provides Regional Water Boards with guidance on the appropriate level of analysis that may be necessary, distinguishing between the need for a "simple" antidegradation analysis and a "complete" antidegradation analysis. If it is determined that a simple analysis is not appropriate based on the estimated level of impact of the new discharge, then a more rigorous analysis – a complete analysis – is appropriate. A primary focus of the complete analysis is the determination of whether and the degree to which water quality is lowered as compared to the socioeconomic costs of maintaining existing water quality. This determination greatly influences the level of analysis required and the level of scrutiny applied to the "balancing test" – that is, whether the discharge is necessary to accommodate important economic and social development, and whether a water quality change is consistent with the maximum benefit to the people of the State.

The antidegradation analysis addresses the following questions stated in SWRCB APU 90-004 to maintain consistency with State and federal antidegradation policies.

- Whether a reduction in water quality will be spatially localized or limited with respect to the water body; e.g., confined to the mixing zone;
- Whether the proposed discharge of treated effluent will produce minor effects which will not result in a significant reduction of water quality;

- Whether the proposed discharge of treated effluent has been approved in a General Plan, or similar growth and development policy document, and has been adequately subjected to the environmental analysis required in an environmental impact report (EIR) required under the California Environmental Quality Act (CEQA); and
- Whether the proposed Project is consistent with maximum benefit to the people of the State.

The Replenish Big Bear Program seeks to discharge highly treated effluent receiving RO treatment and UV disinfection to the Lake and to Shay Pond. BBARWA has reviewed the NPDES guidance issued by SWRCB in APU 90-004 and believes that the proposed project meets the criteria for a simple antidegradation analysis. The following sections provide the rationale for this determination and an associated level of analysis and information for use by the Regional Water Board in its consideration of state and federal antidegradation requirements in accordance with APU 90-004.

3 APPLICABLE WATER QUALITY STANDARDS

This section summarizes the applicable water quality standards for Stanfield Marsh and the Lake. Stanfield Marsh and the Lake are both waters of U.S., which have several designated beneficial uses. Water quality standard applicable to Shay Pond are discussed in **Section 6**. **Figure 5** shows the proposed discharge location in reference to Stanfield Marsh and Lake.

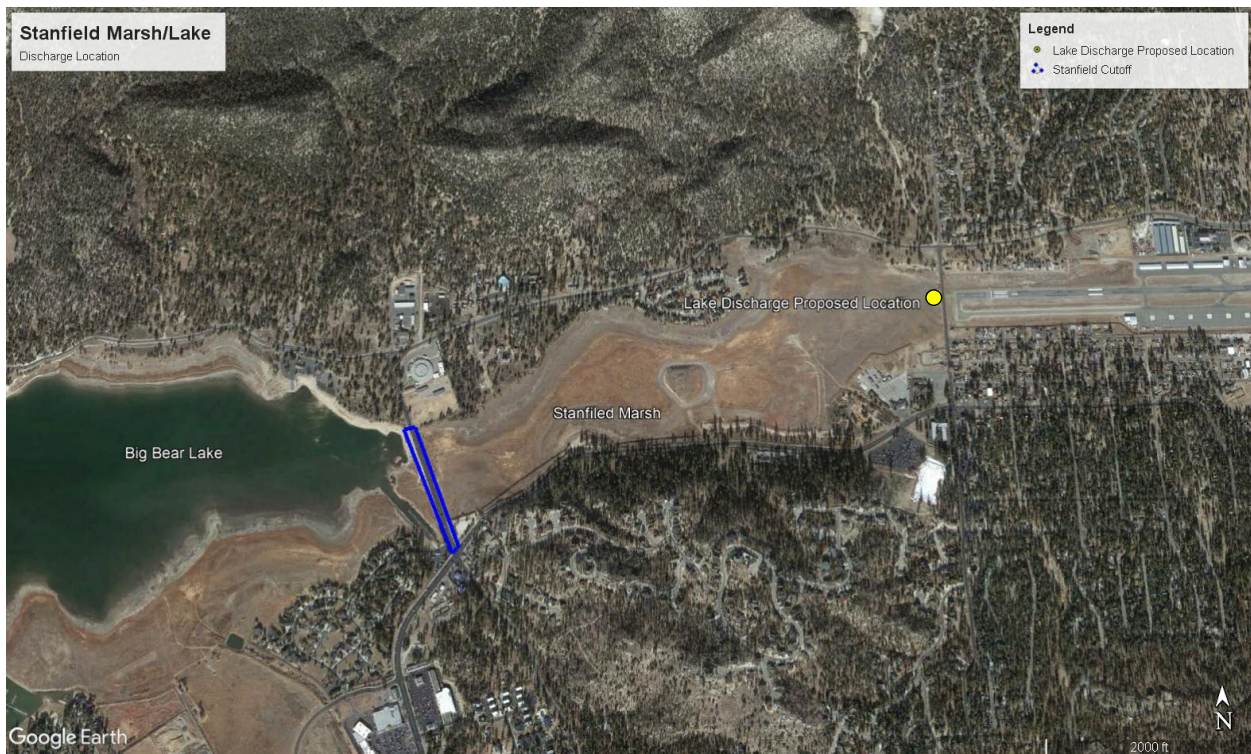

Figure 5. Overview of Lake Discharge Location in Reference to Stanfield Marsh/Lake

3.1 Beneficial Uses

The Basin Plan contains descriptions of the legal, technical, and programmatic bases for water quality regulation in the Santa Ana region. The Basin Plan describes the beneficial uses of major surface waters and their tributaries and the corresponding WQOs put into effect to protect these beneficial uses. **Table 1** shows the designated beneficial uses of the Lake and Stanfield Marsh.

Table 1. Beneficial Uses of Lake and Stanfield Marsh

Beneficial Uses	Big Bear Lake	Stanfield Marsh
AGR - Agricultural Supply	✓	
COLD - Cold Freshwater Habitat	✓	✓
GWR - Groundwater Recharge	✓	
MUN - Municipal and Domestic Supply	✓	✓
RARE - Rare, Threatened, or Endangered Species	✓	✓
REC1 - Water Contact Recreation	✓	✓
REC2 - Non-Contact Water Recreation	✓	✓
SPWN - Spawning, Reproduction, and/or Early Development	✓	
WARM - Warm Freshwater Habitat	✓	
WILD - Wildlife Habitat	✓	✓

3.2 Water Quality Objectives/Water Quality Criteria

To protect the designated beneficial uses, the Regional Water Board applies WQOs contained in the Basin Plan and criteria adopted in the California Toxics Rule (CTR) and the National Toxics Rule (NTR) to the receiving water (i.e., Lake) and downstream receiving waters (i.e., Bear Creek and subsequently Santa Ana River Reach 6). Per the Basin Plan, Stanfield Marsh does not have numeric WQOs. The Lake WQO objectives were used since these are more stringent and the Stanfield Marsh has been mostly dry since 2015.

The Regional Water Board uses these standards to determine if a proposed project will cause or contribute to impairments of the designated beneficial uses. **Table 2** presents the most conservative water quality criteria used to protect the most sensitive beneficial uses that apply to the Lake and downstream receiving waters. The constituents of interest included in **Table 2** are those:

- Included in the Basin Plan;
- Listed in the California 2018 Integrated Report for CWA Section 303(d) list;
- Identified by the Regional Water Board as pollutants of particular concern; and

Antidegradation Analysis for Proposed Discharges to Stanfield Marsh/Big Bear Lake and Shay Pond

- Constituents for which a Total Maximum Daily Load (TMDL) exists.

Table 2. Applicable WQOs and/or Criteria for the Lake Discharge

Constituent	Most Stringent WQO or Criterion	Unit	Reference for Most Stringent WQO or Criterion
Ammonia as N	0.46	mg/L	Basin Plan; used Basin Plan Table 4-4 ^(a)
Boron, Total	0.75	mg/L	Basin Plan ^(b)
Chloride	10	mg/L	Basin Plan
Fluoride	0.9	mg/L	Basin Plan ^(c)
Hardness, Total (as CaCO ₃)	125	mg/L	Basin Plan
Methylene Blue-Activated Substances	0.05	mg/L	Basin Plan ^(d)
Sodium	20	mg/L	Basin Plan
Sulfate	10	mg/L	Basin Plan
Total Dissolved Solids	175	mg/L	Basin Plan
Total Inorganic Nitrogen	0.15	mg/L-N	Basin Plan
Total Nitrogen	1	mg/L-N	Regional Board Input ^(e)
Chlorophyll-a	14	µg/L	Nutrient TMDL
Total Phosphorus	35	µg/L-P	Nutrient TMDL
Chlordane	0.00057	µg/L	Lake CWA 303(d) List; CTR
4,4'-DDT	0.00059	µg/L	Lake CWA 303(d) List; CTR
PCBs	0.00017	µg/L	Lake CWA 303(d) List; CTR
Cadmium, Dissolved	2.2	µg/L	Santa Ana River Reach 6 CWA 303(d) List ^(f)
Copper, Dissolved	8.9	µg/L	Santa Ana River Reach 6 CWA 303(d) List ^(f)
Lead, Dissolved	2.5	µg/L	Santa Ana River Reach 6 CWA 303(d) List ^(f)
Mercury	10	ng/L	Lake CWA 303(d) List; Statewide Mercury Provisions
Aluminum	200	µg/L	Title 22 MCL ^(g)
Specific Conductance	700/1,000	µmhos/cm	AGR Beneficial Use Goal ^(g)

Notes: Bolded constituents were identified as constituents of interest by the Regional Water Board and were modeled in the Lake Analysis (**Appendix B & C** and discussed in **Section 5.3.1**.)

- a) The total ammonia was estimated using the equation presented in Table 4-4 of the Basin Plan. The Lake wide average pH is 8.28 based on the 2009-2019 TMDL data collected. The Lake water temperature ranges between 35 °F (1.8°C) and 70°F (20.7°C). The average Lake water temperature used is 53°F (11.8°C).
- b) Boron concentrations shall not exceed 0.75 mg/L in inland surface waters of the region as a result of controllable water quality factors.

Antidegradation Analysis for Proposed Discharges to Stanfield Marsh/Big Bear Lake and Shay Pond

Constituent	Most Stringent WQO or Criterion	Unit	Reference for Most Stringent WQO or Criterion
c) Annual average concentration determined based on daily air temperature between 17.7-21.4 °C. d) MBAS concentrations shall not exceed 0.05mg/L in inland surface waters designated MUN as a result of controllable water quality factors. It is a secondary drinking water standard. e) Value is being considering by the Regional Water Board, as potential target. f) California Toxics Rule (CTR) hardness-based criterion continuous concentration (CCC) calculated using a median total hardness value of 99 mg/L calculated from measurements made in the Santa Ana River, Reach 6, upstream of Seven Oaks Dam, 2000-2006. g) Constituent added as it was detected in the secondary effluent and Lake.			

The Basin Plan contains both numeric and narrative objectives for inland surface waters, which were used to evaluate the Lake discharge. For this analysis, some of the narrative objectives were not evaluated for the following reasons:

- Algae, floatable, oil and grease, solids (suspended and settleable), sulfides, and surfactants were not evaluated because the Basin Plan does not specify numeric limits so these parameters could not be compared;
- Chlorine residual because chlorine will not be used for disinfection at the BBARWA WWTP;
- Chemical oxygen demand , dissolved oxygen, pathogen indicator bacteria, radioactivity material, color, temperature, and taste and odor because these are assumed to be non-conservative constituents (i.e., presumed to be destroyed, consumed, biodegraded or transformed through the treatment process or through Stanfield Marsh). The treatment process includes low- and high-pressure membrane systems capable of producing effluent that meets or exceeds the objectives for inland surface waters for these constituents, to be confirmed with site-specific piloting of the treatment process;
- Nitrate as N since the TN value being considered by the Regional Board is more stringent than the recommended 10 mg/L in Basin Plan; and
- pH because the treatment process maintains a neutral pH between 7 and 8 upstream of the reverse osmosis process, and then become slightly acidic downstream of reverse osmosis. Reverse osmosis chemical post-treatment will be employed to adjust the pH to a neutral level such that the effluent is within the numerical objectives for pH. In general, the pH of inland surface waters shall not be raised above 8.5 or depressed below 6.5 as a result of controllable water quality factors.

3.3 303 (d) Listings

Section 303(d) of the CWA requires states to develop lists of water bodies (or segments of water bodies) that will not attain water quality standards after implementation of minimum required levels of treatment by point-source dischargers (i.e., municipalities and industries). Section 303(d) requires states to develop a TMDL for each of the listed pollutant and water body combinations for which there is impairment. A TMDL is the amount of loading that the water body can receive and still meet water quality standards for that pollutant. The TMDL must include an allocation of allowable loadings for both point and non-point sources, with consideration of background loadings and a margin of safety. NPDES permit limitations for listed pollutants must be consistent with allocations identified in adopted TMDLs.

The U.S. EPA approved the California's 2018 Integrated Report for CWA Sections 305 (b) and 303(d) on June 9, 2021 (SWRCB, 2021). This list represents the most current listing of impaired water bodies in the project area and downstream areas. The Lake is included in the California's 2018 Section 303(d) list of impaired water bodies for mercury, nutrients, noxious aquatic plants, dichlorodiphenyltrichloroethane (DDT), chlordane, and polychlorinated biphenyls (PCBs). The Santa Ana River (SAR) Reach 6, which is located about 17 miles downstream from the Lake, is also listed for cadmium, lead, and copper. The potential water quality impacts of the proposed Lake discharge are discussed in **Section 5**.

Table 3 lists the constituents identified in the 2018 303(d) list for the Lake and SAR Reach 6, and their potential sources and proposed TMDL completion dates.

Table 3. 2018 CWA Section 303(d) Listed Constituents

Pollutant/Stressor	Potential Sources	Proposed TMDL Adoption
Lake		
Mercury	Source Unknown	2007
Nutrients	Construction/Land Development	Completed
Noxious aquatic plants	Source Unknown	Completed
DDT	Source Unknown	2027
Chlordane	Source Unknown	2027
PCBs	Source Unknown	2019
Santa Ana River Reach 6		
Cadmium	Source Unknown	2021
Lead	Source Unknown	2021
Copper	Source Unknown	2021

3.4 Lake Nutrient TMDL

The Big Bear Lake Nutrient Total Maximum Daily Load (Nutrient TMDL) for Dry Hydrologic Conditions (Resolution No. R8-2006-0023) was adopted by the Regional Water Board on April 21, 2006 and became effective on September 25, 2007. The Nutrient TMDL includes targets in the Lake for TP, macrophyte coverage, nuisance aquatic vascular plant species, and chlorophyll-a. **Table 4** shows the Nutrient TMDL targets. TP is the only constituent that would be directly discharged and controlled by BBARWA.

Table 4. Nutrient TMDL Numeric Targets for All Hydrologic Conditions

Indicator	Target Value ^{(a)(b)}
TP Concentration ^(c)	Annual average no greater than 35 µg/L
Macrophyte Coverage ^(d)	30-40% on a total lake area basis
Percentage of Nuisance Aquatic Vascular Plant Species ^{(d)(e)}	95% eradication on a total area basis of Eurasian Water milfoil and any other invasive aquatic plant species
Chlorophyll-a Concentration ^(e)	Growing season average no greater than 14 µg/L

Source: Basin Plan

Notes:

- a) Targets to be attained no later than 2015 (dry hydrological conditions), 2020 (all other conditions)
- b) Compliance date for wet and/or average hydrological conditions may change in response to approved TMDLs for wet/average hydrological conditions.
- c) Annual average determined by the following methodology: the nutrient data from both the photic composite and discrete bottom samples are averaged by station number and month; a calendar year average is obtained for each sampling location by averaging the average of each month; and finally, the separate annual averages for each location are averaged to determine the lake-wide average.
- d) Calculated as a 5-yr running average based on measurements taken at peak macrophyte growth.
- e) Growing season is the period from May 1 through October 31 of each year. The chlorophyll-a data from the photic samples are averaged by station number and month; a growing season average is obtained for each sampling location by averaging the average of each month; and finally, the separate growing season averages for each location are averaged to determine the lake-wide average.

An analysis to demonstrate that the proposed Lake discharge is consistent with the Nutrient TMDL assumptions is provided in Attachment B of the ROWD package. This technical memorandum (TM) also discusses a TP offset framework to address the lack of wasteload allocation (WLA) for the proposed Lake discharge by proposing a TP net zero load. The TM also discusses the effects of the Lake discharge and TP Offset Program on chlorophyll-a, the response target, as documented in the Lake Analysis (**Appendix B**) and new model updates (**Appendix C**).

3.5 Statewide Mercury Provisions

On May 2, 2017, the California State Water Resources Control Board (State Water Board) adopted Resolution 2017-0027, which approved "*Part 2 of the Water Quality Control Plan for Inland Surface Waters, Enclosed Bays, and Estuaries of California—Tribal and Subsistence Fishing Beneficial Uses and Mercury Provisions.*" Resolution 2017-0027 established mercury limits to protect the beneficial uses associated with the consumption of fish by both people and wildlife. For lakes and reservoirs, the mercury water column concentration is to be calculated by the permitting authority (i.e., Regional Water Board). The mercury limit for the Lake has not yet been established. However, the State Water Board is also developing a Statewide Mercury Control Program for Reservoirs that are impaired for mercury. The draft "*2017 Amendment to the Water Quality Control Plan for Inland Surface Waters, Enclosed Bays, and Estuaries of California—Mercury TMDL and Implementation Program for Reservoirs,*" proposes to establish WLAs of 10 ng/L for major WWTPs (permitted flow >1 MGD), and a WLA of 20 ng/L for facilities with no "upstream" dischargers. The Statewide Mercury Provisions identified the Lake as one of the 131 impacted reservoirs. For this analysis, the 10 ng/L WLA was considered for evaluation with respect to potential water quality impacts due to the proposed Lake discharge.

3.6 Title 22 Recycled Water Criteria

Per conversations with DDW, the Lake may be designated as a non-restricted recycled water impoundment and the subsequent use of Lake water for snowmaking, landscape irrigation, construction uses, and groundwater recharge would be subject to recycled water regulations. Additional coordination and studies are being conducted to regulate these uses. It is anticipated that a separate WDR permit will be obtained to regulate the Sand Canyon groundwater recharge project. The non-potable recycled water uses for landscape irrigation, construction uses, snowmaking, and nonrestricted impoundment are anticipated to be regulated under the Statewide Water Reclamation Requirements for Recycled Water Use (Oder WQ 2016-0068-DDW).

4 ENVIRONMENTAL SETTING

This section provides additional context to understand the environmental setting for the Lake discharge.

4.1 Stanfield Marsh

As part of Replenish Big Bear, the proposed project will discharge to the east end of Stanfield Marsh, then flow into the Lake, as shown in **Figure 5**.

Stanfield Marsh is a scenic 145-acre nature park that includes a gazebo, walking paths, and two boardwalks that extend out into the marsh, so visitors can observe the wildlife. Stanfield Marsh is home to rare and diverse species of birds, fish, amphibians, and mammals. Rainfall and snowmelt are the only sources of water for Stanfield Marsh, so the water level varies from season to season. During wet periods, Stanfield Marsh is a thriving wildlife preserve. During extended drought conditions, the water level recedes dramatically, the boardwalks extend over dry soil, and presence of wildlife becomes scarce. In the last 15 years, Stanfield Marsh has been less than half full nearly 40 percent of the time.



4.2 Big Bear Lake

Stanfield Marsh is hydrologically connected to the Lake through a set of culverts under Stanfield Cutoff. The Lake is located about 6,743 feet (ft; 2,055 meters) above mean sea level (MSL) in the San Bernardino Mountains in San Bernardino County. Together, Stanfield Marsh and the Lake have a surface area of approximately 3,000 acres, a storage capacity of 73,320 AF, and an average depth of 32 ft. The Lake's sole source of water is currently snowmelt and stormwater runoff, which are highly variable. The Lake has several sources of water loss including evaporation, water extraction for snow making, dam releases for flood control, fishery protection, and water rights discharges.

The Lake was formed following construction of the Bear Valley Dam in 1883-1884 to serve as an irrigation supply for the citrus industry in the downstream Redlands-San Bernardino communities. BBMWD was formed in 1964 to manage and help stabilize the water level in the Lake. Historically, the Lake was operated as a storage reservoir by the Bear Valley Mutual Water Company (Mutual). However, due to the drastic fluctuations in Lake levels, legal negotiations arising from disagreement between Mutual, BBMWD, and the community of Big Bear Valley regarding water rights and management of the Lake, a 1977 Judgment was established. Under the terms of this court judgment, Mutual retains a storage right and ownership of all water inflow into the Lake. BBMWD is required to provide Mutual with up to 65,000 AF of water from the Lake in a 10-year rolling period.

In 1996, an In-Lieu Agreement was executed that allows BBMWD to maintain higher Lake levels by delivering water to Mutual from an alternate source of water. This alternate source of water, referred to as In-Lieu Water, comes mainly from the State Water Project (SWP) through the San Bernardino Valley Municipal Water District (SBVMWD), a State Water Contractor. Under the In-Lieu Agreement, when the Lake level falls more than 6 foot below full, and during some months when the Lake is between 4 and 6 feet below full, SBVMWD delivers SWP water to meet Mutual's needs instead of BBMWD releasing water from the Lake. BBMWD pays SBVMWD an annual fee that is adjusted each year based on property tax values.

Due to variable precipitation and extended drought, the Lake has experienced drastic changes in water levels, which impact its water quality. In December 2018, the Lake reached a historic low of 18'1" below full, which is less than 40% full by volume. **Figure 6** shows the fluctuation in Lake levels between 2000 and 2021.

The Lake is an important resource that provides extensive recreational, economic, ecological, and aesthetic benefits for the local community as well as the larger inland southern California region. The beneficial uses of the Lake and Marsh are presented in **Table 1**.

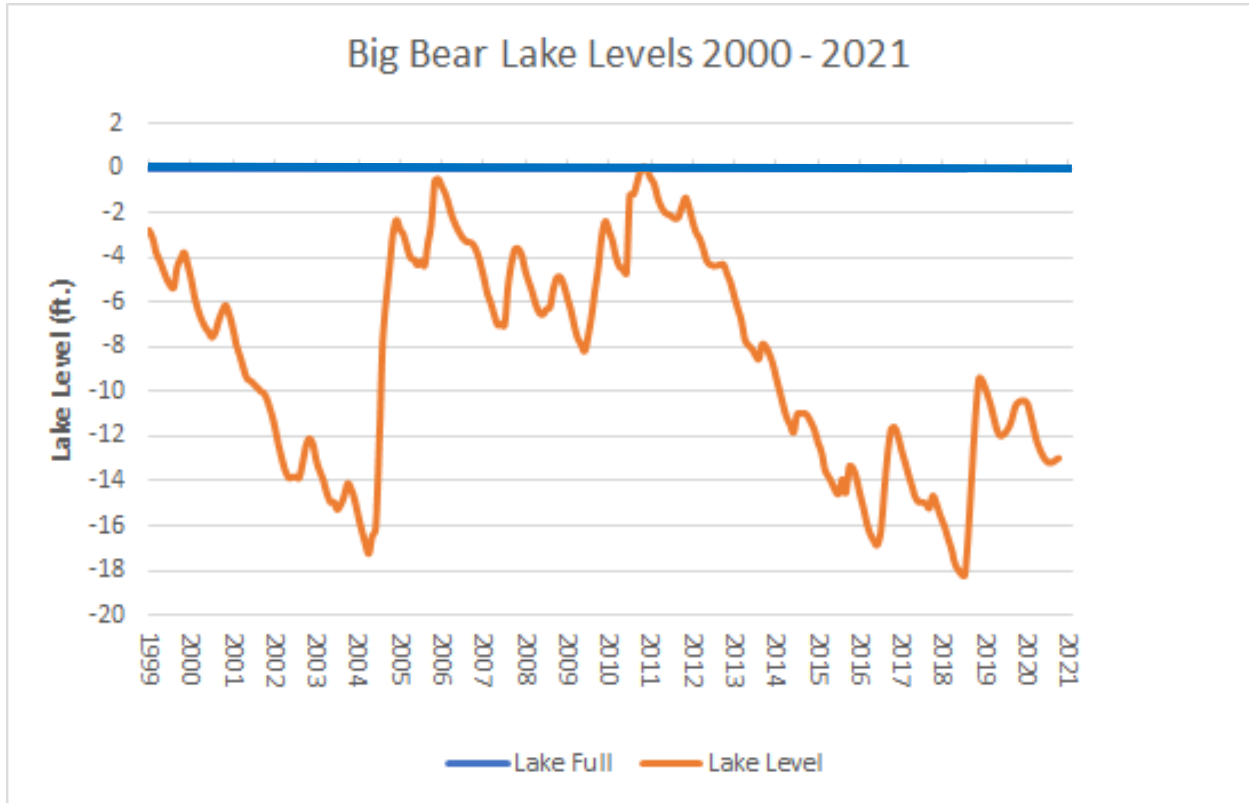

Figure 6. Big Bear Lake Levels: 2000 – 2021

4.3 Santa Ana Watershed

The Lake's dam releases are discharged to Bear Creek, a 17-mile stream, which enters the SAR at Reach 6. The Santa Ana River Watershed comprises portions of San Bernardino, Riverside, Los Angeles, and Orange Counties, covers an area of 2,840 square miles, and is home to over 6 million residents. The Santa Ana River is the major stream draining the watershed—about 100 miles in length from its headwaters near Big Bear to its discharge location in Huntington Beach. **Figure 7** shows the Santa Ana River Watershed, along with the Santa Ana River and its major tributaries.

5 ASSESSMENT OF WATER QUALITY IMPACTS TO BIG BEAR LAKE

This section summarizes the water quality assessment methodology and results for the proposed Lake discharge and potential associated impacts in downstream receiving waters.

5.1 Lake Discharge Project Description

As discussed in **Section 1**, one of the project components of the Replenish Big Bear Program is to discharge to the Lake disinfected, advanced treated effluent that has undergone RO and UV treatment. The Lake discharge is intended to help stabilize Lake levels especially during extended drought periods, assist to maintain the beneficial uses of the Lake, and reduce the in-lieu SWP water demands if higher lake levels allow for additional dam releases. The Lake has experienced record low levels over the last 15 years, forcing BBMWD to close one of their two boat ramps, which reduces the recreational benefit of the Lake.

The projected effluent quality of the proposed discharge is presented in **Table 5** for the constituents of interest in this study (constituents of interest are those listed in **Table 2**). Site-specific pilot testing of the proposed treatment process technologies will be completed in 2023 to establish design criteria and refine final effluent water quality estimates. The values presented in **Table 5** are based on mass balance calculations, vendor provided treatment performance estimates, and industry standard removal rates for RO treatment technology. The secondary effluent data were used as a basis for influent water quality to the advanced treatment train to estimate the projected effluent water quality for the proposed discharge.

Table 5. Projected Effluent Quality of Proposed Discharge and Existing Secondary Effluent Quality

Constituent	BBARWA Secondary Effluent Average Concentrations ^(a)	Projected Average Effluent Quality of Proposed Discharge	Unit
Ammonia as N	3.15	0.05	mg/L-N
Boron, Total	0.265	0.11	mg/L
Chloride	58	0.60	mg/L
Fluoride	0.41	<0.026 ^(b)	mg/L
Hardness, Total (as CaCO ₃)	265	3.2	mg/L
Methylene Blue-Activated Substances	0.14	0.0014	mg/L
Sodium	NS	1.9	mg/L
Sulfate	41	0.20	mg/L
Total Dissolved Solids ^(c)	450	50	mg/L
Total Inorganic Nitrogen ^(c)	4.40	0.1	mg/L-N
Total Nitrogen ^(c)	7.80	0.6	mg/L-N
Chlorophyll-a ^(d)	N/A	N/A	µg/L
Total Phosphorus ^(c)	2.0	0.03	mg/L-P
Chlordane	<0.17 ^(e)	<0.17 ^{(b)(e)}	µg/L
4,4'-DDT	<0.0052 ^(e)	<0.0052 ^{(b)(e)}	µg/L
PCBs	<2.5 ^(e)	<2.5 ^{(b)(e)}	µg/L
Cadmium, Total	<0.11	<0.11 ^(b)	µg/L
Copper, Total	14 ^(f)	0.07	µg/L
Lead, Total	1.3	0.01	µg/L
Mercury, Total	0.76 ^(g)	<0.5 ^(b)	ng/L
Aluminum, Total	180	1.3	µg/L
Specific Conductance	755 ^(e)	18	µmhos/cm

Notes: NS – Not sampled; N/A – Not applicable.

- a) The average was estimated using detected values only, unless stated otherwise. NDs were not included due to the limited number of samples. This approach may result in higher averages.
- b) The projected effluent quality is anticipated to be below the detection limit. The estimated projected concentration is shown as "<MDL".
- c) Values were estimated as part of Draft Treatment Alternatives Analysis TM using BBARWA WWTP average effluent concentrations from weekly and monthly analyses for the 2017 - 2019 calendar years (WSC, 2020).
- d) Chlorophyll-a is not a constituent that will be discharged by the BBARWA WWTP.
- e) Based on one data point.
- f) Values detected below the RL; reported concentration is estimated. Reported as "J-Flag."

Constituent	BBARWA Secondary Effluent Average Concentrations ^(a)	Projected Average Effluent Quality of Proposed Discharge	Unit
g) On June 18, 2020, BBARWA collected a sample to measure mercury using EPA Method 1631E, which has a reporting limit of 0.5 ng/L. This result is well below the 10 ng/L target described in the Statewide Mercury Control Program for Reservoirs.			

5.2 Selection of Water Quality Constituents

5.2.1 Selection Criteria

As presented in **Section 3**, water quality constituents assessed in this antidegradation analysis were identified based on one or more of the following conditions being satisfied:

- 1) Constituent has a WQO or criterion applicable to the Lake and/or downstream receiving waters;
- 2) Constituent for which an adopted TMDL exists;
- 3) Constituent identified as a pollutant/stressor on the 2018 CWA Section 303(d) list for the Lake or downstream of the proposed discharge; and
- 4) Constituent is a known water quality concern of the Regional Water Board.

Based on the conditions listed above, 22 constituents of interest were initially identified for evaluation and are presented in **Table 2**. The data available for the secondary effluent, proposed discharge effluent quality, and ambient water quality were assessed to determine the type of analysis needed for a given constituent. The following approach was used:

- No further analysis was needed for constituents reported as non-detect (ND) in the secondary effluent and the Lake. It is anticipated that RO treatment will achieve additional removal of these constituents and thus, will further reduce any water quality impacts potentially associated with these constituents.
- For constituents with detected concentrations in the secondary effluent, the proposed discharge water quality was compared to the ambient water quality and most stringent WQO or criterion.
- For the proposed discharge water quality constituents exceeding the ambient water quality or most stringent WQO or criterion, a mass balance analysis was completed.

- For constituents of greater interest to the Regional Water Board, such as TIN, TN, TP, and chlorophyll-a, the 2D hydrodynamic-water quality model (CE-QUAL-W2) developed by Dr. Anderson was used to evaluate the potential impacts of the proposed Lake discharge. A summary of the Lake Analysis (**Appendix B**) report along with the model updates recently completed to incorporate additional discharge volume scenarios and seasonal variability are presented in this report and in **Appendix C**.

5.2.2 Data Sources

Table 6 shows the water quality data used for the analysis. Per BBARWA's current WDR Permit, BBARWA is required to monitor for biological oxygen demand (BOD), total suspended solids (TSS), pH, dissolved oxygen (DO), TDS, sulfate, chloride, fluoride, nitrate as N, TN, E.coli, and volatile organic compounds (VOCs) in the secondary effluent on a monthly or annual basis. To support the preparation of the proposed project's Report of Waste Discharge (ROWD) and this analysis, water samples of the secondary effluent and Lake were collected and analyzed for priority pollutants. BBARWA collected its samples on November 18, 2021, and BBMWd collected the Lake samples on December 2, 2021. On June 18, 2020, BBARWA also collected a secondary effluent sample to measure mercury using EPA Method 1631E, which has a reporting limit of 0.5 ng/L. **Appendix D** contains the BBARWA, Lake, and Shay Pond (discussed in **Section 6**) water quality data.

As part of the Nutrient TMDL, a variety of constituents, including ammonia as N, total hardness, nitrate as N, nitrite as N, total kjeldahl nitrogen (TKN)², TP, and chlorophyll-a are collected at the four TMDL monitoring locations (Station 1 Dam, Station 2 Gilner Point, Station 6 Mid Lake Middle, and Station 9 Stanfield Middle. (See **Figure 2** in **Appendix B**). In the Lake Analysis, TIN³, TN⁴, TP, and chlorophyll-a were evaluated using the Nutrient TMDL data from 2009 through 2019. The average results calculated in the Lake Analysis are presented in **Table 6**.

Ammonia and hardness were not modeled in the Lake Analysis because these were not identified as constituents of interest at the time of the model development. For this analysis, the lake-wide annual average was estimated by averaging the four station annual averages consistent with the Nutrient TMDL approach, which consist of averaging the photic and bottom samples for each sampling date. From 2009 through 2019, about 1,280 and 1,180 data points were collected for ammonia and hardness, respectively, at these locations. The calculations are presented in **Appendix E**.

² TKN is the sum of organic nitrogen and ammonia.

³ TIN is the sum of ammonia, nitrate, and nitrite.

⁴ TN is defined as the sum of TKN, nitrite, and nitrate.

BBMWD also has manually recorded specific conductance data since 2001 measured at the first 10 to 15 feet below Lake surface. The specific conductance data was used to evaluate TDS in the Lake Analysis as specific conductance can be converted to TDS using a conversion factor that is dependent on the type of minerals and salts dissolved in the Lake. In August 2019, BBMWD collected TDS samples at the four TMDL monitoring locations to compare TDS and specific conductance results and calculated a conversion factor of 1 mg/L of TDS = 0.642 $\mu\text{mhos/cm}$, which was used in the Lake Analysis model. The Lake TDS average from this report was converted to $\mu\text{mhos/cm}$ using this conversion factor.

Table 6. Summary Statistics for Constituents Evaluated in Secondary Effluent and Big Bear Lake

Constituent	Unit	BBARWA Secondary Effluent ^(a)				Big Bear Lake ^(a)			
		No. of Samples	% Non-Detected	Avg. ^(b)	Max.	No. of Samples	% Non-Detected	Avg. ^(b)	Max.
Ammonia as N	mg/L	24	29%	3.15	22	1,281	33%	0.063 ^(c)	0.094
Boron, Total	mg/L	2	0%	0.265	0.270	1	0%	0.054 ^(d)	0.054 ^(d)
Chloride	mg/L	25	0%	58	63	1	0%	26	26
Fluoride	mg/L	2	0%	0.41	0.52	1	0%	0.41	0.41
Hardness, Total (as CaCO ₃)	mg/L	2	0%	265	270	1,176	0%	157 ^(c)	183
MBAS	mg/L	2	50%	0.14	0.14	1	0%	0.058 ^(d)	0.058 ^(d)
Sodium	mg/L	0	NS	NS	NS	1	0%	33	33
Sulfate	mg/L	20	0%	41	44	1	0%	18	18
Total Dissolved Solids	mg/L			450 ^(e)				251 ^(f)	
Total Inorganic Nitrogen	mg/L			4.40 ^(e)				0.049 ^(f)	
Total Nitrogen	mg/L			7.80 ^(e)				0.948 ^(f)	
Chlorophyll-a	µg/L			N/A				9.3 ^(f)	
Total Phosphorus	mg/L			2.00 ^(d)				0.037 ^(f)	
Chlordane	µg/L	1	100%	<0.17	<0.17	1	100%	<0.034	<0.034
4,4'-DDT	µg/L	1	100%	<0.0052	<0.0052	1	100%	<0.001	<0.001
PCBs (Aroclors) ^(g)	µg/L	1	100%	<2.5	<2.5	1	100%	<0.5	<0.5
Cadmium, Total	µg/L	8	100%	<0.11	<0.11	1	100%	<0.11	<0.11
Copper, Total	µg/L	8	88%	14 ^(d)	14 ^(d)	1	100%	<6.5	<6.5
Lead, Total	µg/L	8	75%	1.3	1.8 ^(d)	1	100%	1.8 ^(d)	1.8 ^(d)
Mercury, Total	ng/L	8	100%	0.76 ^(h)	0.76 ^(h)	2	50%	270	270
Aluminum, Total	µg/L	2	0	180	250	1	0%	58	58
Specific Conductance	µmhos/cm	1	0	755	755			391 ⁽ⁱ⁾	

Notes: Bolded constituents were identified as constituents of interest by the Santa Ana Regional Water Board and were modeled in the Lake Analysis (**Appendix B & C**).

Antidegradation Analysis for Proposed Discharges to Stanfield Marsh/Big Bear Lake and Shay Pond

NS – Not sampled; N/A – Not applicable.

- a) For constituents with only ND data, the method of detection limit (MDL) is shown as “<MDL.”
- b) The average was estimated using detected values only, unless stated otherwise. NDs were not included due to the limited number of samples. This approach may result in higher averages. For samples with only one data point, the reported value or “<MDL” is presented.
- c) The averages and maximums are for the Lake-wide results and were calculated using Nutrient TMDL 2009-2019 data. See **Appendix E** – for estimates. ND were used and assumed to be “MDL/2”.
- d) Values detected below the RL; reported concentration is estimated. Reported as “J-Flag.”
- e) Values were estimated as part of Draft Treatment Alternatives Analysis TM using BBARWA WWTP average effluent concentrations from weekly and monthly analyses for the 2017 - 2019 calendar years (WSC, 2020).
- f) TDS average was obtained from the Lake Analysis Table 19, and nutrients and chlorophyll-a from the Lake Analysis Table 22 (**Appendix B**).
- g) PCBs are a class of chemicals which include Aroclors 1242, 1254, 1221, 1232, 1248, 1260, and 1016. The aquatic life criteria apply to the sum of the set of seven Aroclors. All results were non-detect.
- h) On June 18, 2020, BBARWA collected a sample to measure mercury using EPA Method 1631E, which has a reporting limit of 0.5 ng/L. This result is well below the 10 ng/L target described in the Statewide Mercury Control Program for Reservoirs.
- i) The Lake TDS average from the Lake Analysis report was converted to $\mu\text{mhos/cm}$ using a $1 \text{ mg/L of TDS} = 0.642 \mu\text{mhos/cm}$ conversion factor.

5.2.3 Selection of Constituents

The simple qualitative analysis described in **Section 5.2.1** was applied to the 22 constituents of interest to determine if additional analysis was required. **Table 7** shows the results of the comparison of the secondary effluent quality, projected effluent quality, ambient water quality, and the most stringent WQO or criterion.

Overall, no constituents exceeded their most stringent WQO or criterion and only boron and TIN exceeded existing, ambient water quality concentrations. For the remainder of the constituents—where the projected effluent quality is below the ambient water quality and the most stringent WQO or criterion—no additional analysis was conducted.

The Lake Analysis evaluated TDS, TIN, TN, TP, and chlorophyll-a, so potential TIN water quality impacts were addressed by the Lake Analysis. For boron, a simple mass balance spreadsheet model was used to evaluate the potential impacts of boron on the Lake with the proposed project due to the limited data available.

With respect to the three trace metals – cadmium, copper, and lead – included in the 2018 303(d) list for Reach 6 of the SAR as impairing the water body segment, projected average concentrations of the three trace metals in the proposed discharge are significantly below the hardness-based CTR chronic criterion calculated for each metal using a median total hardness value of 99 mg/L calculated for Reach 6 (see **Table 2**). Cadmium, copper, and lead concentrations contained in the disinfected, advanced treated effluent proposed for discharge to the Lake are not anticipated to lower water quality in Reach 6 for these trace metals, nor are they anticipated to affect future load or WLA included in an adopted TMDL.

Antidegradation Analysis for Proposed Discharges to Stanfield Marsh/Big Bear Lake and Shay Pond

Table 7. Comparison of Most Stringent Water Quality Objective or Criterion to Existing Ambient Lake Water Quality and Projected Effluent Quality of Proposed Discharge

Constituent	Unit	Most Stringent WQO or Criterion	Average Lake Concentration ^{(a) (b)}	Projected Average Effluent Quality of Proposed Discharge ^(c)	Comparison of Projected Effluent Quality to Most Stringent WQO (see table Notes)
Ammonia as N	mg/L	0.46	0.063 ^(d)	0.05	1
Boron, Total	mg/L	0.75	0.054 ^(e)	0.11	2
Chloride	mg/L	10	26 ^(e)	0.60	1
Fluoride	mg/L	0.9	0.41 ^(e)	<0.026	1
Hardness, Total (as CaCO ₃)	mg/L	125	157 ^(d)	3.2	1
MBAS	mg/L	0.05	0.058 ^(e)	0.0014	1
Sodium	mg/L	20	33 ^(e)	1.9	1
Sulfate	mg/L	10	18 [€]	0.20	1
Total Dissolved Solids	mg/L	175	251	50	3
Total Inorganic Nitrogen	mg/L	0.15	0.049	0.1	2,3
Total Nitrogen	mg/L	1	0.948	0.6	3
Chlorophyll-a	µg/L	14	9.3	N/A	3
Total Phosphorus	mg/L	0.035	0.037	0.03	3
Chlordane	µg/L	0.00057	<0.034 ^(e)	<0.17	4
4,4'-DDT	µg/L	0.00059	<0.001 ^(e)	<0.0052	4
PCBs	µg/L	0.00017	<0.5 ^(e)	<2.5	4
Cadmium, Total	µg/L	2.2	<0.11 ^(e)	<0.11	4
Copper, Total	µg/L	8.9	<6.5 ^(e)	0.07	1
Lead, Total	µg/L	2.5	1.8 ^(e)	0.01	1
Mercury, Total	ng/L	10	270	<0.5	1
Aluminum, Total	µg/L	200	58 ^(e)	1.3	1

Antidegradation Analysis for Proposed Discharges to Stanfield Marsh/Big Bear Lake and Shay Pond

Constituent	Unit	Most Stringent WQO or Criterion	Average Lake Concentration ^(a) ^(b)	Projected Average Effluent Quality of Proposed Discharge ^(c)	Comparison of Projected Effluent Quality to Most Stringent WQO (see table Notes)
Specific Conductance	µmhos/cm	700/1,000	391	18	1

Notes: Bolded constituents were identified as constituents of interest by the Regional Water Board and were modeled in the Lake Analysis (**Appendix B & C**).

N/A – Not applicable.

- a) For constituents with only ND data, the method of detection limit (MDL) is shown as “<MDL.”
- b) The average was estimated using detected values only, unless stated otherwise. NDs were not included due to the limited number of samples. This approach may result in higher averages. For samples with only one data point, the reported value or “<MDL” is presented.
- c) If the projected effluent quality is anticipated to be below the detection limit. The estimated projected concentration is shown as “<MDL”.
- d) The averages and maximums are for the Lake-wide results and were calculated using Nutrient TMDL 2009-2019 data. See **Appendix E** – for estimates. ND were used and assumed to be “MDL/2”.
- e) Average is based on one data point.

Blue – Projected effluent quality is below the ambient and most stringent WQO or criterion

Red – Projected effluent quality is above the ambient or most stringent WQO or criterion

- 1) Projected effluent quality is below the ambient and most stringent WQO or criterion. No degradation anticipated.
- 2) Projected effluent quality is above the ambient, but below the most stringent WQO or criterion. Further analysis needed to determine impacts on water quality.
- 3) Impacts evaluated in the Lake Analysis (**Appendix B & C**).
- 4) Secondary effluent and ambient water quality were ND. No further analysis conducted. It is anticipated that RO will achieve additional removal, resulting in even fewer impacts.

5.3 Water Quality Impacts Assessment

5.3.1 Lake Analysis Model Analysis Results

The Lake Analysis (**Appendix B**) was completed to evaluate the short- and long-term impacts of the Lake discharge on lake level, lake area, TDS, TIN, TN, TP, and chlorophyll-a under three different treatment alternatives:

- Alternative 1: TIN & TP Removal
- Alternative 2: 70% RO (in addition to TIN & TP Removal)
- Alternative 3: 100% RO (in addition to TIN & TP Removal)

These treatment alternatives were evaluated under three hydrologic conditions (i.e., extended drought (5th percentile), median (50th percentile), and prolonged above average rainfall (95th percentile)). The model predicted that Alternative 3 would result in a slight improvement in concentrations of TDS, TIN, TN, TP, and chlorophyll-a as compared to modeled baseline conditions. Informed by the results of this study, the 100% RO treatment alternative was selected as the preferred project and the projected effluent quality of Alternative 3 is the focus of this antidegradation analysis.

Additional refinements to the Lake Analysis were completed in 2022, as documented in **Appendix C**, to investigate the impacts of a higher discharge volume, account for WWTP discharge seasonal variability, and assess the impacts of a TP Offset Program as discussed in **Section 3.4** and Attachment B of the ROWD package. The 50th percentile hydrologic scenario for 2009-2050 was used in the updated analysis (i.e., the median hydrologic condition), as it includes a wide array of runoff conditions. All other hydrologic, meteorological, biological, chemical, and sedimentological factors, variables and conditions were identical to those used in prior simulations of long-term future conditions (Anderson, 2021).

The Lake Analysis report assumed a steady annual flow of 1,920 AFY of disinfected, advanced treated effluent discharged to the Lake that excludes the 80 AFY that could be discharged to Shay Pond. However, the proposed Lake discharge may be higher than previously modeled as it did not account for a 99% total recovery rate of BBARWA effluent and potentially a lower discharge rate to Shay Pond. **Table 8** presents the Lake discharge flow projections that were considered in the Lake Analysis model and in the 2022 update.

Table 8. Initial and Updated Lake Discharge Flow Rate Projections

Lake Analysis Modeled Scenario	RBB Inflow (AFY)	Daily RBB Inflow (MGD)
Baseline (No Project)	0	0
Alternative 3 ^(a)	1,920	1.71
High Flow (99% recovery) ^(b)	2,210	1.57 – 2.18
Mid Flow (90% recovery) ^(b)	2,009	1.42 – 1.98

Notes:

- a) Alternative 3 was assessed in the 2021 Lake Analysis and assumed that of the total Replenish Big Bear effluent contribution considered in the Lake Analysis (i.e., 2,000 AFY), 80 AFY would be delivered to Shay Pond. Therefore, only 1,920 AFY would be discharged to the Lake.
- b) In the 2022 Lake Analysis update it was assumed that no discharge to Shay Pond would occur and all disinfected, advanced treated effluent would be discharged to the Lake under two different total recovery rates scenarios.

The Lake discharge is expected to vary seasonally, as shown in **Figure 8**, and thus, differs from the earlier “Alternative 3” scenario that assumed a uniform flow rate of 1.71 MGD throughout the year. Inflows to the WWTP are lower in the summer months due to reduced inflow and fewer visitors relative to the winter season.

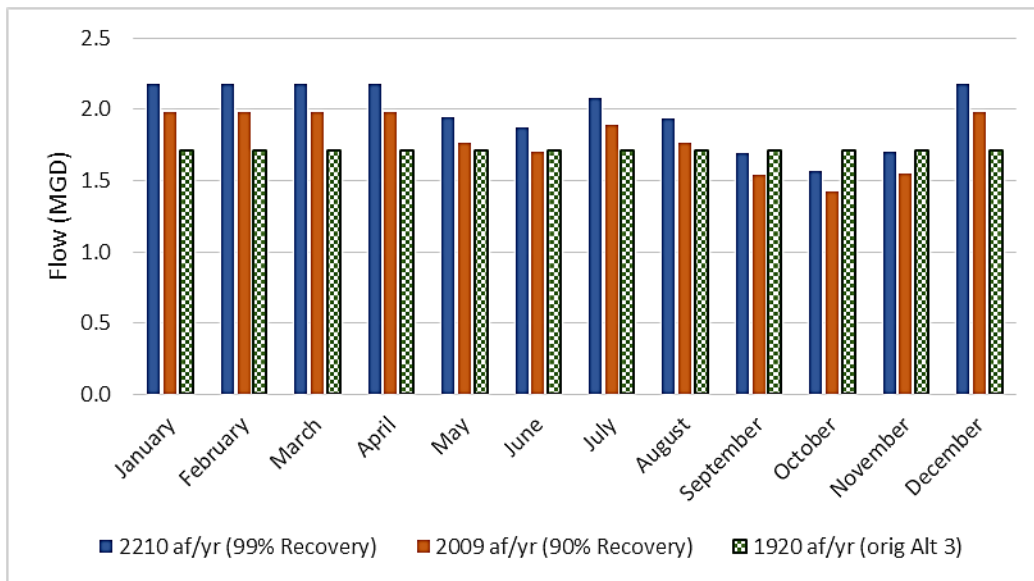

Figure 8. Projected 2040 Monthly BBARWA Discharges to the Lake under Three Inflow Scenarios

Since the Replenish Big Bear Program proposed Lake discharge has not been assigned a WLA for TP in the nutrient TMDL, a TP Offset Program is being proposed to attain a net zero TP contribution to be consistent with the Nutrient TMDL assumptions. A detailed analysis supporting the TP Offset Program is discussed in Attachment B of the ROWD package. In the Lake Analysis model update, the TP offset was modeled as equivalent to a 0 (zero) influent concentration. This approach is a simplification that may hold when considering a whole-lake nutrient budget. However, the Lake dynamics are complex, so projections may not have accounted for these complexities.

5.3.1.1 Lake Discharge Impacts Water Quality

The predicted long-term average water quality in the Lake under the updated modeled operational scenarios (increased and time-varying flows, with and without TP offset) are presented in **Table 9**. For comparison, the previously predicted baseline condition (no project) and Alternative 3 scenario are shown.

Table 9. Predicted Long-term Average Lake Concentrations for TDS, TIN, TN, TP, and Chlorophyll-a Under Different Operational Scenarios

Operational Scenario ^(a) (All at 50 th %tile hydrologic condition)	TDS ^(b) (mg/L)	TIN ^(b) (mg/L)	TP ^(b) (µg/L)	TN ^(b) (mg/L)	Chlorophyll-a ^(c) (µg/L)
WQO/(TMDL target)	175	0.15	0.15 (35.0)		(14.0)
Baseline (No Project)	195	0.069	47.7	1.15	14.1
Alternative 3 (1920 AFY)	182	0.052	43.3	1.07	14.0
2,210 AFY (99% recovery)	179	0.045	42.3	1.04	13.1
2,009 AFY (90% recovery)	180	0.041	43.4	1.06	12.9
2,210 AFY + TP Offset	179	0.072	39.9	1.00	10.2
2,009 AFY + TP Offset	180	0.040	40.9	1.00	9.5

Notes:

- a) The Baseline and Alternative 3 were evaluated in the 2021 Lake Analysis. The other operational scenarios were evaluated in the 2022 Lake Analysis Update and assume no discharge to Shay Pond. The TP Offset scenarios assume a TP Offset Program is implemented.
- b) Expressed as annual average concentrations
- c) Chlorophyll-a shown as growing season average concentrations

Overall, the predicted long-term average concentrations of TDS, TIN, TN, TP, and chlorophyll-a were lower with the proposed Lake discharge at various rates as compared to the predicted baseline condition, except for TIN under the 2,210 AFY + TP Offset. It is unclear why the model predicted increased TIN under this scenario while all other scenarios showed significantly reduced TIN values relative to the modeled baseline; however, the modeled difference in TIN between the Baseline and 2,210 AFY + TP Offset scenarios is approximately 4%, which is within the range of model variance and is considered statistically insignificant. Therefore, this analysis concludes that projected long-term average concentration of TIN is similar to the modeled baseline condition.

Focusing on chlorophyll-a as the key response target, baseline conditions were predicted to yield a growing season average chlorophyll-a concentration that slightly exceeded (by 0.1 µg/L) the Nutrient TMDL target value of 14 µg/L, while Alternative 3 matched the target value, and increased Lake discharges that varied seasonally (**Figure 8**) yielded values below the modeled baseline condition and the Nutrient TMDL target values. The assumption of a TP Offset Program yielded further reductions in chlorophyll-a. The increased Lake discharge volumes with reduced summer flows and no net TP loading were predicted to yield growing season average chlorophyll-a concentrations as low as 9.5 to 10.2 µg/L, significantly below predicted baseline and TMDL concentrations.

Cumulative distribution functions (CDFs) were prepared to evaluate the inter-annual differences in water quality, as differences are expected to persist. **Figure 9** shows the CDFs for TP, TN, and chlorophyll-a, which show that increased Lake discharges are predicted to lower the annual average TP and TN concentrations and growing season average chlorophyll-a concentrations. However, wide ranges in predicted concentrations remained in place. **Table 10** shows the predicted frequency of exceedance of the Nutrient TMDL targets or potential targets. Overall, the growing season chlorophyll-a average TMDL target (14 µg/L) was predicted to be exceeded about 53% of the time under baseline conditions and exceeded about 41% and 31% of the time at a 2,210 AFY Lake discharge rate with and without TP offset, respectively.

Antidegradation Analysis for Proposed Discharges to Stanfield Marsh/Big Bear Lake and Shay Pond

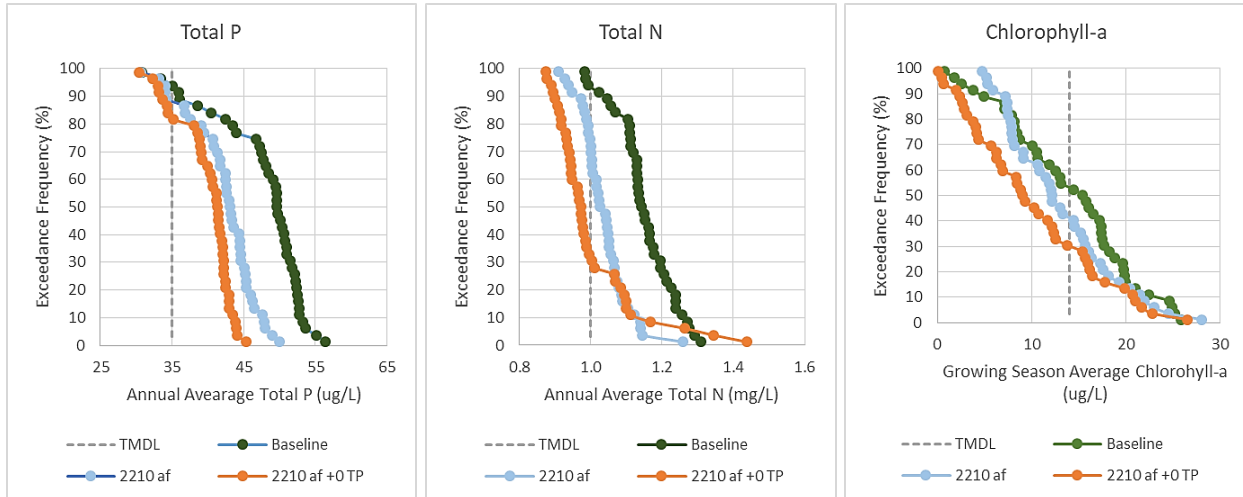

Figure 9. CDFs for Predicted Annual TP and TN Concentrations and Growing Season Average Chlorophyll-a Concentrations for Baseline Condition and at 2,210 AFY Lake Discharge with and without TP Offset

Table 10. Predicted Frequency of Exceeding TMDL Target Under Baseline Conditions and Different Lake Discharge Rates and TP Offset Scenarios (Annual Average or Growing Season Average Basis)

Operational Scenario (All at 50 th %tile hydrologic condition)	TP (µg/L)	TN ^(a) (mg/L)	Chlorophyll-a ^(b) (µg/L)
WQO/(TMDL target)	0.15 (35.0)		(14.0)
Baseline (No Project)	94%	91%	53%
Alternative 3 (1920 AFY)	87%	72%	51%
2,210 AFY (99% recovery)	87%	72%	41%
2,009 AFY (90% recovery)	91%	80%	40%
2,210 AFY + TP Offset	82%	30%	31%
2,009 AFY + TP Offset	90%	55%	22%

Notes:

- a) Possible target of 1 mg/L, per the Regional Water Board input.
- b) Growing season is the period from May 1 through October 31 of each year.

In general, the Lake Analysis demonstrates that the Lake discharge will likely contribute to more frequent attainment of the Nutrient TMDL numeric targets and associated water quality standards, especially when combined with the offset program and actions taken by the TMDL responsible parties to attain the Nutrient TMDL requirements. Additionally, the Lake discharge will increase Lake levels, which will contribute to protection of other beneficial uses and reduce the amount of time critical hydrologic conditions occur in the Lake. A more robust analysis of this Lake discharge on the Nutrient TMDL is provided in Attachment B of the ROWD package.

5.3.1.2 Lake Discharge Impacts on Lake Level, Volume, and Area

The Lake Analysis simulations for the 2009-2019 evaluation period demonstrated that the Replenish Big Bear Program Lake discharge would result in significant increases in predicted lake levels, volumes, and surface areas relative to baseline conditions. Long-term (2009 to 2050) simulations of the proposed Lake discharge under three different hydrologic scenarios indicate that the discharge would be especially beneficial under an “extended drought” scenario where the discharge is predicted to increase the median lake level by more than 10 ft and the median lake area by nearly 600 acres, which in turn would improve recreational access and provide additional Lake habitat as compared to modeled baseline (no project) conditions. The increased lake level and area benefits provided by the Lake discharge would be more modest under the “prolonged above average rainfall” scenario because higher natural inflows would result in higher lake levels. **Table 11** summarizes the projected impacts on Lake level, area, and volume under three hydrologic conditions modeled in the 2021 Lake Analysis.

Table 11. Predicted Lake Level, Area, and Volume under Three Hydrologic Scenarios

Lake Physical Parameter (median values shown)	Scenario	Hydrologic Scenario		
		Extended Drought (5 th Percentile)	Median Hydrologic Condition (50 th Percentile)	Prolonged Above Average Rainfall (95 th Percentile)
Lake Level (ft) (Lake max 6,743 ft)	Baseline	6,722	6,733	6,736
	+Project	6,732 (+10.5)	6,738 (+7.2)	6,740 (+5.2)
Volume (AF)	Baseline	23,400	47,536	54,724
	+Project	45,750 (+22,340)	59,664 (+12,128)	65,204 (+10,480)
Area (acres)	Baseline	1,720	2,328	2,474
	+Project	2,290 (+572)	2,568 (+240)	2,669 (+195)

Notes: Data taken from Table 24 of Lake Analysis report. Assumed a discharge rate of 1,920 AFY. Additional benefit is expected with a higher discharge rate.

5.3.2 Boron Mass Balance

The projected boron effluent quality of the proposed Lake discharge is anticipated to exceed the Lake ambient water quality (0.054 mg/L – based on one sample collected in December 2021) but remain well below the most stringent criterion of 0.75 mg/L for the protection of sensitive crops. Therefore, the Lake’s boron assimilative capacity, defined as the difference between the criterion and the ambient water quality, is 0.694 mg/L (i.e., 0.75 mg/L – 0.054 mg/L).

Due to the limited amount of water quality data available, a simple spreadsheet model was completed to evaluate the contribution of the Lake discharge to boron concentrations in the Lake over time. The calculations are shown in **Appendix F**. The only available data for boron contributions to the Lake from natural inflows is based on boron samples collected in 1972 from several creeks. These data indicated that boron in natural inflows could range between 0.02 and 0.26 mg/L. These results were not used in this analysis due to its high variability, age of the samples, small sample size, and changes in watershed characteristics since the samples were collected.

This analysis did not establish a baseline condition based on ambient water quality; rather, it was assumed that the Lake and natural inflows had a boron concentration of 0 mg/L and the analysis determined the incremental increase of boron in the Lake as result of the Lake discharge.

The 1977-2020 annual inflow and outflow were obtained from the Big Bear Watermaster annual reports and a 43-year simulation was performed based on a repeat of this historic hydrology. The following equations were used to perform the mass balance:

$$\text{Lake Storage} = \text{Initial Lake Storage} + \text{Lake Inflows} - \text{Lake Outflows}$$

$$\text{Lake Inflows} = \text{Lake inflows from precipitation and/or snowmelt}$$

$$\text{Lake Outflows} = \text{Spills} + \text{Releases} + \text{Leakage} + \text{Withdrawals} + \text{Evaporation}$$

$$\text{Boron Mass} = \text{Boron in Lake} + \text{Boron from Lake Inflow} \\ + \text{Boron from Discharge} - \text{Boron from Lake Outflows}$$

$$\text{Boron Concentration in Lake (mg/L)} \\ = \frac{\text{Boron mass in Lake at end of simulation year}}{\text{Lake volume at end of simulation year}}$$

Figure 10 shows the projected boron Lake concentrations over the simulation period. The Lake discharge is anticipated to increase boron concentrations over the 44-year simulation, boron is predicted to increase by about 0.065 mg/L. This is less than the 10% assimilative capacity.

The projected incremental increase in boron concentration in the Lake as a result of the project is 0.065 mg/L at the end of the 44-year simulation. The simulation results represent an incremental increase above the current ambient quality, which was 0.054 mg/L based on one sample collected in December 2021. Based on this sample, the estimated total boron concentration in the Lake with the proposed discharge would be below 0.12 mg/L, which is considered safe for agricultural crops like citrus trees that show sensitivity to boron starting at concentrations between 0.5 – 0.75 mg/L (USDA, 1990). The projected boron concentration will remain low compared to the most stringent criterion of 0.75 mg/L which exists in the Basin Plan for the protection of water used to irrigate sensitive crops.

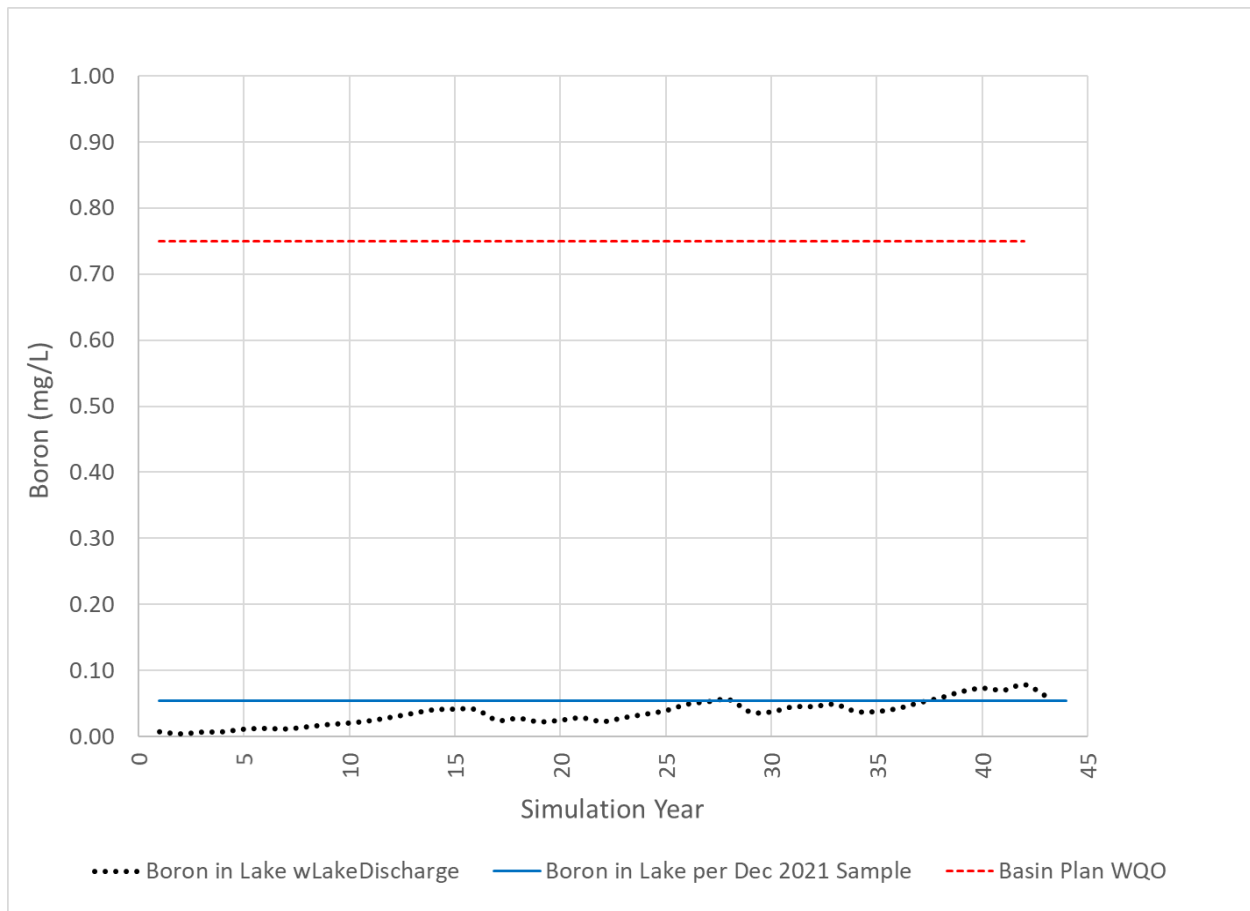

Figure 10. Projected Boron Concentrations with Proposed Lake Discharge

5.4 Summary of Water Quality Impacts

Overall, the Replenish Big Bear Program Lake discharge under most modeled discharge scenarios is anticipated to improve water quality for TDS, TIN, TP, TN, and chlorophyll-a as compared to baseline conditions, and result in similar water quality for total inorganic nitrogen (TIN) as compared to the modeled baseline. In addition, the proposed discharge is projected to contain concentrations of constituents of interest that are similar to or lower than existing ambient water quality and most stringent WQO or criteria for all constituents evaluated except for TIN and boron. For boron, concentrations in the Lake are anticipated to increase compared to baseline conditions but remain well below the most stringent WQO of 0.75 mg/L and the estimated increase is below the U.S. EPA significance threshold of a 10% reduction in available assimilative capacity.

Overall, the Lake Analysis and the 2022 Lake Model Update show that the implementation of the Lake discharge will help improve water quality of the Lake, especially during extended drought and typical (median) conditions. In addition, the proposed Lake discharge will increase lake levels, surface area, and volumes which will help to protect the beneficial uses designated for the Lake.

6 ASSESSMENT OF WATER QUALITY IMPACTS TO SHAY POND

This section describes the proposed Shay Pond discharge component of the Replenish Big Bear Program and presents an antidegradation analysis of the proposed discharge. Currently, it is unknown if Shay Pond and Shay Creek are considered Waters of the U.S. (WOTUS), as the federal regulations that define a WOTUS are currently under review. Regional Water Board input is required to determine the appropriate permitting approach for the proposed discharge to Shay Pond. The necessary background information to assist the Regional Water Board with this determination is provided in this section.

6.1 Shay Pond Environmental Setting and Project Description

As part of the Replenish Big Bear Program, up to 80 AFY of disinfected, advanced treated effluent is proposed for discharge to Shay Pond. The proposed Shay Pond discharge is intended to replace potable water that is currently discharged to the pond to support the Unarmored Threespine Stickleback (Stickleback) fish, a federal and State listed endangered species.

Shay Pond has a surface area of approximately 10 acres and is located about 1.2 miles southeast of the BBARWA WWTP (**Figure 1**). According to the Bear Valley Basin Groundwater Sustainability Plan (GSP), “Shay Pond is a natural surface water body at the southern base of an unnamed ridge that separates it from Baldwin Lake (. The nature of this pond is unknown, but it may be fed, in part, from spring flow, surface runoff, and periodically, groundwater intersecting the land surface. Although the pond may have historically been fed from surface water runoff in the ephemeral, upstream segment of Shay Creek, urban development has altered the course of this stream, and it no longer flows into the pond. Surface water exits Shay Pond via the downstream segment of Shay Creek, which flows northwards toward Baldwin Lake and intermittently provides water to Baldwin Lake lake.” “Surface water sources to Baldwin Lake are primarily in the form of ephemeral streams with relatively low flow volumes. The only stream where surface water flow periodically has been measured is Shay Creek at its outlet from Shay Pond.” “Surface water runoff does not reach Baldwin Lake during most years but percolates into the groundwater system. However, during prolonged precipitation, surface water does flow into Baldwin Lake. All surface water that enters Baldwin Lake is lost to evaporation. The high clay content of the playa sediments prevents vertical migration, and the topographical configuration of the lake prevents outflow from Baldwin Lake” (TH&Co, 2022). **Figure 11** shows how

Antidegradation Analysis for Proposed Discharges to Stanfield Marsh/Big Bear Lake and Shay Pond

Baldwin Lake, an ephemeral lake, is connected to Shay Pond via Shay Creek. This figure also shows the population of Stickleback fish in the vicinity of Shay Pond.

The population of Stickleback is unique in that it occurs at a high elevation, about 6,700 ft above mean sea level, while all other Stickleback populations inhabit streams below 3,000 ft. In 1985 and 1986, catastrophic mortality of Stickleback in the Valley occurred due to insufficient amounts of water. By the summer of 1990, it was thought that the Stickleback remained in only Shay Pond.

There is a long history of study and group effort regarding the Stickleback in the Shay Creek area. The main stakeholders include the United States Fish and Wildlife Service (USFWS), CDFW, the San Bernardino National Forest (SBNF), BBCCSD, BBLDWP, and BBARWA. Additionally, the Shay Creek Working Group, which includes representatives from the USFWS, CDFW, SBNF, BBCCSD, BBLDWP, and BBARWA, was formed during the process of preparing the USFWS' 2002 Biological Opinion (2002 BO) for the area (Evans, 2002).

The requirements of the 2002 BO state that BBCCSD will provide water to Shay Pond to maintain a minimum 20-gallon-per-minute outflow from Shay Pond. The objective is to maintain a minimum pond water level that will support suitable habitat conditions for the fish. BBCCSD currently meets this requirement by discharging potable water into Shay Pond, but the 2002 BO also states that, should a suitable alternative supply of water be found to be appropriate for the stickleback in the future, BBCCSD may use an 'in-lieu' water supply, which could include the use of tertiary-treated water. The potable water discharged to Shay Pond represents approximately 5% of BBCCSD's customer water demand and could be reserved for potable use instead of discharging to Shay Pond.

The discharge rate needed to maintain the required outflow, accounting for evaporation and infiltration, has varied from year to year. However, based on the average volume of discharges measured between 2012 and 2020, BBCCSD discharges approximately 50 AFY of potable water to Shay Pond on average. At times, the required discharge has been up to 80 AFY; this maximum volume is used as the basis for the project design and analysis to be conservative. **Figure 12** shows an aerial view of Shay Pond and the proposed discharge location.

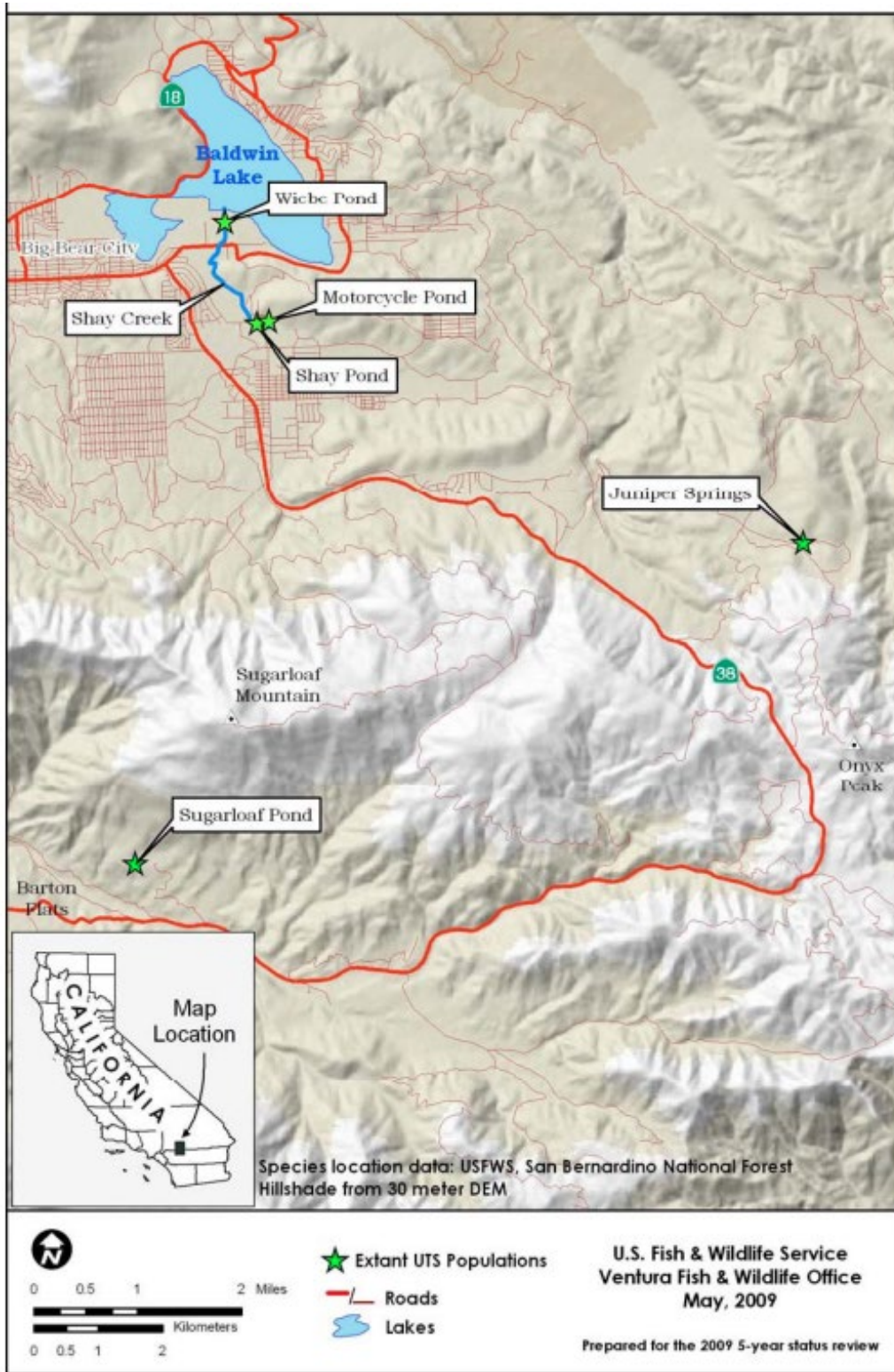

(Source: USFWS, 2009)

Figure 11. Population of Stickleback Fish in the Vicinity of Shay Pond



Figure 12. Shay Pond Aerial View

6.2 Applicable Water Quality Standards

Per the Basin Plan, the protection of beneficial uses designated for Shay Creek and Baldwin Lake is primarily provided by narrative water quality objectives. **Table 12** shows the designated beneficial uses of Shay Creek and Baldwin Lake, which are receiving waters for flows from Shay Pond. Baldwin Lake has intermittent beneficial uses as the lake is ephemeral. The water quality objectives used to protect the beneficial uses designated for Shay Creek and, therefore, Shay Pond are presented in **Table 13**, along with ambient Shay Pond water quality, the quality of the current potable water supply to the pond, and the proposed effluent quality of the proposed discharge.

Table 12. Beneficial Uses of Shay Pond Receiving Waters

Beneficial Uses	Shay Creek	Baldwin Lake
COLD – Cold Freshwater Habitat	✓	I
GWR – Groundwater Recharge	✓	
MUN – Municipal and Domestic Supply	✓	I

Beneficial Uses	Shay Creek	Baldwin Lake
RARE – Rare, Threatened, or Endangered Species	✓	I
REC1 – Water Contact Recreation	✓	I
REC2 – Non-Contact Water Recreation	✓	I
SPWN – Spawning, Reproduction, and/or Early Development	✓	
WARM – Warm Freshwater Habitat		I
WILD – Wildlife Habitat	✓	I
Notes: ✓ - Existing or Potential Beneficial Use; I - Intermittent Beneficial Use		

6.3 Assessment of Water Quality Impacts

The water quality data available for Shay Pond are limited, so a detailed water quality assessment using Shay Pond data could not be completed. For this analysis, the existing water quality of potable water supplies near Shay Pond were compared to the projected effluent quality of the proposed Shay Pond discharge to determine if there is a potential for degradation of Shay Pond water quality as a result of the proposed discharge. The water quality collected in Shay Pond as part of the ROWD application is provided as reference. A similar approach as outlined in **Section 5.2.1** was used to determine if the proposed discharge to Shay Pond could contribute to ambient water quality degradation. **Table 13** presents the results of this analysis.

Water quality data for the specific well that discharges to Shay Pond is not available so the data used for this analysis was obtained by compiling and averaging the water quality data from seven drinking water wells near Shay Pond, which is expected to be representative of the quality of groundwater currently discharged to Shay Pond. BBCCSD collected these data in 2020. The projected effluent quality was estimated as described in **Section 5.1** and presented in **Table 5**. As part of the ROWD process, BBCCSD sampled Shay Pond for 156 constituents, of which only 19 analytes were detected.

Overall, the projected effluent quality of the proposed discharge to Shay Pond is better than the current potable water supply for chloride, hardness, sodium, sulfate, TDS, TN, aluminum, and specific conductance. The projected effluent quality of the proposed discharge is expected to be of similar quality as existing potable water supplies for ammonia, fluoride, MBAS, cadmium, copper, and lead. However, additional data may be needed to confirm these findings. Boron may be the only constituent that could be above the existing potable water supply quality. However, the average boron concentration in the disinfected, advanced treated effluent proposed for discharge to the pond is well below the 0.75 mg/L Basin Plan objective for boron for the protection of sensitive agricultural crops, which is not a use of Shay Pond water.

Additional coordination with the CDFW will be conducted to ensure the Stickleback fish are protected.

Table 13. Comparison of Most Stringent Water Quality Objective or Criterion to Current BBCCSD Potable Water Supply Quality and Projected Effluent Quality of Proposed Discharge

Constituent	Units	Reference for Most Stringent WQO or Criterion	Average Quality of Potable Groundwater Supply ^(a)	Shay Pond Ambient Quality ^(b)	Projected Effluent Quality of Proposed Discharge	Comparison of Projected Effluent Quality to Most Stringent WQO (See Table Notes)
Ammonia as N	mg/L	1.4 [©]	NS	0.24	0.05	1
Boron	mg/L	0.75	<0.1	0.059	0.11	2
Chloride	mg/L	500	9	7.6	0.60	1
Fluoride	mg/L	0.9	2.1	1.2	<0.026	1
Hardness, Total (as CaCO ₃)	mg/L	100	209	180	3.2	1
MBAS	mg/L	0.05	<0.1	<0.1	0.0014	1
Sulfate	mg/L	500	39	23	0.20	1
Total Dissolved Solids	mg/L	1000	291	320	50	1
Total Nitrogen	mg/L-N	10	NS	1.2	0.60	1
Cadmium	µg/L	1.5 ^(d)	<1	<1	<0.11	1
Copper	µg/L	16.6 ^(d)	<50	<50	0.07	1
Lead	µg/L	3.5 ^(d)	<5	<5	0.01	1
Aluminum	µg/L	200	<50	120	1.3	1
Specific Conductance	µmhos/cm	700/1000	496	450	18	1

Notes: NS – Not sampled/no data

- a) The average groundwater potable water supply was estimated from 7 domestic wells that were tested and are near Shay Pond. NDs were excluded from the average. Constituents with all ND are reported as "<RL." The MDL was not provided.
- b) For Shay Pond, only one sample is available. The results are reported. ND are reported as "<MDL."
- c) The total ammonia was estimated using the equation presented in Table 4-4 of the Basin Plan. The field temperature on November 17, 2021, was 56 °F (13.3°C) and pH was 7.7.
- d) The cadmium, copper, and lead SSO were estimated using a total hardness value of 180 mg/L, based on the sample collected as Shay Pond.

Antidegradation Analysis for Proposed Discharges to Stanfield Marsh/Big Bear Lake and Shay Pond

Constituent	Units	Reference for Most Stringent WQO or Criterion	Average Quality of Potable Groundwater Supply ^(a)	Shay Pond Ambient Quality ^(b)	Projected Effluent Quality of Proposed Discharge	Comparison of Projected Effluent Quality to Most Stringent WQO (See Table Notes)
-------------	-------	-----------------------------------------------	--------------------------------------------------------------	------------------------------------------	--------------------------------------------------	----------------------------------------------------------------------------------

Blue – Projected effluent quality is below the ambient and most stringent WQO or criterion

Red – Projected effluent quality is above the ambient or most stringent WQO or criterion

- 1) Projected effluent quality is below the ambient and most stringent WQO or criterion. No degradation anticipated.
- 2) Projected effluent quality is above the ambient, but below the most stringent WQO or criterion. Further analysis needed to determine impacts on water quality.

7 EVALUATION OF CONSISTENCY WITH ANTIDEGRADATION POLICY

The guidelines set by the State Water Board for the antidegradation analysis (APU 90-004) provide direction on evaluating the proposed discharges to Stanfield Marsh/ Lake and Shay Pond by focusing on whether and the degree that water quality is lowered, and by considering whether or not the assumed water quality discharge is consistent with the maximum benefit to the people of the State. In developing the antidegradation analysis, the beneficial uses and relevant water quality objectives and commonly used criteria for the Lake and Shay Pond were considered.

7.1 Benefits of Proposed Project

The proposed discharges of disinfected, advanced treated wastewater to Stanfield Marsh and Shay Pond maximize the use of a local sustainable water supply within the Valley region through the surface water discharge of highly treated wastewater produced by BBARWA to directly benefit the community and environment and support the following beneficial uses in the Lake, Stanfield Marsh, and Shay Pond: AGR (Lake only), COLD, GWR (Lake and Pond), MUN, RARE, REC1, REC2, SPWN (Lake and Pond), WARM (Lake and Pond), and WILD (see **Table 1** and **Table 12** for additional details). The proposed Lake and Shay Pond discharges as part of the Replenish Big Bear Program are anticipated to provide the following benefits:

- A new local drought proof water supply will reduce the Valley's vulnerability to drought, both for the community and the environment.
- A new constant source of water supply to Stanfield Marsh that will provide more stable aquatic and riparian habitat for diverse species and more opportunities for the community to realize the educational and recreational benefits of Stanfield Marsh. The marsh has been mostly dry since 2015 but with the project, the 145-acre marsh area will be at least 50% wetted even during dry years.
- Increased Lake levels will provide more wetted shoreline to enhance aquatic and riparian habitat in the Lake.
- Increased lake levels provide increased opportunities and flexibility for BBMWD to conduct lake management activities, such as weed harvesting to control aquatic macrophytes. Such activities are anticipated to enhance the contact and non-contact recreation in the Lake.

- Increased Lake levels will improve Lake access for boats and personal watercraft and allow for continued use of Lake water for snowmaking in the winter, both of which will act to maintain and enhance tourism, the single largest driver of the Big Bear economy.
 - The number of boat permits sold is directly impacted by Lake levels, and it is anticipated that increased levels will result in the sale of additional boat permits and increased rates of associated recreation and tourism, all of which stimulate the local and regional economies.
 - Visitors in the winter are directly tied to weather conditions and the Resorts' ability to facilitate snow activities by extracting Lake water to make snow when Lake levels are high enough.
 - The Transient Occupancy Tax (TOT) is the second largest revenue source for the City of Big Bear Lake, making up approximately 27% of the general-purpose revenues. Revenue from tourists fluctuate depending on the timing and amount of precipitation the region receives and Lake levels.
 - A strengthened tourist economy is expected to provide additional job growth and stability. Project implementation is estimated to create 3 new permanent positions at the WWTP, 242 temporary construction jobs and 480 indirect jobs.
- Higher Lake levels will result in reduced demand on SWP water, which is used in lieu of Lake water to meet Mutual's water needs when Lake levels are low.
- Increased inflow to the Lake will result in the Lake being full more frequently and will provide BBMWD additional flexibility in optimizing Lake releases to provide new downstream benefits to the Santa Ana Watershed, including increased flows in Bear Creek and the Santa Ana River to support habitat and additional downstream capture of surface water for groundwater recharge.
- The Lake discharge provides opportunities to use of a portion of the Lake water for subsequent uses that provide additional potable water supply and recreational benefits through direct and in-lieu groundwater recharge and enhanced snowmaking capabilities (these uses are anticipated to be permitted separately).

- A new source of high-quality water will be discharged to Shay Pond to support 10 acres of habitat for the federally listed Stickleback. The new source of water enables the potable water currently used for this purpose to be stored in the groundwater basin to enhance water supply sustainability.

7.2 Socioeconomic Considerations

As a result of the project benefits described in **Section 7.1**, the proposed project will act to support important economic and social development in the Valley.

The project proponents are voluntarily committing the resources necessary to construct and operate an advanced wastewater treatment facility to discharge disinfected, RO treated effluent of the quality that could be permitted to be discharged to the Lake as a means to achieve the multiple project benefits described above. The commitment of resources by the project proponents to construct, operate, and maintain the proposed treatment facility will result in increased wastewater fees paid by residents and businesses in the Valley. The capital cost of the proposed facilities required for the Lake and Shay Pond discharges is estimated at \$56 M (in 2021 dollars) and the annual operations and maintenance (O&M) costs are estimated at \$2.4 M (in 2021 dollars). These capital and O&M expenditures are estimated to result in an increase in wastewater fees of approximately \$150-\$200 per connection per year.

Increased wastewater fees that would be paid by residents and businesses in the Valley with implementation of the proposed project are not without local and regional economic impacts. The estimated increase in wastewater fees would need to be paid by households and businesses out of their existing household incomes or operations budgets, respectively. In effect, additional wastewater fees would be paid out of funds that are currently available for other purposes. With respect to households, future increased wastewater fees would result in less disposable personal income available to a household for the purchase of other goods and services. Similarly, an increase in annual utility costs for a business could result in one or more of the following: increased costs for the goods and/or services it provides and/or decreased reinvestment in the business. With respect to individual households, increases in utility costs have a disproportionate effect on households at the lowest socioeconomic levels.

While the estimated increase in annual wastewater fees with implementation of the proposed project is not estimated to produce substantial and widespread economic impacts in the Valley, a requirement to add additional wastewater treatment beyond the advanced level of treatment included in the proposed project could trigger substantial and widespread socioeconomic impacts. Furthermore, the project proponents believe that the cost of any additional required wastewater treatment would not produce improvements in receiving

water quality that are proportionate with the cost of additional treatment. The benefits of maintaining existing water quality and mass emissions in the Lake and Shay Pond for the constituents analyzed in this antidegradation analysis are not commensurate with the costs of additional wastewater treatment, beyond what is included in the proposed project, should such treatment be recommended. The small decrease in water quality with respect to the constituents considered in this analysis is unlikely to affect beneficial uses of the Lake, Shay Pond, and downstream receiving waters.

7.3 Consistency with Antidegradation Policies

The proposed project, the discharge of disinfected, advanced treated BBARWA effluent to (1) Stanfield Marsh/Big Bear Lake at a discharge rate up to 2,210 AFY and (2) Shay Pond at a discharge rate up to 80 AFY, is determined to comprise best practicable treatment and control and is consistent with federal and State antidegradation policies for the following reasons:

- The proposed discharge to both Stanfield Marsh/Big Bear Lake and Shay Pond will not adversely affect existing or probable beneficial uses of either receiving water or downstream receiving waters, nor will the discharges cause water quality to not meet applicable water quality objectives.
- Overall, the proposed discharge is estimated to improve water quality in the Lake for TDS, TN, TP, and chlorophyll-a, maintain similar water quality for TIN, and have a very minor impact on boron. Future boron concentrations in the Lake are estimated to increase very slightly (i.e., less than 10% of the available assimilative capacity) due to the proposed BBARWA discharge but are estimated to remain well below the 0.75 mg/L Basin Plan objective for boron (see **Table 7** and **Section 5.3.2**). The Lake Analysis shows that projected ambient Lake concentrations of TIN and chlorophyll-a with the proposed discharge will exist below their relevant water quality objective (TIN) or TMDL target (chlorophyll-a). The Lake Analysis also shows that ambient Lake concentration of TDS and TP with the proposed discharge are estimated to exceed the 175 mg/L TDS objective and the 35 µg/L TP TMDL target, respectively. However, the modeled baseline (no project) condition is projected to result in Lake concentrations for TDS, TP, TIN, and chlorophyll-a that exceed those concentrations more often than all modeled BBARWA discharge scenarios. Modeled results for the proposed BBARWA discharge, when combined with a TP Offset Program (see Attachment B of the ROWD package), show the greatest improvements to future, ambient Lake concentrations as compared to the modeled baseline (no project) condition.

- Overall, the proposed BBARWA discharge is estimated to have a very minor impact on Shay Pond water quality and Shay Creek water quality downstream of the pond. The proposed project is estimated to potentially cause a very minor increase in boron concentrations in the pond and downstream in Shay Creek, but concentrations are estimated to remain well below the 0.75 mg/L Basin Plan objective for boron. The disinfected, advanced treated effluent proposed for discharge to the pond is anticipated to lower the concentrations of those constituents listed in **Table 13** as compared to existing ambient concentrations that are largely influenced by the groundwater currently discharged by BBCCSD to the pond to maintain water levels for the endangered Stickleback fish.
- Based on the above, the request to permit a new discharge to both Stanfield Marsh/Big Bear Lake and Shay Pond is consistent with federal and state antidegradation policies in that the minor lowering of water quality for boron in Big Bear Lake (see **Table 7**) and Shay Pond (see **Table 13**) is necessary to accommodate important economic or social development⁵, will not unreasonably affect beneficial uses, will not cause further exceedances of applicable water quality objectives, and is consistent with the maximum benefit to the people of the State.
- Based on the above, the request to permit new discharges to Stanfield Marsh/Big Bear Lake and Shay Pond are consistent with the Porter-Cologne Act in that the resulting water quality will constitute the highest water quality that is reasonable, considering all demands placed on the waters, economic and social considerations, and other public interest factors.

The proposed discharge of disinfected, advanced treated BBARWA effluent to Stanfield Marsh/Big Bear Lake and Shay Pond also fully supports California's *Recycled Water Policy* (SWRCB, 2013) in that it would result in an increased use of recycled water from municipal wastewater sources, would incrementally reduce reliance on the vagaries of annual precipitation, and would assist in the sustainable management of surface and groundwater resources.

⁵ Maintain and improve recreation and tourism in the Big Bear Lake region which in turn stimulates the local and regional economies.

8 REFERENCES

Anderson, M.A., 2021. *Big Bear Lake Analysis: Replenish Big Bear*. Final Report.

Anderson, M.A. 2022. *Replenish Big Bear: Modeling of Higher Flows and with Zero TP Load*. Final Report.

Attwater, W. R., 1987. Federal Antidegradation Policy. Memorandum to Regional Board Executive Officers. October 7, 1987.

California State Water Resources Control Board (SWRCB), 2021. *2018 Integrated Report for Clean Water Act Section 303(d) List / 305(b) Final Staff Report*. Released January 14, 2021.

California State Water Resources Control Board (SWRCB), 2013. *Policy for Water Quality Control for Recycled Water (Recycled Water Policy)*. Revised January 22, 2013.

Evans, Karen A., 2002. *Biological Opinion on Forest Service Special Use Permits for Wastewater Collection and Conveyance Facilities in the Baldwin Lake Watershed, San Bernardino National Forest, San Bernardino County, California*. Carlsbad : United States Department of the Interior Fish and Wildlife Service, 2002. 1-6-01-F-1980.

Santa Ana Regional Water Quality Control Board. *Water Quality Control Plan (Basin Plan) for the Santa Ana River Basin*. Updated June 2019.

Thomas Harder & Co., 2022. *Bear Valley Basin Groundwater Sustainability Plan*. January 2022.

U.S. Fish and Wildlife Service (USFWS). *Unarmored Threespine Stickleback (Gasterosteus aculeatus williamsoni) 5-Year Review: Summary and Evaluation*. Ventura Fish and Wildlife Office, 2009.

United States Department of Agriculture (USDA), 1990. *Boron Tolerance Limits for Agricultural Crops*. Last Updated July, 30, 2019. <https://www.ars.usda.gov/pacific-west-area/riverside-ca/agricultural-water-efficiency-and-salinity-research-unit/docs/databases/boron-tolerance-of-crops/>

United States Environmental Protection Agency (U.S. EPA), 1987. *Guidance on implementing the antidegradation provisions of 40 C.F.R. § 131.12*. June 3.

U.S. EPA, 2005. *Memorandum to Water Management Division Directors, Regions 1-10, regarding Tier 2 Antidegradation Reviews and Significance Thresholds*. Washington, D.C.: King, Ephram S., Director, Office of Science and Technology. August 10, 2005.

Water Systems Consulting Inc. (WSC), 2020. *Draft Replenish Big Bear Treatment Process Alternatives Technical Memorandum*. February 2020.

WSC & Larry Walker Associates (LWA), 2022. *Approach to Address Big Bear Lake Nutrient Total Maximum Daily Load in the NPDES Permit for Big Bear Area Regional Wastewater Agency*. February 2022.

Big Bear Area Regional Wastewater Agency

Replenish Big Bear

Antidegradation Analysis for Proposed Discharges to Stanfield Marsh/Big Bear Lake and Shay Pond

APPENDIX A: WDR R7 R7-2021-0023

CALIFORNIA REGIONAL WATER QUALITY CONTROL BOARD COLORADO RIVER BASIN REGION

Office
73-720 Fred Waring Dr. #100
Palm Desert, CA 92260

waterboards.ca.gov/coloradoriver/

ORDER R7-2021-0023



Order Information

Discharger: Big Bear Regional Wastewater Agency
Facility: Export of Recycled Water to Lucerne Valley
Address: 122 Palomino Drive,
Big Bear City, California 92314
County: San Bernardino County
WDID: 7A360100011
GeoTracker ID: WDR100027897

I, PAULA RASMUSSEN, Executive Officer, hereby certify that the following is a full, true, and correct copy of the order adopted by the California Regional Water Quality Control Board, Colorado River Basin Region, on May 11, 2021.

Original signed by

PAULA RASMUSSEN
Executive Officer

Contents

Findings..... 1

 Wastewater Treatment Facility and Discharge 2

 Hydrogeologic Conditions..... 4

 Basin Plan, Beneficial Uses, and Regulatory Considerations..... 6

 Antidegradation Analysis 8

 Stormwater 11

 CEQA and Public Participation 12

IT IS HEREBY ORDERED 12

 A. Effluent Limitations..... 12

 B. Receiving Water Limitations..... 13

 C. Discharge Prohibitions 13

 D. Discharge Specifications..... 14

 E. Standard Provisions 17

Attachment A—Vicinity Map..... 1

Attachment B—Process Flow Diagram 1

Attachment C—Lucerne Valley Facility Layout 1

Monitoring and Reporting Program R7-2021-0023 1

 A. Sampling and Analysis General Requirements..... 1

 B. Effluent Monitoring 3

 C. Overflow Pond Monitoring..... 5

 D. Domestic Water Supply Monitoring 5

 E. Groundwater Monitoring..... 6

 F. Reporting Requirements 6

CALIFORNIA REGIONAL WATER QUALITY CONTROL BOARD
COLORADO RIVER BASIN REGION

ORDER R7-2021-0023

WASTE DISCHARGE REQUIREMENTS
FOR
BIG BEAR AREA REGIONAL WASTEWATER AGENCY, OWNER/OPERATOR
EXPORT OF RECYCLED WATER TO LUCERNE VALLEY
LUCERNE VALLEY-SAN BERNARDINO COUNTY

The California Regional Water Quality Control Board, Colorado River Basin Region (Regional Water Board) hereby makes the following Findings:

1. Big Bear Area Regional Wastewater Agency (BBARWA or Discharger), P.O. Box 517, Big Bear City, California 92314, owns 480 acres in the Lucerne Valley, of which 340 acres are irrigated with recycled water from the Discharger's Wastewater Treatment Plant (WWTP). There are an additional 140 acres available for irrigation, also in the Lucerne Valley. BBARWA's WWTP provides sewerage service to the City of Big Bear Lake, Big Bear City Community Services District, and County Service Area 53-B. The WWTP is located at 122 Palomino Drive, Big Bear City, California 92314, and has a design treatment capacity of 4.89 million gallons-per-day (MGD) and a hydraulic capacity of 9.2 MGD. The Facility is assigned California Integrated Water Quality System (CIWQS) number CW-208930, Waste Discharge Identification (WDID) number 7A360100011, and GeoTracker Global Identification number WDR100027897.
2. The WWTP is located outside the boundary of the Colorado River Basin Water Board (Regional Water Board) and is regulated by the California Regional Water Quality Control Board, Santa Ana Region (Santa Ana Water Board) under Waste Discharge Requirements (WDRs) Order R8-2005-0044.
3. The WWTP has the following types of treatment: preliminary treatment, secondary treatment, and sludge drying and treatment. Secondary treated wastewater from the WWTP is disposed of through three possible discharge points that are designated in Order R8-2005-0044 as Point 001, Point 002, and Point 003. The discharges from the WWTP at Points 002 and 003 are regulated by the Santa Ana Regional Water Quality Control Board. The majority of the treated wastewater is discharged through Discharge Point 001 into the Lucerne Valley to irrigate fodder, fiber, and seed crops. A minimal volume of treated wastewater is discharged through Points 002 and 003 for recycling and reuse at various sites for irrigation, dust control at construction sites, and wildlife habitat restoration in the Baldwin Lake.
4. This Order regulates the discharge from the WWTP at Point 001. Infrastructure associated with this discharge includes a concrete-lined reservoir and two overflow

ponds that are used to dispose of treated recycled wastewater by percolation and evaporation in the Lucerne Valley (Lucerne Valley Facility or Facility).

5. The Lucerne Valley Facility is located near the intersection of State Highway 247 (Old Woman Springs Road) and Camp Rock Road in the Lucerne Valley of San Bernardino County in Section 14, T4N, R1E, SBB&M, and Assessor's Parcel Number (APN) 0449-082-040000, 34.438554°N Latitude, -116.851225°W Longitude. The Facility's location is shown in **Attachment A-** Vicinity Map, made part of this Order by reference.
6. The Lucerne Valley Facility was most recently regulated by WDRs in Order R7-2016-0026, which was adopted by the Regional Water Board on June 30, 2016.
7. On October 28, 2020, the Discharger submitted an application and Report of Waste Discharge (ROWD) to the Regional Water Board, applying for updated WDRs for the Facility.
8. This Order updates the WDRs to comply with current laws and regulations applicable to the discharge. Accordingly, this Order supersedes WDRs in Order R7-2016-0026 upon the effective date of this Order, except for enforcement purposes.

Wastewater Treatment Facility and Discharge

9. Wastewater that is discharged at the Lucerne Valley Facility goes through preliminary and secondary treatment at the WWTP before it is sent via gravity to the concrete reservoir at the Lucerne Valley Facility. The WWTP components that are used for treatment are described below and the Process Flow Diagram for the WWTP is shown in **Attachment B**—Process Flow Diagram.
 - a. **Preliminary Treatment.** Untreated wastewater flows to the preliminary treatment system, which consists of bar screens, aerated grit chamber with grit washer, and a flow bypass channel. This treatment stage removes screenings, rag material, and grit.
 - b. **Secondary Treatment.** Effluent flows by gravity from the preliminary treatment system to three parallel oxidation ditches for secondary (biological) treatment and timed processes for nutrient (nitrogen) removal. The number of ditches in operation depends on the seasonal fluctuations of the influent flow. The effluent from the oxidation ditches flows into a system of three secondary clarifiers for removal of floatable and settleable solids/materials. The secondary treated effluent flows to two cement-lined balancing chambers and then flows to equalization storage ponds at the WWTP until pumped for offsite irrigation disposal.
 - c. **Offsite Irrigation/Disposal.** Undisinfected secondary treated wastewater is pumped from the WWTP's main pump building (5.2 MGD) or auxiliary

pump building (9.2 MGD) approximately 16.5 miles to an offsite 2.26-million-gallon, concrete-lined reservoir (undisinfected secondary recycled water reservoir). This reservoir is located one mile south of the irrigation site. Wastewater from the reservoir flows by gravity through an outfall line connected to the irrigation system. In the event of an overflow at the concrete-lined reservoir, the wastewater flows by gravity to earthen overflow ponds located adjacent to the irrigation site.

10. Approximately 2.12 MGD of undisinfected secondary recycled water (as defined in California Code of Regulations, title 22, section 60301.900) is discharged to the Lucerne Valley Facility for irrigation of fodder and fiber crops. Undisinfected secondary wastewater was approved by the California Department of Public Health (succeeded by the State Water Resources Control Board's [State Water Board] Division of Drinking Water) for irrigation use at this site. Approximately 340 acres are currently irrigated at the Lucerne Valley Facility, with an additional 140 acres available for irrigation at the site. The effluent discharge limit of 4.8 MGD in this Order is based on the capacity of the irrigated crops to take up nitrogen. The Lucerne Valley Facility site layout is shown in **Attachment C**, made part of this Order by reference.
11. The State Water Board's Division of Drinking Water has established statewide reclamation criteria in California Code of Regulations, title 22, section 60301 et seq. for the use of recycled water and developed guidelines for specific uses. Section 60304(d)(4) allows the use of undisinfected, secondary recycled water for the surface irrigation of fodder and fiber crops and pasture for animals not producing milk for human consumption. BBARWA's Title 22 Engineering Report was initially approved on November 3, 1980 and was last updated November 4, 1998, to allow for the use of tertiary treated wastewater in the Big Bear Area.
12. The grazing of sheep on the irrigation site has been allowed under certain conditions, as outlined in a letter from Regional Water Board staff dated November 15, 1994, and in Discharge Specification D.18 of this Order.
13. No sewage sludge is discharged at the recycled water reuse site.
14. BBARWA's Self-Monitoring Reports (SMRs) from January 2016 through December 2020 characterize the WWTP effluent as follows:

Table 1. Effluent Characterization

Constituent	Units	Average	Maximum	Minimum
Flow	MGD	2.12	8.39	0.441

Constituent	Units	Average	Maximum	Minimum
20° C BOD ₅ ¹	mg/L ²	8	36	ND ³
TSS ⁴	mg/L	8	44	1
pH	s.u. ⁵	7.61	8.46	6.85
Total Dissolved Solids (TDS)	mg/L	441	520	350
Total Inorganic Nitrogen (TIN) ⁶	mg/L	3.9	22.3	0.4
Total Nitrogen (TN)	mg/L	4.9	12	1.8
Nitrate as N	mg/L	1.7	7.7	0.04
Chloride	mg/L	56	87	34
Sulfate	mg/L	40	48	29
Fluoride	mg/L	0.43	0.61	0.24
Boron	mg/L	0.20	0.32	<0.1

Hydrogeologic Conditions

15. Lucerne Valley Groundwater Basin underlies Lucerne and North Lucerne Valleys and is bounded on the south by the San Bernardino Mountains and on the west by the Granite Mountains and the Helendale fault. The Ord Mountains bound the basin on the north. The Camp Rock fault and Kane Wash Area Groundwater Basin bound this basin on the east and the Fry Mountains bound this basin on the southeast. Parts of the eastern and southeastern boundaries are surface drainage

¹ 5-day biochemical oxygen demand at 20 degrees Celsius.

² Milligrams per Liter

³ Not Detected at the laboratory's Reporting Limit.

⁴ Total Suspended Solids

⁵ Standard pH units

⁶ Total Inorganic Nitrogen is the sum of nitrate, nitrite, and total ammonia.

divides. Surface water drains toward Lucerne (dry) Lake in the western portion of the basin, which has an altitude of 2,850 feet above sea level (Schaefer 1979⁷).

16. The principal water-bearing deposits are Quaternary age alluvium, and dune sand. The deposits are unconsolidated or semi-consolidated and the alluvium is composed of gravel, sand, silt, clay, and occasional boulders. Where saturated, the alluvium yields water freely to wells. The average specific yield for these deposits is 11 percent. Irrigation wells in the basin yield as much as 1,000 gallons per minute (Schaefer 1979).
17. BBARWA has three groundwater monitoring wells (MW-1-upgradient; MW-2-downgradient; and MW-3-downgradient). Groundwater levels in monitoring wells have increased since the wells were constructed in 1991. BBARWA has reported that the depth to groundwater at the Lucerne Valley Facility is within the range of 125 to 175 feet below ground surface (bgs) and groundwater flow direction is generally to the northwest, towards Lucerne Dry Lake.
18. Groundwater monitoring data collected from monitoring wells MW-1, MW-2, and MW-3 during the period from 2017 through 2020 show the following average characteristics:

Table 2. Groundwater Monitoring Data

Constituent	Units	MW-1	MW-2	MW-3
Depth to Groundwater	ft	170	125.2	138.1
TDS	mg/L	435.5	655.2	583
TN	mg/L	9.54	15.1	15.9
Nitrate as N	mg/L	8.97	14.5	15.4
Sulfate	mg/L	62.1	138.4	179.7
Chloride	mg/L	70.3	123.4	109.1
Fluoride	mg/L	0.19	0.14	0.24
Boron	mg/L	0.12	0.11	0.09
VOCs	ug/L	ND	ND	ND

⁷ Schaefer, D.H. 1979. *Ground-Water Conditions and Potential for Artificial Recharge in Lucerne Valley, San Bernardino County, California*. U.S. Geological Survey Water Resources Investigations 78-118. 37 p.

19. Annual precipitation in the Lucerne Valley region averages about 14 inches.
20. Typically, November through April are considered wet weather, while May through October are considered dry weather months.
21. There are several domestic wells in the vicinity of the irrigation recycled use area and the evaporation/percolation ponds.
22. Water supply to the Big Bear area communities is from numerous groundwater production wells located in Big Bear Valley. TDS in the water supply averages about 280 mg/L based on data reported in the BBARWA's SMRs from 2017 through 2020.
23. BBARWA conducted a geotechnical study referenced as *Geotechnical Study, Irrigation Site, Lucerne Valley Area, San Bernardino County, California for Big Bear Area Regional Wastewater Agency, July 29, 1977*, as an initial investigation of the site for use for irrigation. The report shows that the site is underlain by soils consisting of fine to coarse, clean to silty sands containing various amounts of gravel from 5 to 24 feet below ground surface. Beneath this, to a depth of 60 to 100 feet below ground surface, the soil consists of fine to medium silty sands containing varying amounts of gravel and is locally cemented with calcium carbonate accumulated during deposition of the sediments. Bedrock underlies the older alluvium at a depth of 400 to 600 feet.

Basin Plan, Beneficial Uses, and Regulatory Considerations

24. The Water Quality Control Plan for the Colorado River Basin Region (Basin Plan), adopted on November 17, 1993 and most recently amended on January 8, 2019, designates beneficial uses, establishes water quality objectives, and contains implementation programs and policies to achieve those objectives for all waters addressed through the plan. Pursuant to Water Code section 13263, subdivision (a), WDRs must implement the Basin Plan and take into consideration the beneficial uses to be protected, the water quality objectives reasonably required for that purpose, other waste discharges, the need to prevent nuisance, and the provisions of Water Code section 13241.
25. The Facility is located within the Lucerne Hydrologic Unit, and the Basin Plan designates the following beneficial uses for groundwater:
 - a. Municipal Supply (MUN),
 - b. Industrial Supply (IND), and
 - c. Agricultural Supply (AGR).

26. This Order establishes WDRs pursuant to division 7, chapter 4, article 4 of the Water Code for discharges that are not subject to regulation under Clean Water Act section 402 (33 U.S.C. § 1342).
27. These WDRs implement numeric and narrative water quality objectives for groundwater and surface waters established by the Basin Plan and other applicable state and federal laws and policies. The numeric objectives for groundwater designated for municipal and domestic supply include the maximum contaminant levels (MCLs) specified in California Code of Regulations, title 22, section 64421 et seq. Groundwater for use as domestic or municipal water supply (MUN) must not contain taste- or odor-producing substances in concentrations that adversely affect beneficial uses as a result of human activity.
28. It is the policy of the State of California that every human being has the right to safe, clean, affordable, and accessible water adequate for human consumption, cooking, and sanitary purposes. This Order promotes that policy by requiring discharges to meet MCLs designed to protect human health and ensure that water is safe for domestic use.
29. The discharge authorized by this Order, except for discharges of residual sludge and solid waste, are exempt from the solid waste requirements of California Code of Regulations, title 27, section 20005 et seq. This exemption is based on section 20090, subdivisions (a) and (b) of title 27 of the California Code of Regulations, which provides that discharges of domestic sewage or wastewater to land, including but not limited to evaporation ponds, percolation ponds, or subsurface leach fields are not subject to the requirements of title 27 if the following exemption conditions are met:
 - a. The applicable regional water board has issued WDRs, reclamation requirements, or waived such issuance;
 - b. The discharge is in compliance with the applicable water quality control plan; and
 - c. The wastewater does not need to be managed according to chapter 11, division 4.5, title 22 of the California Code of Regulations as a “hazardous waste.”
30. The discharge of waste authorized by these WDRs satisfies the conditions to be exempted from the requirements of title 27 of the California Code of Regulations, because (1) the discharge is regulated by these WDRs; (2) these WDRs will ensure the discharge complies with the Basin Plan; and (3) the discharge will not be of a “hazardous waste.”
31. Consistent with Water Code section 13241, the Regional Water Board, in establishing the requirements contained herein, considered factors including, but not limited to, the following:

- a. Past, present, and probable future beneficial uses of water;
 - b. Environmental characteristics of the hydrographic unit under consideration, including the quality of water available thereto;
 - c. Water quality conditions that could reasonably be achieved through the coordinated control of all factors which affect water quality in the area;
 - d. Economic considerations;
 - e. The need for developing housing within the region(s); and
 - f. The need to develop and use recycled water.
32. Water Code section 13267 authorizes the Regional Water Board to require technical and monitoring reports. The monitoring and reporting requirements in Monitoring and Reporting Program (MRP) R7-2021-0023 are necessary to demonstrate compliance with this Order. The State Water Resources Control Board's (State Water Board's) electronic database, GeoTracker Information Systems, facilitates the submittal and review of monitoring and reporting documents. The burden, including costs, of the MRP bears a reasonable relationship to the need for that information and the benefits to be obtained from that information.
33. Pursuant to Water Code section 13263, subdivision (g), the discharge of waste is a privilege, not a right, and adoption of this Order does not create a vested right to continue the discharge.

Antidegradation Analysis

34. State Water Board Resolution 68-16, entitled *Statement of Policy with Respect to Maintaining High Quality Waters in California* (Resolution 68-16), generally prohibits the Regional Water Board from authorizing discharges that will result in the degradation of high quality waters, unless it is demonstrated that any change in water quality will (a) be consistent with maximum benefit to the people of the state, (b) not unreasonably affect beneficial uses, and (c) not result in water quality less than that prescribed in state and regional policies (e.g., the violation of one or more water quality objectives). The discharger must also employ best practicable treatment or control (BPTC) to minimize the degradation of high quality waters. High quality waters are surface waters or areas of groundwater that have a baseline water quality better than required by water quality control plans and policies.
35. Some degradation of groundwater from the discharge to the irrigation recycled use area and the infiltration basins is consistent with Resolution 68-16, provided that the degradation:

- a. Is confined to a reasonable area;
 - b. Is minimized by means of full implementation, regular maintenance, and optimal operation of BPTC measures by the Discharger;
 - c. Is limited to waste constituents typically encountered in domestic wastewater;
 - d. Does not unreasonably affect any beneficial uses of groundwater prescribed in the Basin Plan, and will not result in the violation of any water quality objective; and
 - e. Is consistent with the maximum benefit to the people of the state.
36. Recycled water used for irrigation at the Lucerne Valley Facility is treated to secondary standards and has undergone substantial removal of soluble organic matter, solids, and nitrogen treatment. Constituents in the wastewater effluent that have the potential to degrade groundwater include nitrogen, chloride, sulfate, TDS, and total coliform. Each of these constituents is discussed below:
- a. **Nitrogen.** The Primary Maximum Contaminant Level (MCL) found in California Code of Regulations, title 22, section 64431 for nitrate plus nitrite as nitrogen is 10 mg/L. To account for the fate of transport for the various components of total nitrogen, as a conservative value, it is assumed that all nitrogen present converts to nitrate/nitrite. BBARWA's SMRs report an average of 3.9 mg/L for Total Inorganic Nitrogen and 4.9 mg/L for Total Nitrogen between January 2016 and December 2020. BBARWA conducted a study of the groundwater in the vicinity of the recycled water irrigation use site in September 2016 which included an analysis of potential sources of nitrate in the groundwater other than BBARWA recycled water. Some of the sources included onsite farming practices, irrigation and fertilization in excess of plant demands, and potential upgradient sources, such as discharges from individual onsite septic systems. The study found that nitrate concentrations have been increasing in the upgradient groundwater monitoring well but have been decreasing in the downgradient monitoring wells. To verify no degradation due to nitrogen is occurring, this Order requires quarterly total nitrogen and nitrate as nitrogen monitoring in the groundwater monitoring wells. This Order also provides an average monthly effluent limit for total nitrogen of 10 mg/L.
 - b. **Chloride and Sulfate.** The "recommended" Secondary MCLs in California Code of Regulations, title 22, section 64449 for chloride and sulfate are both 250 mg/L. Concentrations of chloride and sulfate are included in TDS measurements. BBARWA's SMRs report an average of 56 and 40 mg/L for chloride and sulfate, respectively, between January 2016 and December 2020. Additionally, BBARWA's SMRs, for the same time period, report a maximum of 87 and 48 mg/L for chloride and sulfate, respectively.

BBARWA occasionally experience increases in chloride due to the use of salt and brine on local roadways prior to snowstorm events. To evaluate the incremental degradation due to chloride and sulfate, this Order requires quarterly chloride and sulfate monitoring in the groundwater monitoring wells. This Order also provides an average monthly effluent limit of 60 mg/L and a daily maximum effluent limit of 80 mg/L for both chloride and sulfate.

- c. **TDS.** The Secondary MCL specified in California Code of Regulations, title 22, section 64449 for TDS ranges between the “recommended” consumer acceptance level of 500 mg/L and the “upper” consumer acceptance level of 1,000 mg/L, if it is neither reasonable nor feasible to provide more suitable waters. The typical incremental addition of dissolved salts from domestic water usage in wastewater treatment plants ranges from 150 to 380 mg/L. Domestic water supply to the Big Bear area communities showed an average concentration of about 280 mg/L based on data reported in the BBARWA’s SMRs from 2017 through 2020. From 2016 to December 2020, treated wastewater discharged had an average TDS concentration of approximately 440 mg/L. Thus, the average TDS increase over the domestic water supply in the discharge was about 160 mg/L. Based on the study that the Discharger conducted in September 2016, which analyzed the impacts of groundwater by the discharge, the results would help establish an appropriate effluent limitation for TDS. The study states that the average TDS concentration in the Lucerne Valley Groundwater Basin is closer to 500 mg/L in the vicinity of the discharge location, whereas the Basin as a whole has an average of approximately 1,100 mg/L. Downgradient TDS concentrations in groundwater were found to be equal to or above concentrations of water delivered to the discharge location and the basin-wide average TDS concentration is above that of the delivered water. Therefore, the delivered water is not expected to degrade the existing groundwater quality or limit existing downgradient beneficial uses. To verify there is no degradation due to TDS is occurring, this Order includes quarterly TDS monitoring in the groundwater monitoring wells. This Order also provides an effluent limit for TDS of 550 mg/L over a 12-month period.
- d. **Total Coliform.** Secondary treatment reduces fecal coliform densities by 90 to 99%; the remaining organisms in effluent are still 10^5 to 10^6 most probable number (MPN)/100 mL (U.S. Environmental Protection Agency, *Design Manual: Municipal Wastewater Disinfection*, EPA/625/1-86/021, October 1986.) Other sources of *E. Coli* may include residential septic systems and runoff from animal waste, which are both present in the areas surrounding the groundwater monitoring wells. Given the depth to groundwater, which is approximately 125 to 175 feet, it is not likely that pathogen-indicator bacteria will reach groundwater in excess of that prescribed in California Code of Regulations, title 22, section 64426.1, due to significant attenuation and removal in the soils in the vadose zone. To evaluate the potential degradation to groundwater due to pathogens, this

Order includes quarterly *E. coli* monitoring in the groundwater monitoring wells and monthly *E. coli* monitoring in the effluent.

37. The discharge of wastewater from the Facility, as permitted herein, reflects BPTC. The Facility incorporates:
- a. Technology for secondary treated domestic wastewater;
 - b. Structural controls to dispose of waste constituents in a designated area;
 - c. A network of groundwater monitoring wells;
 - d. An operation and maintenance manual;
 - e. An Irrigation Management Plan;
 - f. Staffing to ensure proper operation and maintenance; and
 - g. A standby emergency power generator of sufficient size to operate the treatment plant and ancillary equipment during periods of loss of commercial power.
38. Degradation of groundwater by some of the typical waste constituents associated with discharges from a facility treating domestic wastewater, after effective source control, treatment, and control measures are implemented, is consistent with the maximum benefit to the people of the state. The technology, energy, water recycling, and waste management advantages of regional utility service far exceed any benefits derived from reliance on numerous, concentrated individual wastewater systems, and the impact on water quality will be substantially less. These factors, when taken in conjunction with the associated increase in waste constituents, are consistent with the maximum benefit to the people of the state. Accordingly, the discharge, as authorized, is consistent with the antidegradation provisions of Resolution 68-16 and applicable water quality objectives.

Stormwater

39. Federal regulations for stormwater discharges were promulgated by the U.S. Environmental Protection Agency on November 16, 1990 (40 C.F.R. parts 122, 123, and 124) to implement the Clean Water Act's stormwater program set forth in Clean Water Act section 402, subdivision (p) (33 U.S.C. § 1342(p)). In relevant part, the regulations require specific categories of facilities that discharge stormwater associated with industrial activity to "waters of the United States" to obtain National Pollutant Discharge Elimination System (NPDES) permits and to require control of such pollutant discharges using Best Available Technology Economically Achievable (BAT) and Best Conventional Pollutant Control Technology (BCT) to prevent and reduce pollutants and any more stringent controls necessary to meet water quality standards.

40. The State Water Board adopted Order 2014-0057-DWQ (NPDES No. CAS000001), *General Permit for Storm Water Discharges Associated with Industrial Activities* (Industrial General Permit) on July 1, 2015. Facilities used in the storage, treatment, recycling, and reclamation of municipal or domestic sewage with a design flow of one million gallons per day or more, or that are required to have an approved pretreatment program under 40 Code of Federal Regulations part 403, are required to enroll under the Industrial General Permit, unless there is no discharge of industrial stormwater to waters of the United States.

CEQA and Public Participation

41. Pursuant to California Code of Regulations, title 14, section 15301, the issuance of these WDRs, which govern the operation of an existing facility involving negligible or no expansion of use beyond that previously existing, is exempt from the provisions of the California Environmental Quality Act (CEQA), Public Resources Code section 21000 et seq.
42. The Regional Water Board has notified the Discharger and all known interested agencies and persons of its intent to issue WDRs for this discharge, and has provided them with an opportunity for a public meeting and to submit comments.
43. The Regional Water Board, in a public meeting, heard and considered all comments pertaining to this discharge.

IT IS HEREBY ORDERED that Order R7-2016-0026 is rescinded upon the effective date of this Order, except for enforcement purposes, and, in order to meet the provisions contained in division 7 of the Water Code, and regulations adopted thereunder, the Discharger shall comply with the following:

A. Effluent Limitations

1. Effluent used for irrigation in the recycled use area or discharged into the overflow evaporation/percolation ponds for disposal shall not exceed the following effluent limits:

Table 3. Effluent Limitations

Constituent	Units	Monthly Average	Weekly Average	Daily Maximum
20°C BOD ₅	mg/L	30	45	--
Total Suspended Solids	mg/L	30	45	--
Chloride	mg/L	60	--	80

Constituent	Units	Monthly Average	Weekly Average	Daily Maximum
Sulfate	mg/L	60	--	80
Boron	mg/L	--	--	0.75
Total Nitrogen	mg/L	10	--	--

2. The 30-day average daily dry weather discharge for irrigation shall not exceed 4.8 MGD.
3. The hydrogen ion concentration (pH) in the effluent discharge for irrigation shall be maintained within the limits of 6.0 to 9.0 standard units.
4. The TDS concentration of the effluent shall not exceed a 12-month average effluent limit of 550 mg/L. The reported concentration shall be determined by the arithmetic mean of the last twelve months of monitoring.
5. The overflow evaporation/percolation ponds shall be maintained so that they continuously operate in aerobic conditions. The dissolved oxygen content in the upper zone (one foot) of the infiltration basins shall be equal to or greater than 1.0 mg/L.

B. Receiving Water Limitations

1. The discharge of wastewater from the Facility shall not cause groundwater to: exceed applicable water quality objectives; acquire taste, odor, toxicity, or color that create nuisance conditions; impair beneficial uses; or contain constituents in excess of California Maximum Contaminant Levels (MCLs), as set forth in title 22 of the California Code of Regulations (including, but not limited to, section 64426.1 for bacteriological constituents; section 64431 for inorganic chemicals; section 64444 for organic chemicals; and section 64678 for lead and copper).

C. Discharge Prohibitions

1. Discharge of waste classified as “hazardous,” as defined in California Code of Regulations, title 27, section 20164, or “designated,” as defined in Water Code section 13173 and California Code of Regulations, title 27, section 20164, is prohibited.
2. The discharge of treated wastewater at a location other than the designated disposal areas or as recycled water used for irrigation at approved use areas, is prohibited.

3. The discharge of wastewater and/or recycled water to surface waters or surface drainage courses is prohibited.
4. The Discharger shall not accept waste in excess of the design treatment capacity of the Facility's disposal system.
5. Surfacing or ponding of wastewater outside of the designated disposal locations is prohibited.
6. Application of treated wastewater for irrigation in excess of agronomic rates is prohibited.
7. Bypass or overflow of untreated or partially-treated waste is prohibited, except as permitted in Standard Provision E.13.
8. The discharge of wastewater to a location or in a manner different from that described in this Order is prohibited.
9. The discharge of wastewater to land not owned or controlled by the Discharger, or not authorized for such use, is prohibited.
10. The storage, treatment, or disposal of wastes from the Facility shall not cause contamination, pollution, or nuisance as defined in Water Code section 13050, subdivisions (k), (l), and (m).

D. Discharge Specifications

1. The Discharger shall maintain sufficient freeboard in the overflow evaporation/percolation ponds to accommodate seasonal precipitation and to contain a 100-year storm event, but in no case no less than two (2) feet of freeboard (measured vertically). Freeboard shall be utilized for wake and waves of fluid motion and emergency or natural disaster purposes only.
2. All treatment, storage, and disposal areas shall be designed, constructed, operated and maintained to prevent inundation or washout due to floods with a 100-year return frequency.
3. Evaporation/percolation ponds shall have sufficient capacity to accommodate allowable wastewater flow, design seasonal precipitation, ancillary inflow, and infiltration. Design seasonal precipitation shall be based on total annual precipitation using a return period of 100 years, distributed monthly in accordance with historical rainfall patterns.
4. The evaporation/percolation ponds shall be managed to prevent breeding of mosquitoes. In particular:

- a. An erosion control program should ensure that small coves and irregularities are not created around the perimeter of the water surface.
 - b. Weeds shall be minimized through control of water depth, harvesting, or herbicides.
 - c. Dead algae, vegetation, and debris shall not accumulate on the water surface.
5. Public contact with wastewater shall be precluded through such means as fences, signs, or other acceptable alternatives.
6. Objectionable odors originating at the Facility shall not be perceivable beyond the property boundary.
7. The evaporation/percolation ponds shall be maintained and operated so as to maximize infiltration and minimize the increase of salinity in the groundwater.
8. Onsite wastes, including windblown spray from recycled water application, shall be strictly confined to the lands specifically designated for the disposal operation, and onsite irrigation practices shall be managed so there is no runoff of effluent from irrigated areas.
9. No irrigation with, or impoundment of, undisinfected secondary recycled water shall take place within 150 feet of any domestic water supply well.
10. No spray irrigation of any recycled water shall take place within 100 feet of a residence or a place where public exposure could be similar to that of a park, playground or schoolyard.
11. Except as allowed under California Code of Regulations, title 17, section 7604, no physical connection shall be made or allowed to exist between any recycled water system and any separate system conveying potable water.
12. Undisinfected secondary recycled water, as defined in California Code of Regulations, title 22, section 60301.900, may only be used for irrigation in the following applications:
 - a. Orchards where the recycled water does not come into contact with the edible portion of the crop;
 - b. Vineyards where the recycled water does not come into contact with the edible portion of the crop;

- c. Non-food bearing trees (Christmas tree farms are included in this category provided no irrigation with recycled water occurs for a period of 14 days prior to harvesting or allowing access by the general public);
 - d. Fodder and fiber crops and pasture for animal not producing milk for human consumption;
 - e. Seed crops not eaten by humans;
 - f. Food crops that must undergo commercial pathogen-destroying processing before being consumed by humans; and
 - g. Ornamental nursery stock and sod farms provided no irrigation with recycled water occurs for a period of 14 days prior to harvesting, retail sale, or allowing access by the general public.
13. No recycled water used for irrigation, or soil that has been irrigated with recycled water, shall come into contact with edible portions of food crops eaten raw by humans.
14. The delivery or use of recycled water shall conform with the reclamation criteria contained in California Code of Regulations, title 22 or amendments thereto, for the irrigation of food crops, irrigation of fodder, fiber, and seed crops, landscape irrigation, supply of recreational impoundments, and groundwater recharge.
15. Prior to delivering recycled water to any new user, the Discharger shall submit to the Regional Water Board a report discussing any new distribution system being constructed by the Discharger to provide service to the new user.
16. Recycled water shall not be delivered to any new user who has not first received a discharge permit from the Regional Water Board and approval from the State Water Board's Division of Drinking Water.
17. Treated or untreated sludge or similar solid waste materials shall be disposed of at locations approved by the Regional Water Board's Executive Officer.
18. Grazing of sheep on the irrigation site is allowed only under the following conditions, unless otherwise approved by the Regional Water Board 's Executive Officer:
 - a. Grazing will only be conducted in October or November after the last cutting of hay has been baled;

- b. Grazing animals will not be allowed into a portion of the site until 10 days after it was last irrigated;
- c. Temporary fences will be erected to contain the grazing animals in an area of 40 acres or less;
- d. Only ewes that are about to lamb or ewes with newly born will be grazed;
- e. No animals will be sold for slaughter within 90 days after grazing; and
- f. No milk produced by sheep that have grazed at the irrigation site shall be used for human consumption.

E. Standard Provisions

1. **Noncompliance.** The Discharger shall comply with all of the terms, requirements, and conditions of this Order and MRP R7-2021-0023. Noncompliance is a violation of the Porter-Cologne Water Quality Control Act (Water Code, § 13000 et seq.) and grounds for: (1) an enforcement action; (2) termination, revocation and reissuance, or modification of these waste discharge requirements; or (3) denial of an Order renewal application.
2. **Enforcement.** The Regional Water Board reserves the right to take any enforcement action authorized by law. Accordingly, failure to timely comply with any provisions of this Order may subject the Discharger to enforcement action. Such actions include, but are not limited to, the assessment of administrative civil liability pursuant to Water Code sections 13323, 13268, and 13350, a Time Schedule Order (TSO) issued pursuant to Water Code section 13308, or referral to the California Attorney General for recovery of judicial civil liability.
3. **Proper Operation and Maintenance.** The Discharger shall at all times properly operate and maintain all systems and components of collection, treatment, and control installed or used by the Discharger to achieve compliance with this Order. Proper operation and maintenance includes, but is not limited to, effective performance, adequate process controls, and appropriate quality assurance procedures. This provision requires the operation of backup or auxiliary facilities/systems when necessary to achieve compliance with this Order. All systems in service or reserved shall be inspected and maintained on a regular basis. Records of inspections and maintenance shall be retained and made available to the Regional Water Board on request.
4. **Reporting of Noncompliance.** The Discharger shall report any noncompliance that may endanger human health or the environment,

including spills in excess of one thousand (1,000) gallons occurring within the Facility or collection system. Information shall be provided orally to the Regional Water Board office and the Office of Emergency Services within twenty-four (24) hours of when the Discharger becomes aware of the incident. If noncompliance occurs outside of business hours, the Discharger shall leave a message on the Regional Water Board's office voicemail. A written report shall also be provided within five business days of the time the Discharger becomes aware of the incident. The written report shall contain a description of the noncompliance and its cause, the period of noncompliance, the anticipated time to achieve full compliance, and the steps taken or planned to reduce, eliminate, and prevent recurrence of the noncompliance. A final certified report must be submitted through the online GeoTracker system, within 15 calendar days of the conclusion of spill response and remediation. Additional information may be added to the certified report, in the form of an attachment, at any time. All other forms of noncompliance shall be reported with the Discharger's next scheduled Self-Monitoring Report (SMR), or earlier if requested by the Regional Water Board's Executive Officer or if required by an applicable standard for sludge use and disposal.

5. **Duty to Mitigate.** The Discharger shall take all reasonable steps to minimize or prevent any discharge in violation of this Order that has a reasonable likelihood of adversely affecting human health or the environment.
6. **Material Changes.** Prior to any modifications which would result in any material change in the quality or quantity of wastewater treated or discharged, or any material change in the location of discharge, the Discharger shall report all pertinent information in writing to the Regional Water Board, and if required by the Regional Water Board, obtain revised requirements before any modifications are implemented.
7. **Design Capacity Report.** The Discharger shall provide a report to the Regional Water Board when it determines that the Facility's average dry-weather flow rate for any month exceeds 80 percent of the design capacity. The report should indicate what steps, if any, the Discharger intends to take to provide for the expected wastewater treatment capacity necessary when the plant reaches design capacity.
8. **Operational Personnel.** The Facility shall be supervised and operated by persons possessing certification of appropriate grade pursuant to section 3680, chapter 26, division 3, title 23 of the California Code of Regulations.
9. **Familiarity with Order.** The Discharger shall ensure that all site-operating personnel are familiar with the content of this Order and maintain a copy of this Order at the site.

10. **Inspection and Entry.** The Discharger shall allow the Regional Water Board, or an authorized representative, upon presentation of credentials and other documents as may be required by law, to:
 - a. Enter the premises regulated by this Order, or the place where records are kept under the conditions of this Order;
 - b. Have access to and copy, at reasonable times, records kept under the conditions of this Order;
 - c. Inspect at reasonable times any facilities, equipment (including monitoring and control equipment), practices, or operations regulated or required under this Order; and
 - d. Sample or monitor at reasonable times, for the purpose of assuring compliance with this Order or as otherwise authorized by the Water Code, any substances or parameters at this location.

11. **Records Retention.** The Discharger shall retain copies of all reports required by this Order and the associated MRP. Records shall be maintained for a minimum of five years from the date of the sample, measurement, report, or application. Records may be maintained electronically. This period may be extended during the course of any unresolved litigation regarding this discharge or when requested by the Regional Water Board's Executive Officer.

12. **Change in Ownership.** This Order is not transferable to any person without written approval by the Regional Water Board's Executive Officer. Prior to any change in ownership of this operation, the Discharger shall notify the Regional Water Board's Executive Officer in writing at least 30 days in advance. The notice must include a written transfer agreement between the existing owner and the new owner. At a minimum, the transfer agreement must contain a specific date for transfer of responsibility for compliance with this Order and an acknowledgment that the new owner or operator is liable for compliance with this Order from the date of transfer. The Regional Water Board may require modification or revocation and reissuance of this Order to change the name of the Discharger and incorporate other requirements as may be necessary under the Water Code.

13. **Bypass.** Bypass (i.e., the intentional diversion of waste streams from any portion of the treatment facilities, except diversions designed to meet variable effluent limits) is prohibited. The Regional Water Board may take enforcement action against the Discharger for bypass unless:
 - a. Bypass was unavoidable to prevent loss of life, personal injury, or severe property damage. Severe property damage means substantial physical damage to property, damage to the treatment

facilities that causes them to be inoperable, or substantial and permanent loss of natural resources reasonably expected to occur in the absence of a bypass. Severe property damage does not mean economic loss caused by delays in fee collection; and

- b. There were no feasible alternatives to bypass, such as the use of auxiliary treatment facilities or retention of untreated waste. This condition is not satisfied if adequate back-up equipment was not installed to prevent bypass occurring during equipment downtime, or preventative maintenance; or
- c. Bypass is (1) required for essential maintenance to ensure efficient operation; (2) neither effluent nor receiving water limitations are exceeded and (3) the Discharger notifies the Regional Water Board ten (10) days in advance.

In the event of an unanticipated bypass, the Discharger shall immediately report the incident to the Regional Water Board. During non-business hours, the Discharger shall leave a message on the Regional Water Board's office voicemail. A written report shall be provided within five (5) business days after the Discharger is aware of the incident. The written report shall include a description of the bypass, any noncompliance, the cause, period of noncompliance, anticipated time to achieve full compliance, and steps taken or planned to reduce, eliminate, and prevent recurrence of the noncompliance.

14. **Backup Generators.** Standby, power generating facilities shall be available to operate the Facility during a commercial power failure.
15. **Format of Technical Reports.** The Discharger shall furnish, under penalty of perjury, technical monitoring program reports, and such reports shall be submitted in accordance with California Code of Regulations, title 23, division 3, chapter 30, as raw data uploads electronically over the Internet into the State Water Board's [GeoTracker database](#). Documents that are normally mailed by the Discharger to the Regional Water Board, such as regulatory documents, narrative monitoring reports or materials, and correspondence, shall also be uploaded into GeoTracker in the appropriate Microsoft Office software application format, such as Word or Excel files, or as a Portable Document Format (PDF) file. Large documents must be split into appropriately-labelled, manageable file sizes and uploaded into GeoTracker.
16. **Qualified Professionals.** In accordance with Business and Professions Code sections 6735, 7835, and 7835.1, engineering and geologic evaluations and judgments shall be performed by or under the direction of California registered professionals (i.e., civil engineer, engineering geologist, geologist, etc.) competent and proficient in the fields pertinent to

the required activities. All technical reports required under this Order that contain work plans, describe the conduct of investigations and studies, or contain technical conclusions and recommendations concerning engineering and geology shall be prepared by or under the direction of appropriately-qualified professional(s), even if not explicitly stated. Each technical report submitted by the Discharger shall contain a statement of qualifications of the responsible licensed professional(s) as well as the professional's signature and/or stamp of the seal. Additionally, all field activities are to be conducted under the direct supervision of one or more of these professionals.

17. **Certification Under Penalty of Perjury.** All technical reports required in conjunction with this Order shall include a statement by the Discharger, or an authorized representative of the Discharger, certifying under penalty of perjury under the laws of the State of California, that the reports were prepared under his or her supervision in accordance with a system designed to ensure that qualified personnel properly gathered and evaluated the information submitted, and that based on his or her inquiry of the person or persons who manage the system, the information submitted is, to the best of his or her knowledge and belief, true, complete, and accurate.
18. **Violation of Law.** This Order does not authorize violation of any federal, state, or local laws or regulations.
19. **Property Rights.** This Order does not convey property rights of any sort, or exclusive privileges, nor does it authorize injury to private property or invasion of personal rights.
20. **Modification, Revocation, Termination.** This Order may be modified, revoked and reissued, or terminated for cause. The filing of a request by the Discharger for an Order modification, rescission, or reissuance, or the Discharger's notification of planned changes or anticipated noncompliance, does not stay any Order condition. Causes for modification include, but are not limited to, the violation of any term or condition contained in this Order, a material change in the character, location, or volume of discharge, a change in land application plans or sludge use/disposal practices, or the adoption of new regulations by the State Water Board, Regional Water Board (including revisions to the Basin Plan), or federal government.
21. **Severability.** The provisions of this Order are severable. If any provision of this Order is found invalid, the remainder of these requirements shall not be affected.

Any person aggrieved by this Regional Water Board action may petition the State Water Board for review in accordance with Water Code section 13320 and California Code of Regulations, title 23, section 2050 et seq. The State Water

Board must receive the petition by 5:00 p.m. on the 30th day after the date of this Order; if the 30th day falls on a Saturday, Sunday, or state holiday, the petition must be received by the State Water Board by 5:00 p.m. on the next business day. Copies of the statutes and regulations applicable to filing petitions are available on the State Water Board's website and can be provided upon request.

Order Attachments

Attachment A—Vicinity Map

Attachment B—Process Flow Diagram

Attachment C—Lucerne Valley Facility Layout

Monitoring and Reporting Program R7-2021-0023

ATTACHMENT A—VICINITY MAP

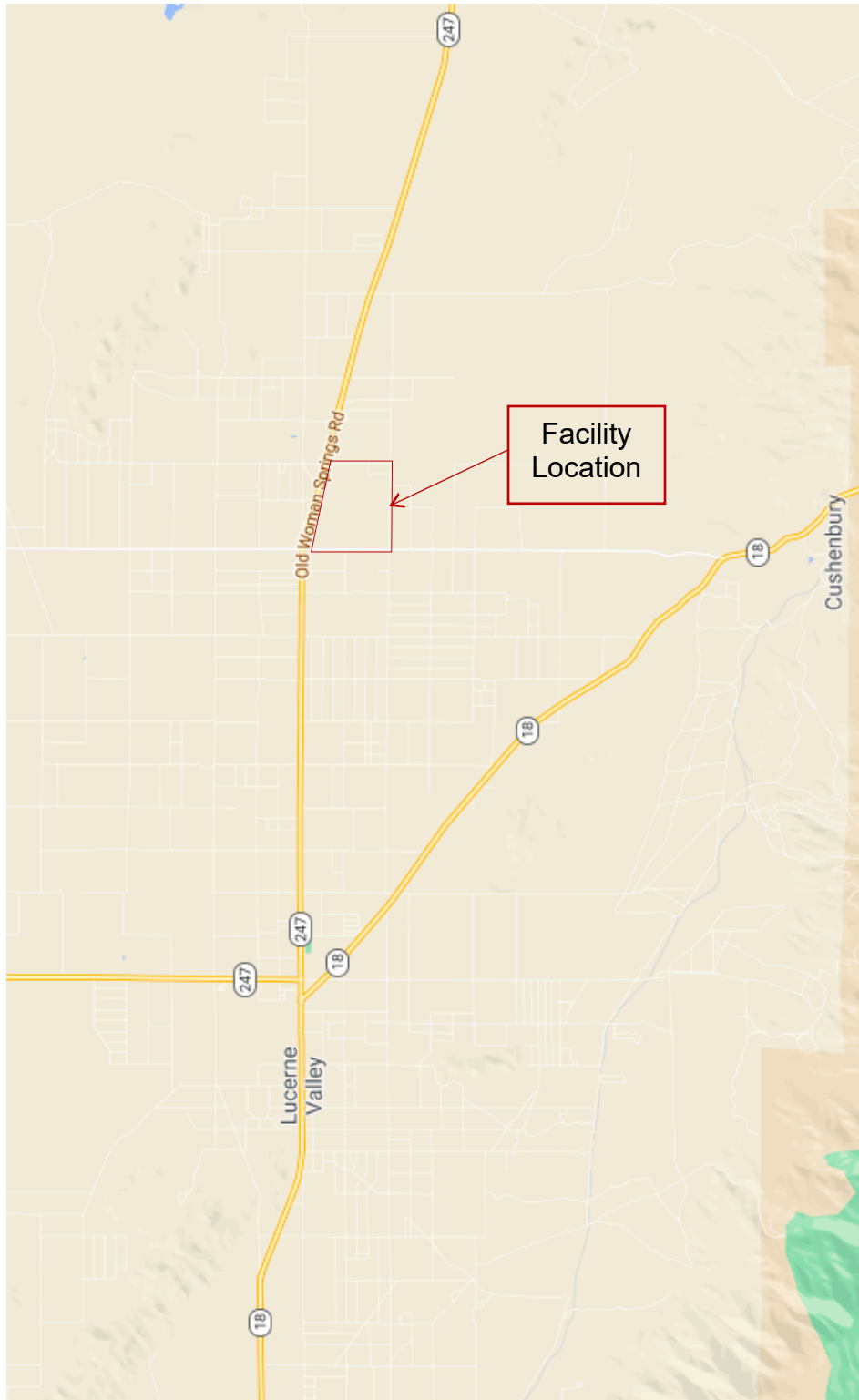

ATTACHMENT B—PROCESS FLOW DIAGRAM

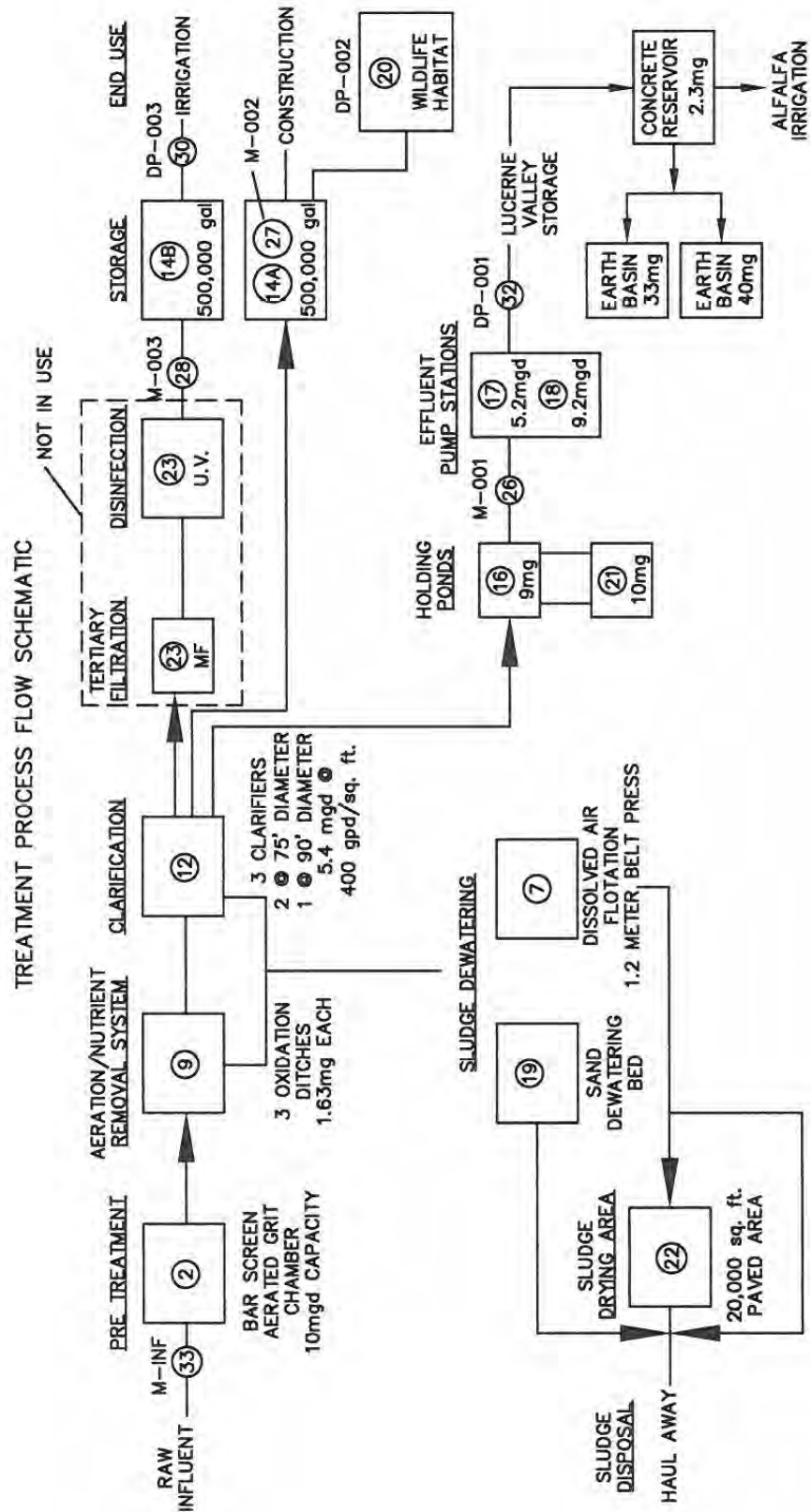

ATTACHMENT C—LUCERNE VALLEY FACILITY LAYOUT



CALIFORNIA REGIONAL WATER QUALITY CONTROL BOARD
COLORADO RIVER BASIN

MONITORING AND REPORTING PROGRAM R7-2021-0023
FOR
BIG BEAR AREA REGIONAL WASTEWATER AGENCY, OWNER/OPERATOR
EXPORT OF RECYCLED WATER TO LUCERNE VALLEY
LUCERNE VALLEY-SAN BERNARDINO COUNTY

This Monitoring and Reporting Program (MRP) is issued pursuant to Water Code section 13267 and describes requirements for monitoring the relevant wastewater system and groundwater quality. The Discharger shall not implement any changes to this MRP unless and until a revised MRP is issued by the Regional Water Board or its Executive Officer.

The Discharger owns and operates the wastewater treatment system that is subject to Order R7-2021-0023. The reports required herein are necessary to ensure that the Discharger complies with the Order. Pursuant to Water Code section 13267, the Discharger shall implement the MRP and shall submit monitoring reports described herein.

A. Sampling and Analysis General Requirements

1. **Testing and Analytical Methods.** The collection, preservation, and holding times of all samples shall be in accordance with U.S. Environmental Protection Agency (USEPA)-approved procedures. All analyses shall be conducted in accordance with the latest edition of either the USEPA's *Guidelines Establishing Test Procedures for Analysis of Pollutants Under the Clean Water Act* (40 C.F.R. part 136) or *Test Methods for Evaluating Solid Waste: Physical/Chemical Methods Compendium* (SW-846), unless otherwise specified in the MRP or approved by the Regional Water Board's Executive Officer.
2. **Laboratory Certification.** All analyses shall be conducted by a laboratory certified by the State Water Board, Division of Drinking Water's Environmental Laboratory Accreditation Program (ELAP), unless otherwise approved by the Regional Water Board's Executive Officer.
3. **Reporting Levels.** All analytical data shall be reported with method detection limits (MDLs) and with either the reporting level or limits of quantitation (LOQs) according to 40 Code of Federal Regulations part 136, Appendix B. The laboratory reporting limit for all reported monitoring data shall be no greater than the practical quantitation limit (PQL).

4. **Sampling Location(s).** Samples shall be collected at the location(s) specified in the WDRs. If no location is specified, sampling shall be conducted at the most representative sampling point available.
5. **Representative Sampling.** All samples shall be representative of the volume and nature of the discharge or matrix of material sampled. The time, date, and location of each grab sample shall be recorded on the chain of custody form for the sample. If composite samples are collected, the basis for sampling (time or flow weighted) shall be approved by Regional Water Board staff.
6. **Instrumentation and Calibration.** All monitoring instruments and devices used by the Discharger shall be properly maintained and calibrated to ensure their continued accuracy. Any flow measurement devices shall be calibrated at least once per year to ensure continued accuracy of the devices. In the event that continuous monitoring equipment is out of service for a period greater than 24 hours, the Discharger shall obtain representative grab samples each day the equipment is out of service. The Discharger shall correct the cause(s) of failure of the continuous monitoring equipment as soon as practicable. The Discharger shall report the period(s) during which the equipment was out of service and if the problem has not been corrected, shall identify the steps which the Discharger is taking or proposes to take to bring the equipment back into service and the schedule for these actions.
7. **Field Test Instruments.** Field test instruments (such as those used to test pH, dissolved oxygen, and electrical conductivity) may be used provided that:
 - a. The user is trained in proper use and maintenance of the instruments;
 - b. The instruments are field calibrated prior to monitoring events at the frequency recommended by the manufacturer;
 - c. Instruments are serviced and/or calibrated by the manufacturer at the recommended frequency; and
 - d. Field calibration reports are submitted.
8. **Records Retention.** The Discharger shall retain records of all monitoring information, including all calibration and maintenance records and all original strip chart recordings for continuous monitoring instrumentation, for a minimum of five (5) years from the date of the sampling or measurement. This period may be extended by request of the Regional Water Board's Executive Officer at any time. Records of monitoring information shall include:

- a. The date, exact place, and time of sampling or measurement(s);
- b. The individual(s) who performed the sampling or measurement(s);
- c. The date(s) analyses were performed;
- d. The individual(s) who performed the analyses;
- e. The analytical techniques or method used; and
- f. All sampling and analytical results, including:
 - i. units of measurement used;
 - ii. minimum reporting limit for the analyses;
 - iii. results less than the reporting limit but above the method detection limit (MDL);
 - iv. data qualifiers and a description of the qualifiers;
 - v. quality control test results (and a written copy of the laboratory quality assurance plan);
 - vi. dilution factors, if used; and
 - vii. sample matrix type.

9. **Inoperative Facility.** If the Facility is not in operation, or there is no discharge during a required reporting period, the Discharger shall forward a letter to the Regional Water Board indicating that there has been no activity during the required reporting period.

B. Effluent Monitoring

1. Representative samples of the undisinfected secondary recycled water shall be taken at the WWTP. The samples shall be analyzed for the following constituents and according to the following schedule:

Constituent	Units	Type of Sample	Monitoring Frequency	Reporting Frequency
Irrigation Flow	MGD	Flow Meter Reading	Daily	Monthly

Constituent	Units	Type of Sample	Monitoring Frequency	Reporting Frequency
20°C BOD ₅ ⁸	mg/L	24 Hr. Composite	2x/Month	Monthly
Total Suspended Solids (TSS)	mg/L	24 Hr. Composite	2x/Month	Monthly
pH	s.u. ⁹	Grab	Daily	Monthly
Dissolved Oxygen ¹⁰	mg/L	Grab	Monthly	Monthly
Total Dissolved Solids (TDS)	mg/L	24 Hr. Composite	Monthly	Monthly
Sulfate	mg/L	24 Hr. Composite	Monthly	Monthly
Chloride	mg/L	24 Hr. Composite	2x/Month	Monthly
Fluoride	mg/L	24 Hr. Composite	Monthly	Monthly
Nitrate as N	mg/L	24 Hr. Composite	Monthly	Monthly
Total Nitrogen	mg/L	24 Hr. Composite	Monthly	Monthly
<i>E. Coli</i>	MPN/100mL ¹¹	Grab	Monthly	Monthly
Volatile Organic Compounds (VOCs)	µg/L ¹²	24 Hr. Composite	Annually	Annually

⁸ 5-Day Biochemical Oxygen Demand at 20 degrees Celsius.

⁹ Standard pH units

¹⁰ Dissolved Oxygen shall be monitored at the upper one-foot layer of the storage or percolation ponds.

¹¹ Most Probable Number per 100 milliliters.

¹² Micrograms per liter

C. Overflow Pond Monitoring

1. During months when the overflow evaporation/percolation ponds are not used, the Discharger shall report that there has been no activity. During months when the overflow evaporation/percolation ponds are in use, the ponds shall be monitored according to the following schedule:

Constituent	Units	Type of Sample	Monitoring Frequency	Reporting Frequency
Flow	MGD	Flow Measurement	Daily	Monthly
Dissolved Oxygen	mg/L	Grab	2x/Month	Monthly
pH	s.u.	Grab	2x/Month	Monthly
Total Dissolved Solids	mg/L	Grab	2x/Month	Monthly
Freeboard	ft	Measurement	2x/Month	Monthly

D. Domestic Water Supply Monitoring

1. The domestic water supply shall be a flow weighted composite sample monitored at the water supply production wells in Big Bear Valley and include notations of which wells are non-operating for a reporting period and monitored according to the following schedule:

Constituent	Units	Type of Sample	Monitoring Frequency	Reporting Frequency
Total Dissolved Solids	mg/L	Grab	Quarterly	Quarterly
General Minerals ¹³	mg/L	Grab	Annually	Annually

¹³ General Minerals shall include: total dissolved solids, calcium, chloride, fluoride, iron, magnesium, manganese, nitrate, potassium, sodium, sulfate, barium, total alkalinity (including alkalinity series), and hardness.

E. Groundwater Monitoring

- The groundwater monitoring wells shall be monitored according to the following schedule:

Constituent	Units	Type of Sample	Monitoring Frequency	Reporting Frequency
Depth to Groundwater	ft (msl) ¹⁴	Measurement	Quarterly	Quarterly
Groundwater Gradient ¹⁵	NA	Direction	Quarterly	Quarterly
Total Nitrogen	mg/L	Grab	Quarterly	Quarterly
Nitrate as N	mg/L	Grab	Quarterly	Quarterly
Chloride	mg/L	Grab	Quarterly	Quarterly
Fluoride	mg/L	Grab	Quarterly	Quarterly
Sulfate	mg/L	Grab	Quarterly	Quarterly
<i>E. Coli</i>	MPN/100mL	Grab	Quarterly ¹⁶	Quarterly
Total Dissolved Solids	mg/L	Grab	Quarterly	Quarterly
Boron	mg/L	Grab	Quarterly	Quarterly
VOCs	µg/L	Grab	Annually	Annually

F. Reporting Requirements

- Daily, weekly, and monthly monitoring shall be included in the Monthly Self-Monitoring Reports (SMRs). Monthly SMRs shall be submitted by the **15th day of the following month**. Quarterly SMRs shall be submitted by

¹⁴ Above mean sea level.

¹⁵ Groundwater flow direction.

¹⁶ After two years of groundwater monitoring that show consistent negligible impacts to groundwater, the Discharger may request to have the monitoring schedule revised with Executive Officer approval.

January 15th, April 15th, July 15th, and October 15th. Annual SMRs shall be submitted by **January 31st** of the following year.

2. SMRs shall include, at a minimum, the following:
 - a. **Cover Letter.** A transmittal letter summarizing the essential points in the report.
 - b. **Maps.** Maps depicting the Facility layout and the location of sampling points.
 - c. **Summary of Monitoring Data.** Tables of the data collected. The tables shall include all of the data collected to-date at each monitoring point, organized in chronological order, with the oldest data in the top row and progressively newer data in rows below the top row. Each row shall be a monitoring event and each column shall be a separate parameter at a single location (or a single average, as appropriate).
 - d. **Graphical Display.** Graphs depicting monitoring parameters through time, with the concentrations being the y-axis and time being the x-axis. Logarithmic scales can be used for values that vary by orders of magnitude. Individual graphs can combine multiple locations or multiple chemicals if that allows the data to be compared more easily.
 - e. **Compliance Summary.** Identification of any violations found since the last report was submitted, and actions taken or planned for correcting each violation. If the Discharger previously submitted a report describing corrective actions and/or a time schedule for implementing the corrective actions, reference to the previous correspondence will be satisfactory. If no violations have occurred since the last submittal, this shall be stated.
3. SMRs shall be certified under penalty of perjury to be true and correct. Each SMR submitted to the Regional Water Board shall contain the following completed declaration:

"I declare under the penalty of law that I have personally examined and am familiar with the information submitted in this document, and that based on my inquiry of those individuals immediately responsible for obtaining the information, I believe that the information is true, accurate, and complete. I am aware that there are significant penalties for submitting false information, including the possibility of fine and imprisonment for knowing violations.

Executed on the _____ day of _____ at _____

_____ (Signature)

_____ (Title)"

4. The SMRs and any other information requested by the Regional Water Board shall be signed by a principal executive officer or ranking elected official. A duly authorized representative of the Discharger may sign the documents if:
 - a. The authorization is made in writing by the person described above;
 - b. The authorization specified an individual or person having responsibility for the overall operation of the regulated disposal system; and
 - c. The written authorization is submitted to the Regional Water Board's Executive Officer.
5. The results of any analysis taken more frequently than required at the locations specified in this MRP shall be reported to the Regional Water Board.
6. As specified in Standard Provision F.15, technical reports shall be prepared by or under the direction of appropriately qualified professional(s). Each technical report submitted shall contain a statement of qualification of the responsible licensed professional(s) as well as the professional's signature and/or stamp of the seal.
7. As specified in Standard Provision F.14, the Discharger shall comply with Electronic Submittal of Information (ESI) requirements by submitting all correspondence and reports required under MRP R7-2021-0023 and any future revision(s) hereto, including groundwater monitoring data and discharge location data (latitude and longitude), correspondence, and PDF monitoring reports to the State Water Board's Geotracker database. Documents too large to be uploaded into Geotracker should be broken down into smaller electronic files and labelled properly prior to uploading into Geotracker.

Big Bear Area Regional Wastewater Agency

Replenish Big Bear

Antidegradation Analysis for Proposed Discharges to Stanfield Marsh/Big Bear Lake and Shay Pond

APPENDIX B: BIG BEAR LAKE ANALYSIS: REPLENISH BIG BEAR

BIG BEAR LAKE ANALYSIS: REPLENISH BIG BEAR FINAL REPORT

Michael A. Anderson, Ph.D.
Riverside, CA

January 21, 2021

Acknowledgement of Credit

This report is financed under the Water Quality, Supply and Infrastructure Improvement Act of 2014, administered by State of California, Department of Water Resources.

Table of Contents

EXECUTIVE SUMMARY	1
I. INTRODUCTION AND STUDY OBJECTIVES.....	6
A. Project Background	6
B. Lake Background	7
C. Objectives.....	9
II. ANALYSIS OF AVAILABLE WATER QUALITY DATA	10
A. Factors Regulating Algal Productivity in Big Bear Lake	11
1. Statistical Analysis	11
2. Machine Learning.....	14
B. Internal Recycling and Hypolimnetic Mass Balance	18
III. DEVELOPMENT OF 2-D HYDRODYNAMIC- WATER QUALITY MODEL FOR BIG BEAR LAKE.....	22
A. Approach.....	23
1. Initial calibration and simulations of lake level, temperature and TDS	24
2. Calibration to Water Quality Data for Big Bear Lake	27
3. Model Calibration Results	37
IV. APPLICATION OF MODEL TO EVALUATE CONDITIONS WITH REPLENISH BIG BEAR PROJECT.	42
A. Lake Level.....	42
B. Lake Area.....	43
C. TDS.....	44
D. Nutrients and Chlorophyll-a	44
V. PREDICTED LONG-TERM FUTURE CONDITIONS WITH REPLENISH BIG BEAR PROJECT	50
A. Lake Surface Elevation	52
B. Lake Volume.....	53
C. Lake Surface Area.....	53
D. Total Dissolved Solids	55
E. Total P	56
F. Total N.....	57
G. Chlorophyll-a	58
Summary.....	59

VI. ROUTING OF SUPPLEMENTAL WATER THROUGH STANFIELD MARSH	61
VII. SUMMARY.....	63
VIII. REFERENCES.....	64

List of Figures

FIGURE 1. EFFLUENT DISCHARGE PROJECT COMPONENTS AND OVERVIEW OF DISCHARGE LOCATIONS	7
FIGURE 2. BIG BEAR LAKE TMDL SAMPLING STATION.....	10
FIGURE 3. CUMULATIVE DISTRIBUTION FUNCTIONS FOR A) CHLOROPHYLL-A, B) TOTAL P, C) TOTAL N AND D) TN:TP RATIOS FOR THE 4 TMDL SAMPLING STATIONS.....	12
FIGURE 4. PLOTS AND REGRESSION LINES BETWEEN CHLOROPHYLL-A AND A) TOTAL P, B) TOTAL N, C) TDS AND D) DEPTH BELOW FULL POOL (TMDL STATION #2, GILNER POINT).....	14
FIGURE 5. MATRIX DIAGRAM SHOWING SCATTER PLOTS BETWEEN SELECTED PARAMETERS AT TMDL STATION #1 (DAM).....	15
FIGURE 6. SCATTER PLOTS COMPARING PREDICTED (X-AXIS) AND OBSERVED (Y-AXIS) CHLOROPHYLL-A CONCENTRATIONS USING A) K-NEAREST NEIGHBOR REGRESSOR (KNR), B) RANDOM FOREST REGRESSOR (RFR), C) GRADIENT-BOOSTED REGRESSOR (GBR), AND D) MULTI-LAYER PERCEPTRON (MLP) ALGORITHMS.....	17
FIGURE 7. CONCENTRATIONS OF PO ₄ -P AND NH ₄ -N IN BOTTOM WATER SAMPLES AT TMDL STATION #1 (DAM). .	18
FIGURE 8. RELATIONSHIP BETWEEN BOTTOM WATER PO ₄ -P CONCENTRATIONS AND TEMPERATURE DIFFERENCE BETWEEN 1 M AND BOTTOM DEPTHS (ΔT OR DEL T).	19
FIGURE 9. RELATIONSHIP BETWEEN BOTTOM WATER DO CONCENTRATIONS AND TEMPERATURE DIFFERENCE BETWEEN 1 M AND BOTTOM DEPTHS (ΔT OR DEL T).	19
FIGURE 10. CE-QUAL-W2 MODEL GRID DEVELOPED FOR BIG BEAR LAKE. INSET DEPICTS AGREEMENT BETWEEN MODEL AND MEASURED VOLUME-ELEVATION RELATIONSHIPS.....	23
FIGURE 11. HYDROLOGIC TEMPORAL BOUNDARY CONDITIONS FOR MODEL CALIBRATION (2009-2019): A) TOTAL INFLOW AND B) OUTFLOWS DUE TO WITHDRAWALS AND DAM OUTFLOW (FROM WATER MASTER REPORTS).	25
FIGURE 12. PREDICTED AND OBSERVED WATER SURFACE ELEVATIONS.	25
FIGURE 13. MODEL PREDICTED AND OBSERVED WATER COLUMN TEMPERATURE PROFILES AT STATION #1 (APRIL 17 – AUGUST 6, 2009).	26
FIGURE 14. PREDICTED AND OBSERVED TDS CONCENTRATIONS.	27
FIGURE 15. CONTRIBUTING WATERSHED AREAS TO WASP SEGMENTS DEVELOPED FROM HSPF WATERSHED MODEL (TETRA TECH, 2004).	28
FIGURE 16. MODEL SEGMENTATION IN PREVIOUS WASP MODEL SIMULATIONS (TETRA TECH, 2004).	29
FIGURE 17. CE-QUAL-W2 MODEL SEGMENTATION SHOWING BRANCH, TRIBUTARY AND DISTRIBUTED INFLOWS. .	29
FIGURE 18. PLOTS AND REGRESSION LINES BETWEEN NO ₃ -N CONCENTRATIONS AND TOTAL (LAKEWIDE) FLOW FOR A) GROUT CREEK, B) KNICKERBOCKER CREEK, C) RATHBUN CREEK, AND D) SUMMIT CREEK.....	32
FIGURE 19. MODELED INPUT NUTRIENT CONCENTRATIONS IN RATHBUN CREEK: A) PO ₄ -P AND NH ₄ -N ILLUSTRATING USE OF MEASURED VALUES WHEN AVAILABLE AND MEDIAN VALUES WHEN NOT, AND B) NO ₃ -N CONCENTRATIONS DERIVED FROM REGRESSION WITH TOTAL FLOW RATE.....	33
FIGURE 20. SCHEMATIC OF 1ST-ORDER SEDIMENT SUBROUTINE IN CE-QUAL-W2.....	34
FIGURE 21. SCHEMATIC OF 0TH-ORDER SEDIMENT OXYGEN DEMAND SUBROUTINE IN CE-QUAL-W2.....	34
FIGURE 22. SCHEMATIC OF PHYTOPLANKTON SUBROUTINE IN CE-QUAL-W2.	36
FIGURE 23. PREDICTED (LINE) AND OBSERVED (CIRCLES) CHLOROPHYLL-A CONCENTRATIONS ($\mu\text{G/L}$) OVER 2009-2019 CALIBRATION PERIOD FOR TMDL SAMPLING STATIONS: A) #1 (DAM), B) #2 (GILNER POINT), C) #6 (MID-LAKE), AND D) #9 (STANFIELD). JDAY REPRESENTS SIMULATION DAY (ELAPSED JULIAN DAY) SINCE 1/1/2009.	38
FIGURE 24. PREDICTED (LINE) AND OBSERVED (CIRCLES) TOTAL P (TP) CONCENTRATIONS (MG/L) OVER 2009-2019 CALIBRATION PERIOD FOR TMDL SAMPLING STATIONS: A) #1 (DAM), B) #2 (GILNER POINT), C) #6 (MID-LAKE) AND D) #9 (STANFIELD). JDAY REPRESENTS SIMULATION DAY (ELAPSED JULIAN DAY) SINCE 1/1/2009.	38
FIGURE 25. PREDICTED (LINE) AND OBSERVED (CIRCLES) TOTAL N (TN) CONCENTRATIONS (MG/L) OVER 2009-2019 CALIBRATION PERIOD FOR TMDL SAMPLING STATIONS: A) #1 (DAM), B) #2 (GILNER POINT), C) #6 (MID-LAKE) AND D) #9 (STANFIELD). JDAY REPRESENTS SIMULATION DAY (ELAPSED JULIAN DAY) SINCE 1/1/2009.	39
FIGURE 26. EXAMPLE DISSOLVED OXYGEN PROFILES AT TMDL STATION #2 HIGHLIGHTING AGREEMENT BETWEEN PREDICTED AND MEASURED CONCENTRATIONS AND PERIODIC LOSS OF DO IN LOWER WATER COLUMN.	40
FIGURE 27. PREDICTED LAKE SURFACE ELEVATIONS OVER 2009-2019: BASELINE AND WITH PROJECT.	43
FIGURE 28. PREDICTED LAKE SURFACE AREA OVER 2009-2019: BASELINE AND WITH PROJECT.....	43

FIGURE 29. PREDICTED TDS CONCENTRATIONS OVER 2009-2019: BASELINE AND WITH PROJECT.....	44
FIGURE 30. PREDICTED CONCENTRATIONS OF A) TOTAL P, B) TOTAL N, AND C) CHLOROPHYLL-A AT TMDL STATION #2 (PHOTIC ZONE).	46
FIGURE 31. PREDICTED PLANT BIOMASS AT TMDL STATION #2 (PHOTIC ZONE). LEGEND SHOWN IN FIG. 30A.	47
FIGURE 32. CUMULATIVE DISTRIBUTION FUNCTIONS FOR PREDICTED BASELINE AND SUPPLEMENTATION SCENARIOS OF VOLUME-WEIGHTED CONCENTRATIONS OF A) TOTAL P AND B) TOTAL N.	48
FIGURE 33. THIRTY YEAR AVERAGE FLOW RATES FOR 100 RANDOM DATASETS.	51
FIGURE 34. CUMULATIVE INFLOWS UNDER 5 TH -, 50 TH - AND 95 TH -PERCENTILE 30-YR AVERAGE HYDROLOGIC SCENARIOS.	52
FIGURE 35. CDFS OF PREDICTED LAKE ELEVATIONS AT 5 TH -, 50 TH - AND 95 TH -PERCENTILE HYDROLOGIC SCENARIOS FOR A) BASELINE CONDITIONS AND B) SUPPLEMENTATION WITH REPLENISH BIG BEAR WATER.....	52
FIGURE 36. CDFS OF PREDICTED LAKE VOLUMES AT 5 TH -, 50 TH - AND 95 TH -PERCENTILE HYDROLOGIC SCENARIOS FOR A) BASELINE CONDITIONS AND B) SUPPLEMENTATION WITH REPLENISH BIG BEAR WATER.	53
FIGURE 37. CDFS OF PREDICTED LAKE AREAS AT 5 TH -,50 TH - AND 95 TH -PERCENTILE HYDROLOGIC SCENARIOS FOR A) BASELINE CONDITIONS AND B) SUPPLEMENTATION WITH REPLENISH BIG BEAR WATER.	54
FIGURE 38. LAKE SURFACE UNDER 5 TH -PERCENTILE FLOWS (PROTRACTED DROUGHT) DEPICTING AREAS UNDER BASELINE CONDITIONS (SOLID GRAY) AND WITH PROJECT (CROSS-HATCHED) AT A) MINIMUM AREA AND B) 75% EXCEEDANCE FREQUENCY (PREDICTED TO OCCUR 25% OF THE TIME UNDER THE SIMULATED PROTRACTED DROUGHT CONDITION).	54
FIGURE 39. CDFS OF PREDICTED LAKE TDS AT 5 TH -,50 TH - AND 95 TH -PERCENTILE FLOWS FOR A) BASELINE CONDITIONS, AND SUPPLEMENTATION WITH B) ALTERNATIVE 1, C) ALTERNATIVE 2 AND D) ALTERNATIVE 3 WATER.....	55
FIGURE 40. CDFS OF PREDICTED TOTAL P LEVELS AT 5 TH -, 50 TH - AND 95 TH -PERCENTILE HYDROLOGIC SCENARIOS FOR A) BASELINE, AND SUPPLEMENTATION WITH B) ALTERNATIVE 1, C) ALTERNATIVE 2 AND D) ALTERNATIVE 3 WATER.....	56
FIGURE 41. CDFS OF PREDICTED TOTAL N LEVELS AT 5 TH -, 50 TH - AND 95 TH -PERCENTILE HYDROLOGIC SCENARIOS FOR A) BASELINE CONDITIONS, AND SUPPLEMENTATION WITH B) ALTERNATIVE 1, C) ALTERNATIVE 2 AND D) ALTERNATIVE 3 WATER.....	57
FIGURE 42. CDFS OF PREDICTED CHLOROPHYLL-A LEVELS AT 5 TH -, 50 TH - AND 95 TH -PERCENTILE HYDROLOGIC SCENARIOS FOR A) BASELINE, AND SUPPLEMENTATION WITH B) ALTERNATIVE 1, C) ALTERNATIVE 2 AND D) ALTERNATIVE 3 WATER.....	58
FIGURE 43. TOTAL P CONCENTRATIONS INTO AND OUT OF STANFIELD MARSH: A) ALTERNATIVE 1, B) ALTERNATIVE 2, AND C) ALTERNATIVE 3.	61

List of Tables

TABLE 1. BENEFICIAL USES OF BIG BEAR LAKE AND STANFIELD MARSH.....	8
TABLE 2. LAKE REGULATORY LIMITS FOR CONSTITUENTS OF INTEREST	8
TABLE 3. SUMMARY STATISTICS FOR TOTAL NUTRIENTS AND CHLOROPHYLL-A CONCENTRATIONS AT THE FOUR TMDL SAMPLING STATIONS FOR 2009-2019 (PHOTIC ZONE).....	11
TABLE 4. R ² -VALUES FOR CORRELATIONS BETWEEN SELECTED WATER COLUMN PROPERTIES AND CHLOROPHYLL-A CONCENTRATIONS (ZREL FULL REPRESENTS DEPTH BELOW FULL POOL) (N=150).....	13
TABLE 5. MEAN ABSOLUTE ERROR BETWEEN PREDICTED AND OBSERVED CHLOROPHYLL-A CONCENTRATION AND VARIANCE CAPTURED BY MACHINE LEARNING AND MULTIPLE LINEAR REGRESSION MODELS (2009-2018 TRAINING SET).....	16
TABLE 6. MEAN ABSOLUTE ERROR BETWEEN PREDICTED AND OBSERVED CHLOROPHYLL-A CONCENTRATIONS AND VARIANCE CAPTURED BY MACHINE LEARNING AND MULTIPLE LINEAR REGRESSION MODELS (2019 VALIDATION SET).....	17
TABLE 7. INTERNAL NUTRIENT LOADING AND AREAL HYPOLIMNETIC OXYGEN DEMAND (AHOD) RATES MEASURED IN LABORATORY AND ESTIMATED FROM IN SITU HYPOLIMNETIC MASS BALANCE APPROACH.	20
TABLE 8. MEAN ABSOLUTE ERROR FOR MODEL PREDICTIONS OF WATER COLUMN TEMPERATURES AT THE FOUR TMDL SAMPLING STATIONS (145 PROFILES; 858-1974 DISCRETE MEASUREMENTS IN EACH PROFILE).	26
TABLE 9. MEDIAN CONCENTRATIONS (MG/L) OF NUTRIENTS AND ORGANIC C IN CREEK WATER SAMPLES.....	30
TABLE 10. RANGE IN CONCENTRATIONS (MG/L) OF NUTRIENTS AND ORGANIC C IN CREEK WATER SAMPLES.	30
TABLE 11. CORRELATION COEFFICIENTS BETWEEN FLOW AND CONSTITUENT CONCENTRATIONS.....	31
TABLE 12. 1 ST -ORDER SEDIMENT MODEL PARAMETER VALUES USED IN SIMULATIONS. DEFAULT W2 VALUES FROM WELLS (2019).	34
TABLE 13. MACROPHYTE MODEL PARAMETER VALUES USED IN SIMULATIONS.	35
TABLE 14. EPIPHYTON MODEL PARAMETER VALUES USED IN SIMULATIONS. DEFAULT W2 VALUES FROM WELLS (2019).....	36
TABLE 15. PHYTOPLANKTON MODEL PARAMETER VALUES USED IN SIMULATIONS. DEFAULT W2 VALUES FROM WELLS (2019).	37
TABLE 16. MODEL ERROR RESULTS FOR NUTRIENTS AND CHLOROPHYLL-A.	39
TABLE 17. MEAN ABSOLUTE ERROR FOR MODEL PREDICTIONS OF WATER COLUMN DO CONCENTRATIONS AT THE FOUR TMDL SAMPLING STATIONS (145 PROFILES; 858-1974 DISCRETE MEASUREMENTS IN EACH PROFILE).	40
TABLE 18. WATER QUALITY OF SUPPLEMENTAL WATER USED IN MODEL SIMULATIONS (WSC, 2020B).	42
TABLE 19. SUMMARY OF TDS CONCENTRATIONS FOR 2009-2019 UNDER NATURAL CONDITIONS AND WITH PROJECT.	44
TABLE 20. COMPARISON OF NUTRIENT CONCENTRATIONS IN WATERSHED RUNOFF AND SUPPLEMENTAL WATER WITH THE THREE TREATMENT ALTERNATIVES.	45
TABLE 21. CONCENTRATION ENRICHMENT FACTORS (SUPPLEMENTAL/WATERSHED).....	45
TABLE 22. AVERAGE CONCENTRATIONS OF NUTRIENTS AND CHLOROPHYLL-A FOR 2009-2019 PERIOD UNDER THE BASELINE SCENARIO AND WITH SUPPLEMENTATION WITH WATER FROM THE THREE TREATMENT ALTERNATIVES.....	47
TABLE 23. ANNUAL PRECIPITATION (CALENDAR YEAR) RECORDED AT BEAR VALLEY DAM AND BBCCSD. (WATER MASTER, 2019).....	50
TABLE 24. INFLUENCE OF HYDROLOGIC SCENARIOS AND SUPPLEMENTATION ON MEDIAN LAKE DIMENSIONS.	59
TABLE 25. INFLUENCE OF HYDROLOGIC SCENARIOS AND SUPPLEMENTATION WITH ALTERNATIVE LEVELS OF TREATMENT ON PREDICTED MEDIAN CONCENTRATIONS OF TDS, TOTAL N, TOTAL P AND CHLOROPHYLL-A.	59
TABLE 26. PREDICTED AVERAGE TOTAL P AND TOTAL N REMOVAL IN STANFIELD MARSH.	62

EXECUTIVE SUMMARY

Big Bear Lake is an important natural resource that provides extensive recreational, economic, ecological, and aesthetic benefits for the local community as well as the larger inland Southern California region. As with all other natural and man-made lakes in Southern California, the lake is subject to dramatic variability in water surface elevation; surface elevations reached as low as -48.5 feet (ft) relative to dam crest (72.33 ft maximum depth) in November 1961, corresponding to a volume of less than 1,000 acre-feet (af) and a lake surface area on the order of 200-300 acres during the extended drought in the late 1950's and early 1960's. Big Bear Municipal Water District (BBMWD) was subsequently formed in 1964 to manage and help stabilize the water level in Big Bear Lake. The region's natural hydrology includes severe protracted droughts and is influenced by the Pacific Decadal Oscillation (PDO) and El Nino-La Nina climate systems, which makes lake level stabilization a tremendous challenge. This wide variability in lake level, in turn, can have significant impacts on beneficial uses of the lake. Monitoring data collected primarily by the Big Bear City Community Services District (BBCCSD), BBMWD, and the Big Bear Lake Nutrient Total Maximum Daily Load (TMDL) group over the past decade underscore both the variability in regional hydrology and lake levels, and the consequences of extended periods of low runoff on water quality conditions. To minimize the impacts of frequent droughts, Replenish Big Bear was developed to recover and use a water resource currently discharged outside of the watershed.

This study assessed the overall conditions, ecological health and water quality in Big Bear Lake, and evaluated the potential influence on lake health of Replenish Big Bear. Three treatment alternative strategies (Treatment Alternatives), composed of advanced nutrient removal and reverse osmosis (RO) technologies, were evaluated:

- (i) Alternative 1: TIN & TP Removal
- (ii) Alternative 2: 70% RO (in addition to TIN & TP Removal)
- (iii) Alternative 3: 100% RO (in addition to TIN & TP Removal)

This study included an analysis of available water quality data, development of a 2-D hydrodynamic-water quality model (CE-QUAL-W2), and application of the model to evaluate lake conditions with Replenish Big Bear that focused on the period from 2009-2019. This period was selected based upon a number of factors, including the wide range of hydrologic and water quality conditions in the lake, and availability of extensive lake monitoring and meteorological data, as well as some watershed monitoring data. Model simulations from 2020-2050 were also conducted to assess possible future conditions in Big Bear Lake under different hydrologic scenarios and Replenish Big Bear discharge alternatives. The routing of Replenish Big Bear water through Stanfield Marsh was also explored in greater detail to provide better understanding of the possible role of the marsh in nutrient attenuation.

Analysis of Water Quality Data

To augment the water quality information provided in the TMDL annual reports, additional conventional statistical and advanced machine learning analyses were conducted. Analyses focused on chlorophyll-a as the key response variable. The ratio of total nitrogen (total N) to total phosphorus (total P), often used to identify nutrient limitation, confirm P-limitation principally in place regulating algal production. Correlations developed between total P, total N, total inorganic N (TIN) and chlorophyll-a for each of the 4 TMDL sampling stations (n=150 for each station) indicate relatively weak correlations with nutrient concentrations (e.g., R²-values of 0.08, 0.19, 0.21 and 0.31 between chlorophyll-a and total P for TMDL stations #1, 2, 6 and 9, respectively). R² values quantify the variance in dependent variable (chlorophyll-a) captured with the independent variable (e.g. total P), so it is clear that phytoplankton levels are a more complex function of conditions in the lake. Slightly higher R² values were in fact noted with total N (R²=0.22-0.53), while chlorophyll-a was uncorrelated with TIN. Concentration of chlorophyll-a was also relatively weakly correlated with TDS and lake level; multiple linear regression (MLR) using all these variables yielded R²-values of 0.31-0.55 depending upon TMDL sampling station.

Since significant portions of variance in observed chlorophyll-a concentrations remained uncaptured using MLR, machine learning was also evaluated. Machine learning, which is starting to be used in water quality applications, is often able to more effectively elucidate trends in complex datasets. Random forest and gradient-boosted regressor algorithms applied to TMDL station #1 data using day of year, lake level, TDS concentration and windspeed were able to capture most (0.92-0.96) of the observed variance in chlorophyll-a for the 10-yr 2009-2018 training set, notably without considering concentrations of total N or total P. For comparison, MLR using this same set of independent variables captured 0.43 of variance in observed chlorophyll-a concentrations. The gradient-boosted regressor model also demonstrated strong forecasting power, capturing 0.73 of variance in predicted chlorophyll-a concentrations of the 2019 data set (compared with 0.36 for the equivalent MLR model). Statistical analyses highlighted that multiple factors regulate chlorophyll-a concentrations in complex ways; machine learning was able to identify relationships and develop regressor models that reproduced and forecasted concentrations of chlorophyll-a with considerable accuracy.

Water column profile data were also used to quantify rates of internal nutrient recycling and areal hypolimnetic oxygen demand (AHOD). Internal nutrient recycling rates have been measured on a limited number of dates since 2002 using the laboratory core-flux method, while AHOD has not previously been measured at the lake. The *in situ* hypolimnetic mass balance approach using measured water column concentrations of ammonium as N (NH₄-N) and orthophosphate as P (PO₄-P) yielded recycling rates for 2010-2011 and 2015-2017 that were similar to previously measured values confirming the importance of nutrient recycling in lake biogeochemistry and nutrient budgets, and establishing the reliability of alum treatments in suppressing PO₄-P release. The analysis also yielded *in situ* estimates of early summer AHOD rates at TMDL station #1 of approximately 0.5 g/m²/d.

Development of 2-D Hydrodynamic-Water Quality Model

A 2-D (longitudinal-vertical) hydrodynamic -water quality model for Big Bear Lake was developed using CE-QUAL-W2. The model quantifies heat and water budgets, 2-D hydrodynamics, and predicts concentrations of nutrients, dissolved oxygen (DO), chlorophyll-a and other parameters. The 2-D (longitudinal-vertical) representation assumes the primary gradients in water column properties and water quality are in the vertical and longitudinal directions, and well-mixed in the lateral direction; model branches were added for embayments that allow a quasi-3-D representation of the lake. The model requires extensive bathymetric, hydrologic, meteorological, water quality, and other data. The 2-D laterally-averaged model grid was developed from the bathymetric survey data collected by Fugro Pelagos Inc. (2006). Hydrologic data defining inflows, outflows, and withdrawals were developed from annual Big Bear Water Master reports. Hourly meteorological conditions were taken from Big Bear Airport and California Irrigation Management Information System (CIMIS) Station #199 located at the golf course. Data included solar shortwave radiation, air temperature, dewpoint temperature, windspeed, wind direction and cloud cover. Cloud cover was determined from sky cover conditions reported in METAR data for the airport. The model was calibrated against measured lake level, *in situ* profiles of temperature and DO, and laboratory analyses of water samples collected at the lake for 2009-2019. The model was first developed and calibrated for lake level, water column temperature profiles and TDS, where generally very good agreement was achieved (mean absolute errors of 3.6 cm, 0.79-0.89 °C, and 11.9 mg/L, respectively).

Following this, model calibration to water quality data was conducted. The model included external nutrient loading from the watershed, atmospheric deposition, internal nutrient recycling, and nutrient uptake and release associated with macrophyte and epiphyton growth, senescence and death. Two algal groups were simulated, included one representing cyanobacteria capable of N₂-fixation. The 1st-order dynamic sediment model was combined with the 0th-order SOD model to simulate nutrient recycling and DO uptake in the surficial bottom sediments. Relative root mean square error was 17.7% for total P, 18.0% for total N, 29.5% for TIN, and 24.0 % for chlorophyll-a. Mean absolute errors for DO ranged from 1.02 – 1.40 mg/L for the 4 TMDL sampling stations.

Application of Model to Evaluate Conditions with Replenish Big Bear

The model was then used to predict conditions in Big Bear Lake from 2009-2019 that would reasonably be expected with water from Replenish Big Bear delivered to the lake. Supplementation of natural flows with 1,920 af/yr of Replenish Big Bear water adds about 0.2 meter (m) annually to the lake relative to levels observed in 2009-2019 (baseline), and which accrues over time such that the lake was predicted to be 1.7 m higher in late 2018 compared to the level present at that time. Supplementation also increased predicted lake volumes and surface areas, with lake area about 300 acres (16%) larger in late 2018 compared with actual area (approximately 2,200 acres vs 1,900 acres, respectively). TDS levels in the lake were strongly influenced by level of treatment and TDS concentrations in the Replenish Big Bear water; Alternative 1 water with TIN and total P removal was projected to have a TDS of 450 mg/L, while addition of RO to further treat 70% and 100% of the water (Alternatives 2 and 3) was assumed

to reduce effluent TDS to 150 and 50 mg/L, respectively. Addition of 1,920 af/yr of Alternative 1 water significantly increased TDS levels in the lake, increasing average predicted TDS from 251 mg/L for the baseline (natural) condition for 2009-2019 to 300 mg/L, while Alternatives 2 and 3 were predicted to yield lower average TDS concentrations of 244 and 226 mg/L, respectively. Exceedance of the TDS water quality objective of 175 mg/L was predicted to occur 97.6% of the time for both the baseline condition and for Alternative 2, while exceedance frequency increased to 100% for Alternative 1 and was reduced to 93.3% for Alternative 3.

Nutrient concentrations in the Replenish Big Bear water also varied markedly with treatment, with total N and total P concentrations in Alternative 1 effluent being about 6-9 times higher than median watershed concentrations, while effluent concentrations in Alternative 2 were projected to be 1.8-2.3 times larger and Alternative 3 being about 0.4-0.8 times that of median watershed values. The increased nutrient loading from Alternative 1 had a strongly detrimental effect on water quality, increasing average concentrations over 2009-2019 baseline of total N by about 50%, total P by 70%, and chlorophyll-a by 300%. In comparison, further treatment of effluent with RO yielded average concentrations comparable to (Alternative 2) or slightly improved (Alternative 3) relative to the baseline (natural no-project) condition.

Predicted Long-Term Future Conditions with Replenish Big Bear

Simulations for 2009-2019 were extended to 2050 to evaluate possible long-term conditions in the lake under natural hydrologic variability with and without supplemental water from Replenish Big Bear. Since detailed meteorological and hydrological conditions for the future are not known *a priori*, existing meteorological and flow data for 2009-2019 were used as the basis for forecasts. 2009-2019 included extreme ranges in rainfall, runoff and air temperatures; assuming this range is broadly representative of likely future meteorological and hydrologic conditions, Monte Carlo techniques were used to randomly select 100 different 30 year annual records from this set of data. From these 100 different hydrologic scenarios, the 5th-, 50th- and 95th-percentile 30 year average annual flow records and corresponding meteorological conditions were used as temporal boundary conditions for predictions of future conditions in the lake. The 5th-percentile corresponds to an average inflow rate of 8,646 af/yr and represents extended drought, while the 50th-percentile (median) corresponds to intervals of high runoff and drought (average annual inflow of 10,595 af/yr) comparable to 2009-2019, and the 95th-percentile represents a period of protracted above average rainfall and runoff (average annual inflow of 12,225 af/yr). (Note that since precipitation and runoff are log-normally distributed, the above arithmetic mean values understate the range in runoff within the simulation intervals; that is, a single high runoff year can significantly skew upward average values during a period of protracted drought.)

Supplementation with Replenish Big Bear was also predicted to increase average long-term (2009-2050) conditions in the lake that varied under the 3 hydrologic scenarios. Under the 50th-percentile hydrologic scenario, Replenish Big Bear was predicted to increase average lake level by 1.5 m, lake volume by nearly 13,000 af, and lake area by 260 acres relative to the predicted long-term baseline (no-project) condition. Water quality varied with level of treatment, with Alternative 1 nearly doubling predicted long-term average concentrations of TDS, total P and

total N and quadrupling average predicted chlorophyll-a levels. Long-term simulations indicate slight increases in average TDS, total P and total N and modest increase in chlorophyll-a for Alternative 2, and generally slight reductions or no significant change in concentrations with Alternative 3. Supplementation was predicted to have more substantial effects under the 5th-percentile runoff scenario, with increased average lake level of 3.4 m, increased volume of 16,104 af, and an additional average 638 surface acres (about 40% increase) relative to baseline. As with the median runoff scenario, supplementation with Alternative 1 effluent substantially degraded water quality, while further treatment (Alternatives 2 and 3) was predicted to result in comparable or slightly improved water quality in the lake. Effects of Replenish Big Bear were more muted at the 95th-percentile runoff scenario, when supplementation is less important, owing to the lower overall contributions of water and TDS and nutrients relative to the watershed.

Routing of Supplemental Water Through Stanfield Marsh

Simulations with Replenish Big Bear involved routing of effluent through Stanfield Marsh, where some nutrient uptake could be expected. Simulations indicate net removal of total P through the Marsh with Alternative 1 and Alternative 2 effluent, while simulations predicted that the Marsh would be a modest source of total P to Alternative 3 water with very low influent concentrations. Interestingly, the Marsh was predicted to be a source of total N across all levels of treatment, due to sediment decay, and some N₂-fixation and subsequent decay in response high PO₄-P concentrations and high TN:TP ratios in the effluent. Further work is needed, however, to better understand the role of the Marsh as a net sink and/or source for nutrients.

Summary

Lake conditions and water quality in Big Bear Lake varied significantly over 2009-2019, with wide variations in lake level, volume and surface area, as well as concentrations of TDS, nutrients and chlorophyll-a. Statistical, machine learning and hypolimnetic mass balance analyses provided valuable new information about water quality in Big Bear Lake, while CE-QUAL-W2 was able to reproduce observed trends in lake conditions. Supplementation of natural runoff with Replenish Big Bear water significantly increased lake levels, volumes and surface areas, especially during periods of drought, with resulting recreational, aesthetic, community and related benefits. The level of treatment had dramatic effects on water quality, however. Nutrient removal (Alternative 1) was not sufficient to protect water quality, although nutrient removal with further treatment (Alternatives 2 and 3) was predicted to yield water quality comparable to or slightly improved relative to baseline conditions.

I. INTRODUCTION AND STUDY OBJECTIVES

The Replenish Big Bear Team, a collaborative regional water resources program being implemented by Big Bear Area Regional Wastewater Agency (BBARWA), Big Bear City Community Services District (BBCCSD), Big Bear Lake Department of Water and Power (BBLDWP), Big Bear Municipal Water District (BBMWD) and the Bear Valley Basin Groundwater Sustainability Agency (BVBGSA), engaged Professor Emeritus Michael A. Anderson (Dr. Anderson), who has in-depth knowledge of the Big Bear Lake (Lake), to evaluate the Lake water quality conditions and assess the potential impacts of the Replenish Big Bear project. This study was prepared in response to the Santa Ana Regional Water Quality Control Board (Santa Ana Water Board) staff's need to have a better understanding of the Lake's health to consider approving a discharge above current Basin Plan water quality objectives (WQOs) or the Nutrient Total Maximum Daily Load (Nutrient TMDL) for Dry Hydrologic Conditions.

This study assesses the overall conditions, ecological health, and water quality in Lake, and evaluates the potential influence on lake health of three treatment alternative strategies (Treatment Alternatives) to supplement the natural water supply to the lake. These Treatment Alternatives are composed of advanced nutrient removal and reverse osmosis (RO) technologies:

- (i) Alternative 1: TIN & TP Removal
- (ii) Alternative 2: 70% RO(70% RO + 30% TIN & TP Removal)
- (iii) Alternative 3: 100% RO

A. Project Background

Replenish Big Bear was developed in an effort to help protect Big Bear Valley (Valley) and the Santa Ana Watershed from the impacts of drought and variable precipitation by recovering a water resource currently discharged outside of the watershed. Replenish Big Bear is comprised of three independent projects, which will be implemented separately in the following progression, as practicable:

- Effluent discharge to Stanfield Marsh (and subsequently to the Lake) and Shay Pond;
- Use of Lake water for landscape irrigation of the local golf course; and
- Use of Lake water for groundwater recharge in Sand Canyon.

The first project, and primary regulatory driver, includes treatment upgrades at the BBARWA wastewater treatment plant (WWTP) to produce highly treated effluent for discharge to Shay Pond and Stanfield Marsh, which flows into the lake. This study evaluates the water quality in the lake and assesses impacts of discharge through Stanfield Marsh. For redundancy purposes, BBARWA is also seeking to maintain its current discharge location in Lucerne Valley, where undisinfected secondary effluent is currently conveyed to irrigate crops used for livestock feed. These new discharge points will allow BBARWA to minimize discharge of treated effluent outside of the watershed, which will increase Lake levels to better support beneficial uses including recreation and habitat, particularly in times of drought. Additionally, discharge to Shay Pond will replace potable water currently discharged to maintain the water flow through the pond. Figure

1 shows the project components for this first project, which is referred to as the effluent discharge project.

The other two projects will utilize lake water for (i) landscape irrigation at the local golf course to achieve in lieu recharge of the groundwater basin and (ii) direct groundwater recharge in Sand Canyon. These projects are not planned for any time soon.

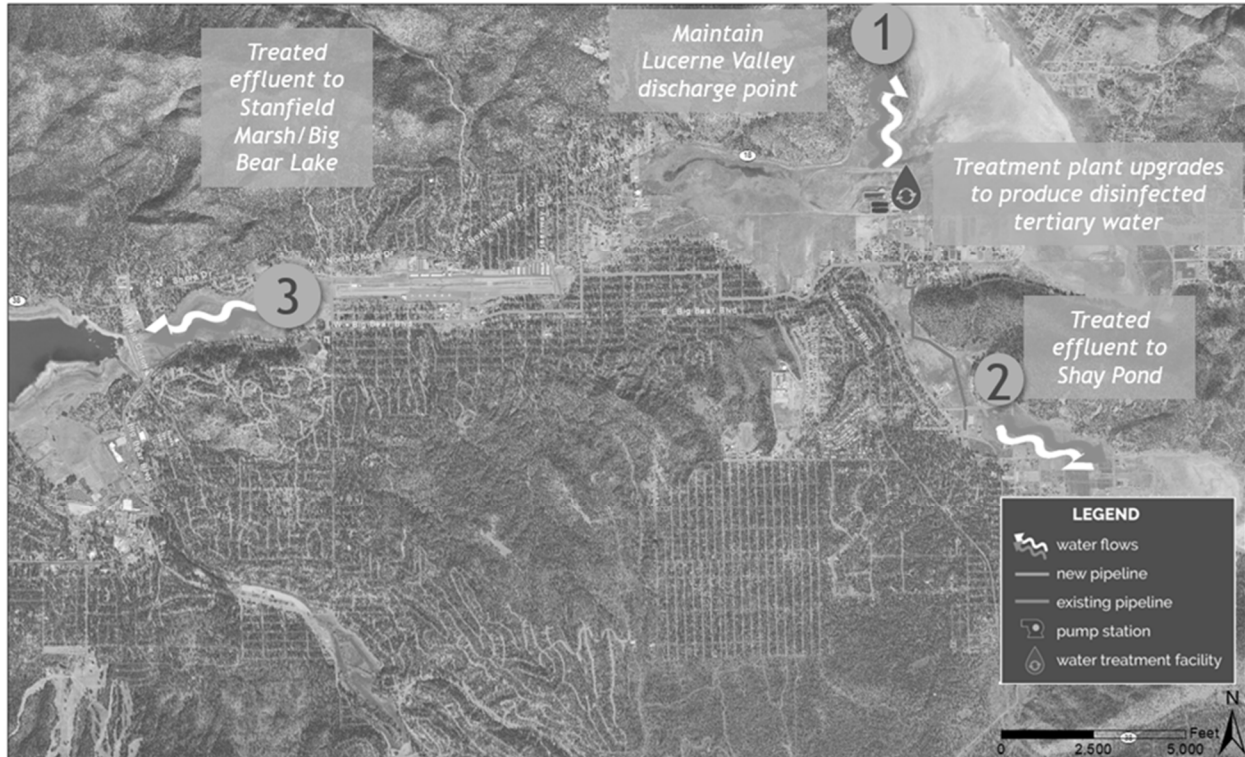

Figure 1. Effluent discharge project components and overview of discharge locations

B. Lake Background

Big Bear Lake is an important resource that provides extensive recreational, economic, ecological, and aesthetic benefits for the local community as well as the larger inland southern California region. Together, Stanfield Marsh and the Lake have a surface area of nearly 3,000 acres, a storage capacity of 73,320 af, and an average depth of 32 feet (ft). Stanfield Marsh and the Lake are both waters of the State of California (State) and United States (U.S.), which have several designated beneficial uses. For reference, Table 1 shows the designated beneficial uses of the Lake and Stanfield Marsh per the 1995 Water Quality Control Plan for the Santa Ana Basin Plan (Basin Plan), as amended in 2008, 2011, 2016, and 2019. In addition, the Nutrient TMDL was adopted to address concerns with phosphorus and nitrogen impacts on the lake. Table 2 presents the Lake regulatory limits set to protect the Lake benefits.

Final Report

Beneficial Uses	Big Bear Lake	Stanfield Marsh
AGR - Agricultural Supply	✓	
COLD - Cold Freshwater Habitat	✓	✓
GWR - Groundwater Recharge	✓	
MUN - Municipal and Domestic Supply	✓	✓
RARE - Rare, Threatened, or Endangered Species	✓	✓
REC1 - Water Contact Recreation	✓	✓
REC2 - Non-Contact Water Recreation	✓	✓
SPWN - Spawning, Reproduction, and/or Early Development	✓	
WARM - Warm Freshwater Habitat	✓	
WILD - Wildlife Habitat	✓	✓

Constituent	Basin Plan WQO (mg/L)	Nutrient TMDL (mg/L)
Total Dissolved Solids (TDS)	175	
Hardness	125	
Sodium	20	
Chloride	10	
Total Inorganic Nitrogen (TIN) (mg/L-N)	0.15	
Sulfate	10	
Total Phosphorus (TP) (mg/L-P)	0.15	0.035
Total Nitrogen (TN) (mg/L-N)		1
Chlorophyll-a (µg/L)		14

Note: **Bolded** constituents were identified as priority in previous regulatory meetings and are specifically evaluated in this study.

The Lake is located about 6,743 ft (2,055 m) above mean sea level (MSL) in the San Bernardino Mountains in San Bernardino County. The Lake was formed following construction of the Bear Valley Dam in 1883-1884 to serve as an irrigation supply for the citrus industry in the downstream Redlands-San Bernardino communities. Since that time, the Lake has served as a vital engine for economic growth in the Valley, and the region has developed into a year-round destination with extensive recreational and commercial activities, primary and secondary residences, vacation properties and hospitality, and other services.

As with all other natural and man-made lakes in Southern California, the Lake is subject to dramatic variability in water surface elevation; surface elevations reached as low as -48.5 ft relative to dam crest (72.33 ft maximum depth) in November 1961, corresponding to a volume of less than 1,000 af and a lake surface area on the order of 200-300 acres during the extended drought in the late 1950's and early 1960's. BBMWD was subsequently formed in 1964 to manage and help stabilize the water level in the Lake. The region's natural hydrology includes severe protracted droughts and is influenced by the Pacific Decadal Oscillation (PDO) and El Nino-La Nina climate systems (Kirby, 2010), which makes lake level stabilization a tremendous challenge.

This wide variability in Lake level, in turn, can have dramatic impacts on recreational, economic, and aesthetic values of the Lake, as well as ecological conditions and Lake water quality.

Monitoring data collected over the past decade underscore both the variability in regional hydrology and Lake levels, and the consequences of extended periods of low runoff for water quality conditions in the Lake.

C. Objectives

This study (i) analyzed available historical data on Lake conditions to improve quantitative understanding of water quality in the Lake and the interactions and relationships of key causal and response parameters through statistical and advanced machine learning approaches; (ii) developed and calibrated a 2-D hydrodynamic-water quality model using available historical data to develop an improved process-level understanding of water quality; (iii) assessed conditions in the Lake under natural variable hydrology and climate change through the application of the 2-D hydrodynamic water quality model; and (iv) evaluated, through model simulations, Lake conditions with different treatment alternatives for the proposed Replenish Big Bear project. Phosphorus, nitrogen and total dissolved solids (TDS) are the primary constituents of interest with respect to impacts to the Lake and its beneficial uses.

II. ANALYSIS OF AVAILABLE WATER QUALITY DATA

As illustrated in the Baseline Assessment Tech Memo (WSC, 2020), the Lake is subject to widely varying lake volumes and wide ranges in nutrient, TDS, and chlorophyll-a concentrations. Extension of the analysis provided in the Baseline Assessment Tech Memo (WSC, 2020) was conducted to include additional calculations, regressions, and machine learning to better understand the factors, relationships, and interactions governing water quality. Field and laboratory data for TMDL stations #1 (Dam), #2 (Gilner Point), #6 (Mid-lake) and #9 (Stanfield) over the 2009-2019 time period formed the basis for the analyses. These monitoring stations are shown in Figure 2.

Linear regressions and other statistical analyses are commonly used to identify factors affecting water quality in lakes. Machine learning is now starting to be used for water quality assessments (Chou et al., 2018; Ahmed et al., 2019), including short-term forecasting of algal blooms (Park et al., 2015), owing its ability to often elucidate relationships within complex datasets. Supervised machine learning requires a robust dataset on which to train and validate models. BBMWd has developed and maintained a high quality Lake monitoring program, and has an excellent dataset that was used to train and test different supervised machine learning models. This dataset provides an empirical, data-based approach to identifying and understanding relationships between causal and response variables and predicting water quality in the Lake.

Data were also used where possible to quantify rates of important processes operating within the Lake. For example, increases in total P and total inorganic nitrogen (TIN) concentrations are routinely recorded in late summer/early fall that are thought to be associated with lake mixing (WSC, 2020). Hypolimnetic and/or water column mass balance calculations often allow calculation of internal nutrient recycling rates from bottom sediments (Cooke et al., 2005). Such calculations also provide comparisons with previous laboratory core-flux measurements (Anderson and Dyal, 2003), and allow evaluation of effects of runoff, lake level, and other factors on internal nutrient loading, which is recognized as an important source of nutrients to the Lake (contributing, for example, an estimated 52% of total nitrogen and total P loading under a dry scenario) (Santa Ana Water Board, 2005).

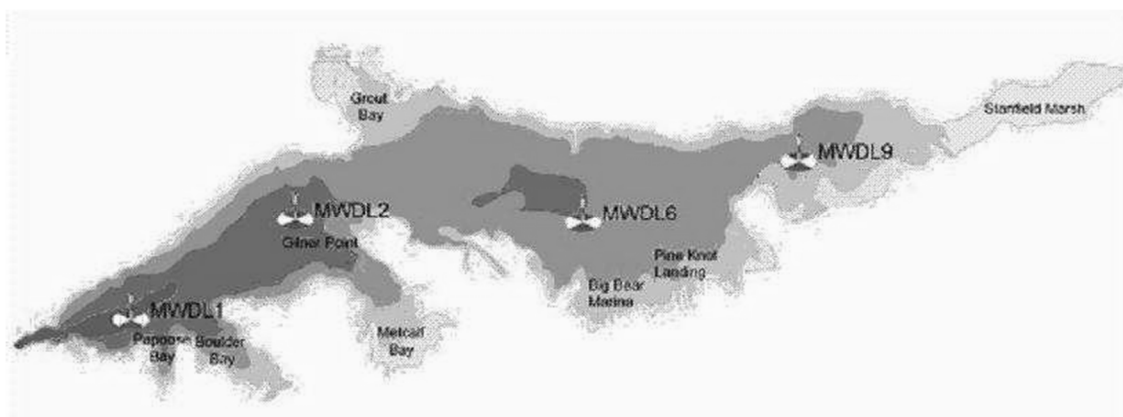

Figure 2. Big Bear Lake TMDL sampling station.

A. Factors Regulating Algal Productivity in Big Bear Lake

1. Statistical Analysis

The TMDL annual water quality reports provide water quality reports, time-series data, and summary statistics, so this section focuses on select statistical analyses of TMDL water quality data. The Lake is generally considered to be P-limited; the ratio of TN to TP concentrations (TN:TP ratio) is reflective of the elemental composition of phytoplankton, with P-limitation generally recognized at TN:TP ratios >20, and N-limitation at TN:TP ratio <5 (Thomann and Mueller, 1998). Photic zone TN and TP concentrations for the 2009-2019 time period were used to calculate TN:TP ratios at the four stations to confirm that P-limitation typically exists in the Lake. Median TN:TP ratios were 27-28 at the Dam, Gilner Point, and Mid-lake stations, but somewhat lower (21.1) at the Stanfield station (Table 3). The TN:TP ratios exhibited considerable variability, so values have been plotted as cumulative distribution functions (Figure 3). Based on these data, the Lake can be considered to be P-limited about 70% of the time and co-limited about 30% of the time. By this measure, N-limitation was present only 1-2% of the time, thus supporting efforts to constrain external loading and internal recycling of P in the Lake.

Parameter	Value	Dam	Gilner Point	Mid-Lake	Stanfield
Total P	Median	0.036	0.040	0.040	0.051
	25-75%	0.024 – 0.050	0.024 – 0.060	0.026 – 0.068	0.033 – 0.088
	Min-Max	0.005 – 0.150	0.005 – 0.210	0.005 – 0.200	0.008 – 0.400
Total N	Median	1.12	1.10	1.16	1.22
	25-75%	0.92 – 1.26	0.93 – 1.27	0.94 – 1.33	0.96 – 1.53
	Min-Max	0.028 – 2.14	0.19 – 3.25	0.17 – 2.43	0.28 – 2.89
Chlorophyll-a	Median	9.4	10.9	11.7	15.1
	25-75%	6.1 – 14.6	6.7 – 16.0	7.5 – 16.5	8.8 – 27.0
	Min-Max	0.9 – 51	0.5 – 205	2.0 – 106	1.8 – 150
TN:TP	Median	28.2	27.3	27.2	21.2
	25-75%	19.1 – 40.4	18.9 – 38.2	17.4 – 39.0	14.8 – 30.8
	Min-Max	7.3 – 162	3.4 – 244	4.0 – 284	3.5 – 147

Final Report

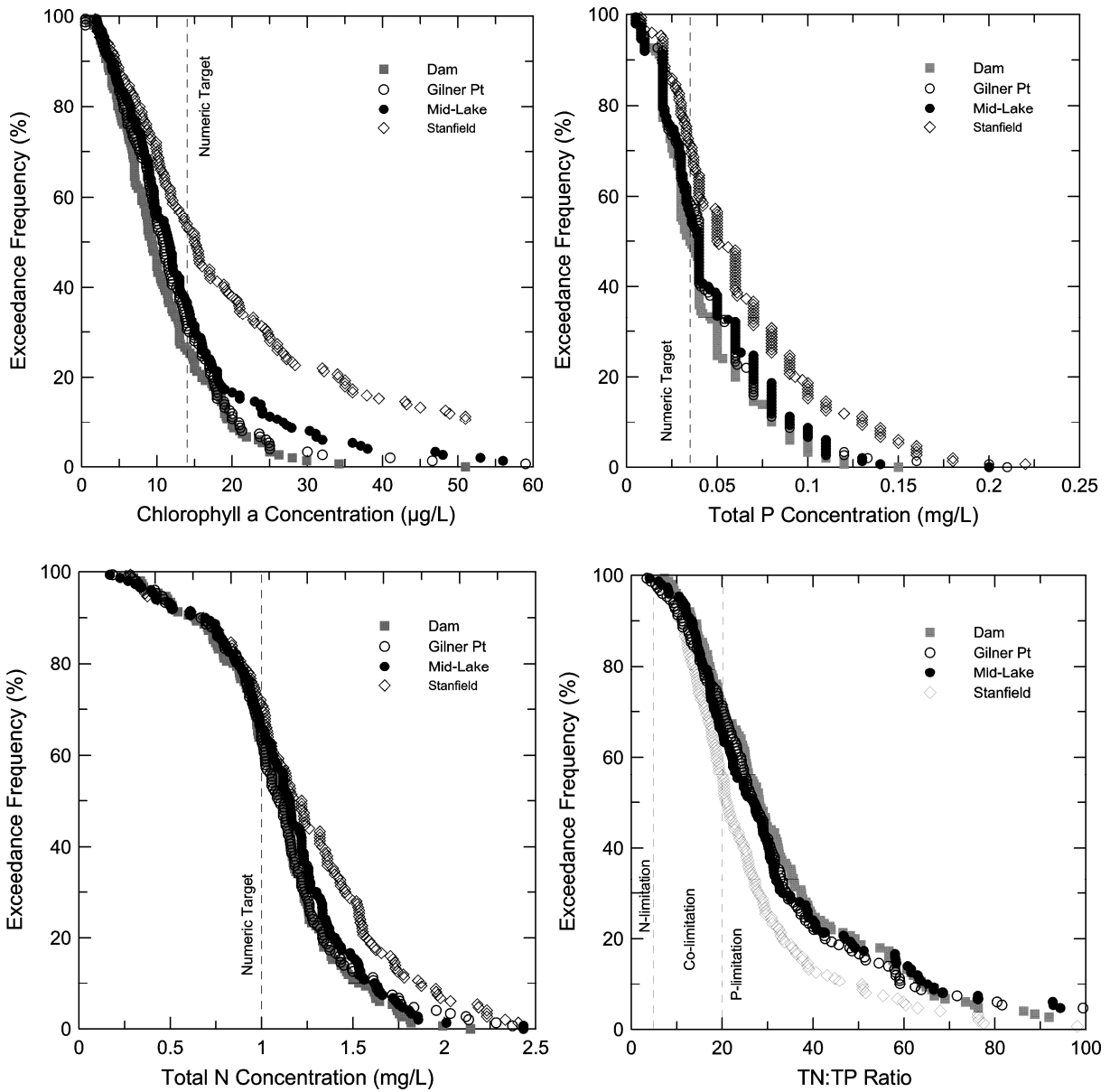

Figure 3. Cumulative distribution functions for a) chlorophyll-a, b) total P, c) total N and d) TN:TP ratios for the 4 TMDL sampling stations.

Final Report

Correlations between chlorophyll-a concentrations and selected water column properties indicate that no single property captures a substantial amount of the variance in observed chlorophyll-a concentration for all four sampling stations, although the Stanfield station was somewhat more responsive to nutrient concentrations than the other stations (Table 4). Interestingly, TP concentration captured a smaller fraction of observed chlorophyll-a variance than TN (0.08-0.31 vs 0.22-0.53, respectively). Depth below full pool appears to be a useful attribute that integrates across a number of lake conditions and captured, on average, slightly more of the variance (larger R^2) in chlorophyll-a concentrations across all sites ($R^2 = 0.22$) compared with TP ($R^2=0.21$) (Table 4). Multiple linear regression using all of these parameters yielded limited improvements in R^2 values compared with single values, indicating that a substantial amount of variance in chlorophyll-a concentration is unaccounted for using basic water quality (and lake level) information (Table 4). Results are very similar when considering only summer months (Jun-Sep) (data not shown). In general, there was no strong correlation between chlorophyll-a and the parameters evaluated.

Table 4. R^2 -values for correlations between selected water column properties and chlorophyll-a concentrations ($Z_{rel\ full}$ represents depth below full pool) (n=150).						
Station	TN	TP	TIN	TDS	$Z_{rel\ full}$	All
Dam	0.22	0.08	0.05	0.17	0.29	0.31
Gilner Pt	0.31	0.19	0.00	0.25	0.32	0.43
Mid-Lake	0.34	0.21	0.00	0.19	0.25	0.40
Stanfield	0.53	0.31	0.04	0.18	0.22	0.55

Plots for Gilner Point highlight the variability in chlorophyll-a concentrations as a function of TP, TN, and TDS concentrations and depth below full pool ($Z_{ref\ full}$) across the wide ranging conditions present in the Lake over the 2009-2019 period (Figure 4).

Final Report

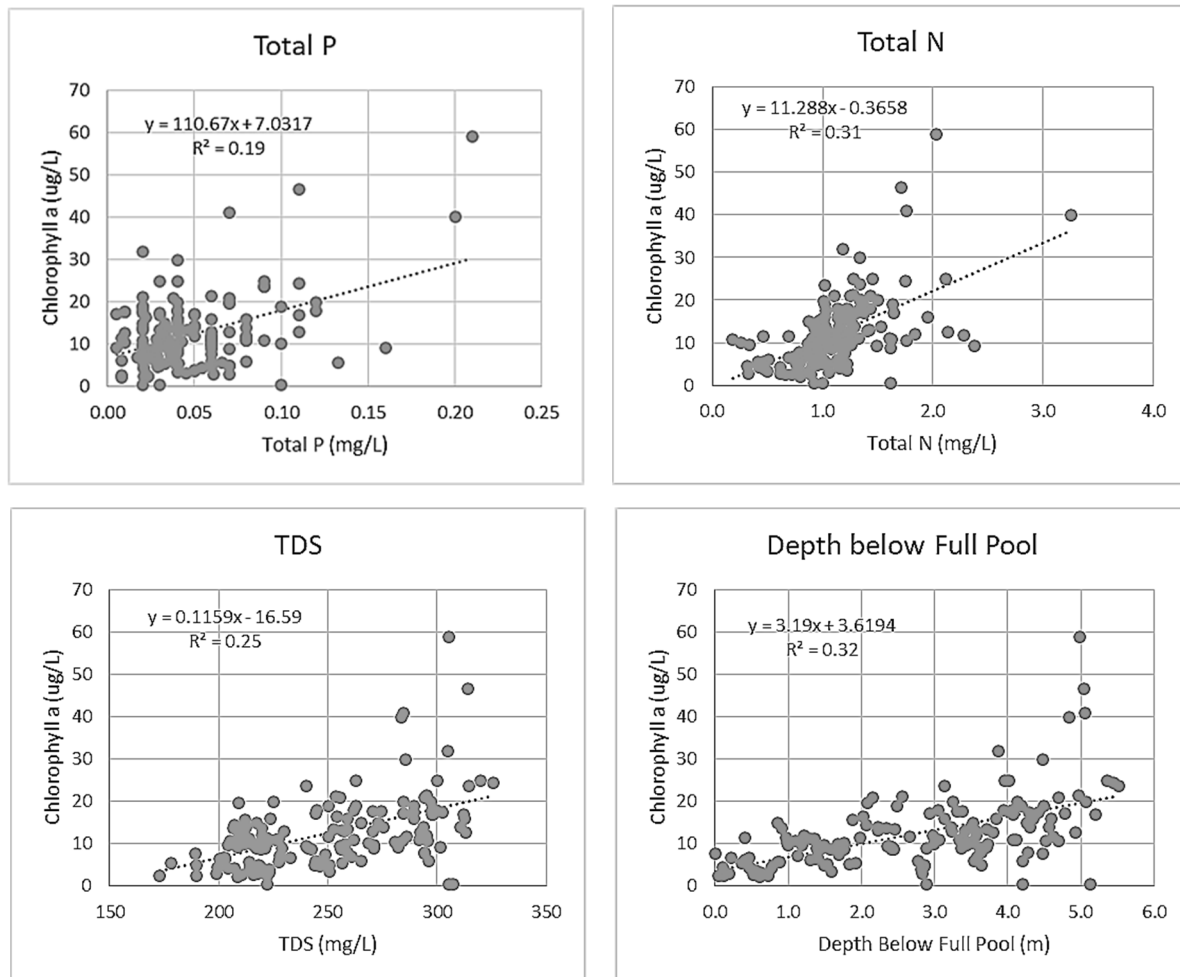

Figure 4. Plots and regression lines between chlorophyll-a and a) total P, b) total N, c) TDS and d) depth below full pool (TMDL station #2, Gilner Point).

2. Machine Learning

Linear regression equations reflected general trends indicating increases in chlorophyll-a in response to increased concentrations of nutrients, TDS, and decreasing lake level, but only captured a relatively small proportion of the variability in measured chlorophyll-a concentrations. Machine learning is often able to more effectively elucidate trends in complex datasets. Random forest and gradient boosted regression trees, k-nearest neighbor, and neural net models were developed using Python 3.7 scikit-learn (e.g., Mueller and Guido, 2017). The machine learning algorithms were trained on the 10-yr record from 2009-2018 (inclusive) and then used to predict water quality for 2019 for comparison with observed conditions.

Chlorophyll-a was the target variable in the machine learning analysis since it represents the key response variable for water quality in the Lake. Independent variables (“features”) evaluated included total and dissolved N and P concentrations, water temperature, day of year, lake level

Final Report

(depth below full pool), TDS concentration, and wind speed (U_w). Model goodness-of-fit was determined based on mean absolute error (MAE) and variance captured. Interestingly, nutrient concentrations and water temperature contained less value in predicting chlorophyll-a concentrations than day of year, lake level, TDS, and average wind speed. The relationships between these features and chlorophyll-a concentration at TMDL Station #1 (dam) in the training data are graphically represented in Figure 5.

The lowest set of panels in the following matrix diagram are scatter plots of chlorophyll-a (Chl) as a function of day of the year (Day), lake level below full pool (Level), TDS, and average windspeed (U_w). Visually one notes that chlorophyll-a exhibits trends of increased concentrations with increasing depth below full pool and increased TDS, although extremely large variability in chlorophyll-a concentrations exists at any given value of lake level or TDS. The final panel on the lower right side of the figure represents a frequency histogram, illustrating that most chlorophyll-a values were around 5-10 $\mu\text{g/L}$ (*i.e.*, below the TMDL target of 14 $\mu\text{g/L}$), with very few observations at this station $>25 \mu\text{g/L}$ (Figure 5).

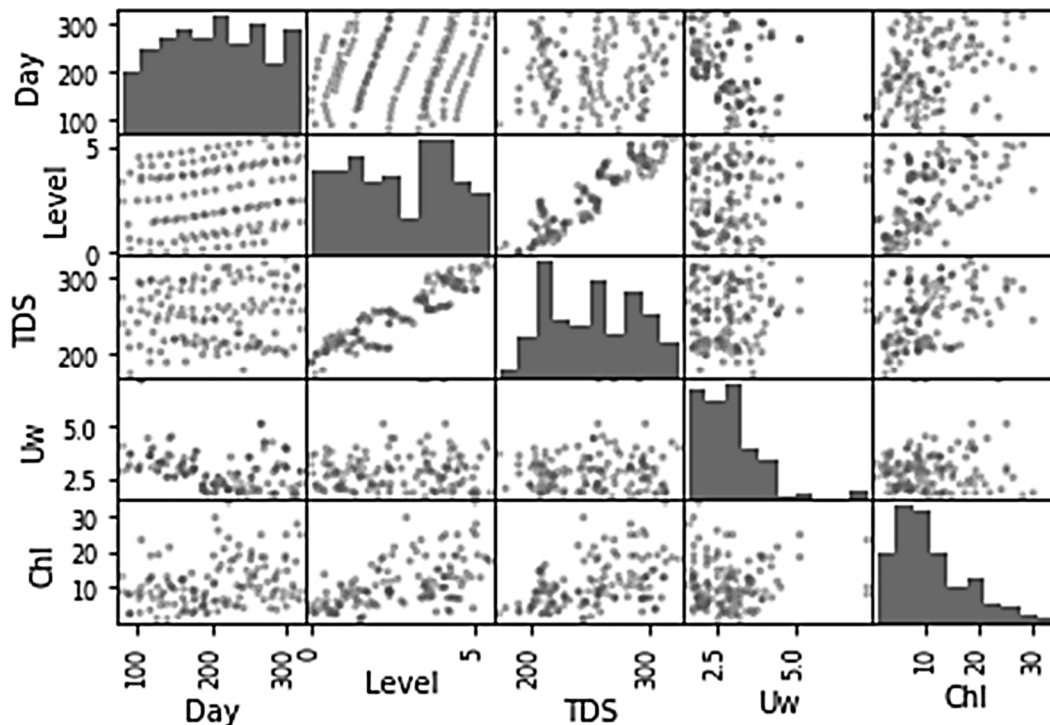

Figure 5. Matrix diagram showing scatter plots between selected parameters at TMDL station #1 (dam).

Application of the random forest regressor (RFR) and gradient-boosted regressor (GBR) using Day-Level-TDS-Windspeed as features yielded models that much more accurately reproduced observed chlorophyll-a concentrations and captured more than 90% of the variance (Figure 6, Table 5). Multiple linear regression using an expanded parameter set yielded a model that was

only better than the multi-layer perceptron (MLP) model, which actually generated excess variance.

Table 5. Mean absolute error between predicted and observed chlorophyll-a concentration and variance captured by machine learning and multiple linear regression models (2009-2018 training set).		
Model (TMDL station #1)	MAE ($\mu\text{g/L}$)	Variance Captured
K-Nearest Neighbor (KNN)	3.4	0.52
Random Forest Regressor (RFR)	1.4	0.92
Gradient-Boosted Regressor (GBR)	1.0	0.96
Multi-Layer Perceptron (MLP)	14.8	-3.2
Multiple Linear Regression	3.3	0.43

The RFR and GBR models captured >90% of the variance in observed chlorophyll-a concentrations without incorporation of nutrient data (using only Day-Level-TDS-Uw), and mean absolute error (MAE) values were only about 30-40% that of the multiple linear regression model (Table 6).

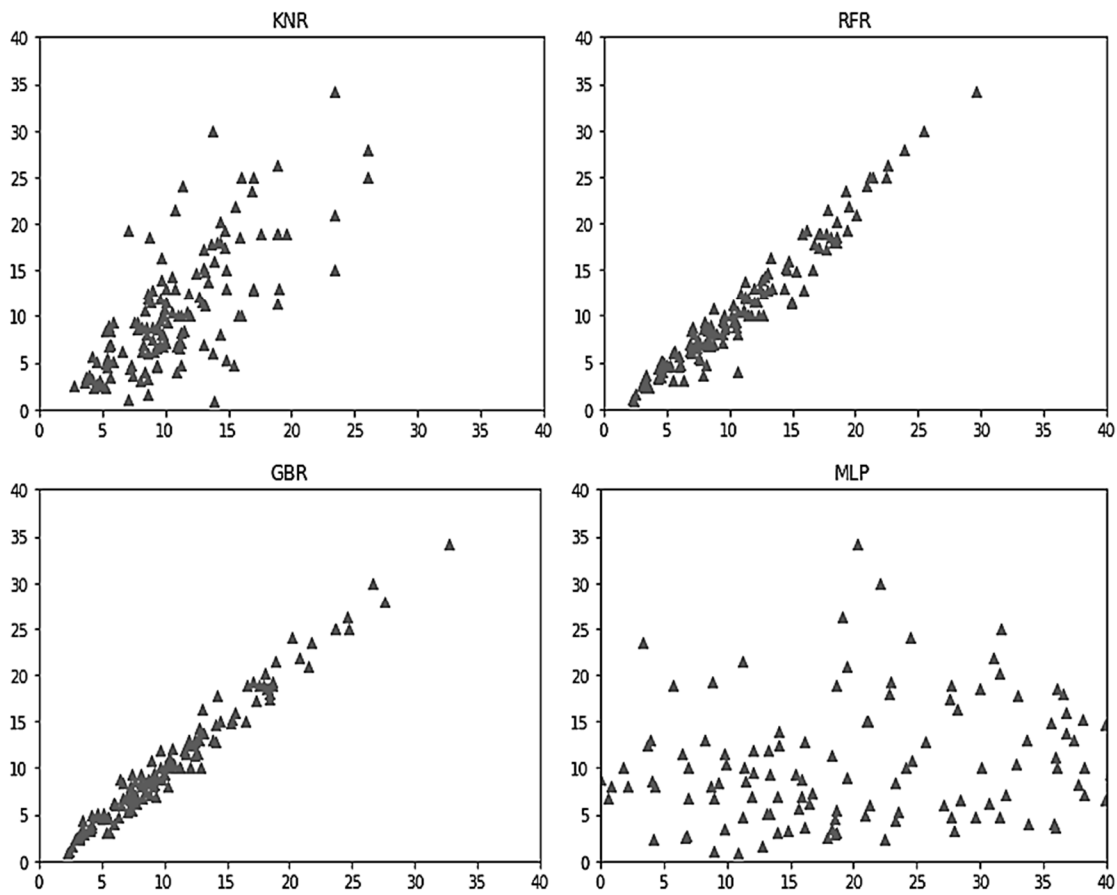

Figure 6. Scatter plots comparing predicted (x-axis) and observed (y-axis) chlorophyll-a concentrations using a) k-nearest neighbor regressor (KNR), b) random forest regressor (RFR), c) gradient-boosted regressor (GBR), and d) multi-layer perceptron (MLP) algorithms.

The RFR and GBR models had significant predictive power for 2019, capturing 58% and 73% of the variance in observed chlorophyll-a (compared with only 36% for the multiple linear regression model), although MAE values were much higher than the 2009-2018 training set. (For reference, a temperature-nutrient model captured <10% of variance in observed chlorophyll-a, underscoring the complex relationships governing algal productivity in the Lake.)

Table 6. Mean absolute error between predicted and observed chlorophyll-a concentrations and variance captured by machine learning and multiple linear regression models (2019 validation set).		
Model (TMDL #1)	MAE (µg/L)	Variance Captured
Random Forest Regressor (RFR)	4.5	0.58
Gradient-Boosted Regressor (GBR)	5.9	0.73
Multiple Linear Regression	6.3	0.36

B. Internal Recycling and Hypolimnetic Mass Balance

Internal nutrient recycling is recognized as an important part of the nutrient budget of the Lake (Santa Ana Water Board, 2005). Ortho-phosphate-P ($\text{PO}_4\text{-P}$), sometimes also referred to as soluble reactive P (SRP), is released from bottom sediments via reductive dissolution of ferric iron-bound phosphate phases under anoxic conditions and through microbially-mediated dephosphorylation of organic matter. Similarly, $\text{NH}_4\text{-N}$ is released from bottom sediments by deamination of organic matter. Under stratified conditions, $\text{PO}_4\text{-P}$ and $\text{NH}_4\text{-N}$ accumulate in the hypolimnion and their increase in concentrations allows calculation of *in situ* recycling rates.

Station #1 nearest the dam is the deepest of the four main sampling stations and is often observed to exhibit some thermal stratification during the spring through early-mid summer. One consequence of the development of thermal stratification is that nutrients released from sediments accumulate in the bottom waters and their concentrations increase over time, with $\text{NH}_4\text{-N}$ and $\text{PO}_4\text{-P}$ reaching, *e.g.*, up to 0.8 mg/L and 0.2 mg/L in the summer of 2010 (Figure 7).

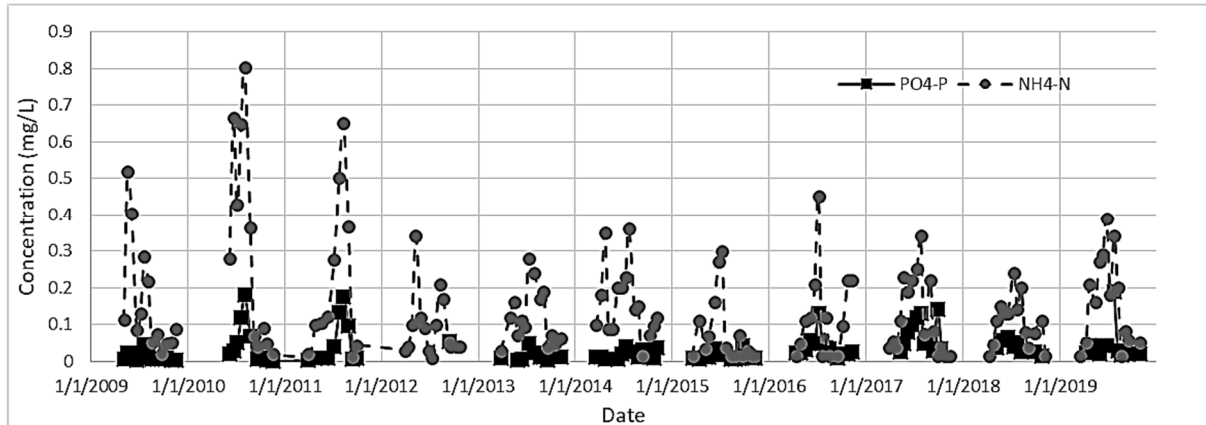

Figure 7. Concentrations of $\text{PO}_4\text{-P}$ and $\text{NH}_4\text{-N}$ in bottom water samples at TMDL station #1 (dam).

The concentrations in bottom waters tracked quite closely the magnitude of stratification, represented by ΔT (the difference in temperature between the 1 m and bottom depths) (*e.g.*, Figure 8). That is, concentrations tended to increase with increasing ΔT , while mixing of the water column (ΔT near 0°C) was associated with sharp reductions in dissolved nutrients due to their mixing throughout the water column.

Final Report

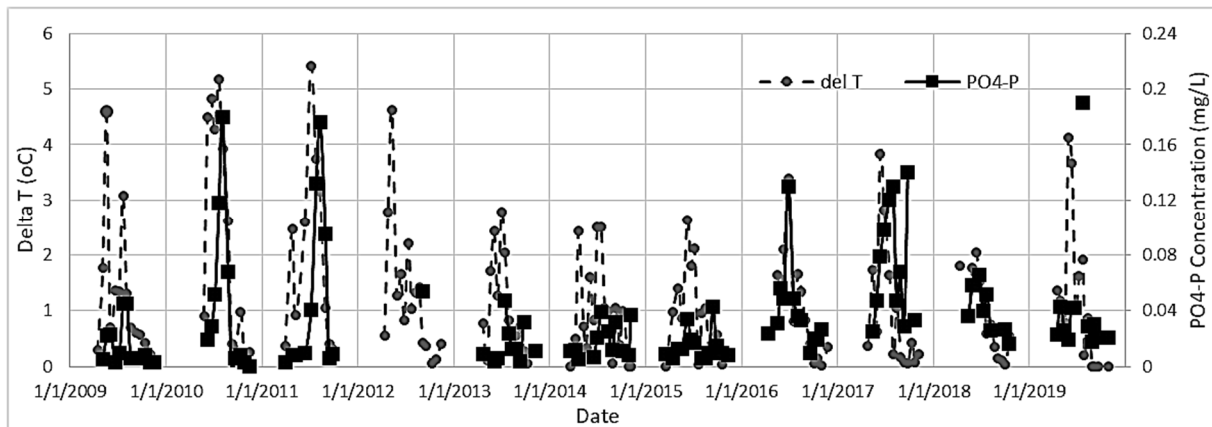

Figure 8. Relationship between bottom water $PO_4\text{-P}$ concentrations and temperature difference between 1 m and bottom depths (ΔT or del T).

Stratification also results in widely-recognized loss of dissolved oxygen (DO), as aerobic bacteria consume DO; with DO unable to be replenished through exchange with the upper well-aerated mixed portion of the water column (epilimnion), oxygen demand quickly depletes DO in the hypolimnion, and is restored when the water column mixes later in the summer (Figure 9).

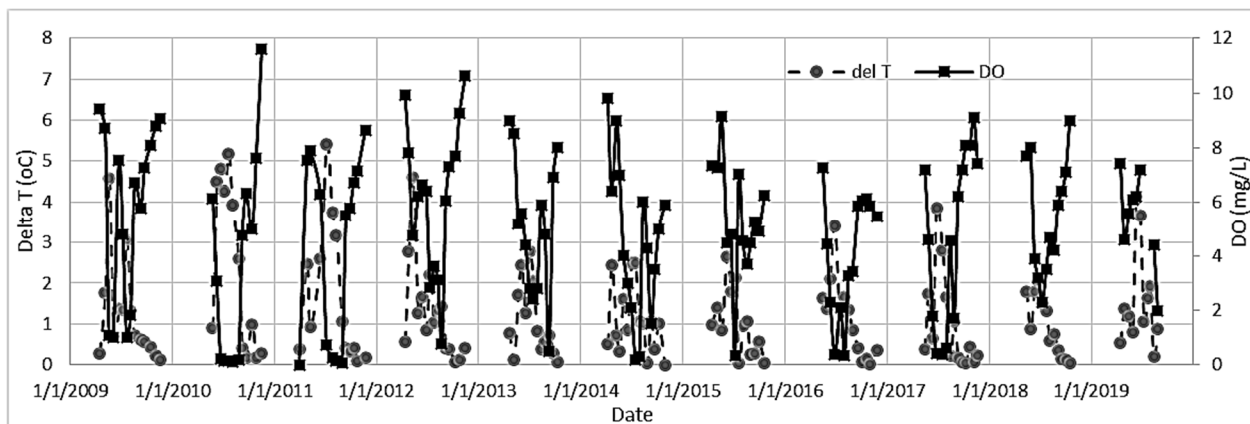

Figure 9. Relationship between bottom water DO concentrations and temperature difference between 1 m and bottom depths (ΔT or del T).

The increases over time in $NH_4\text{-N}$ and $PO_4\text{-P}$ and loss of DO (Figures 7-9) during periods of stratification ($\Delta T > 0.5 - 1^\circ\text{C}$) were used to calculate *in situ* internal recycling and areal hypolimnetic oxygen deficit (AHOD) at TMDL station #1 (Table 7). Included in this table are results from laboratory core-flux measurements in 2002-03 and following alum applications in 2004-06 and 2015 in which intact sediment cores were collected from the lake and incubated in the lab at temperature and DO conditions present at the time of sampling. Good agreement was found between 2002-03 laboratory and 2010-11 *in situ* $PO_4\text{-P}$ flux values, while lower *in situ* values were found for $NH_4\text{-N}$ flux. *In situ* estimates of $PO_4\text{-P}$ flux preceding and following the 2015 alum application were in good agreement with pre- and post-laboratory core-flux incubations. AHOD

Final Report

rates have not previously been measured in the Lake, so *in situ* calculations provide valuable new information about this important process. Moreover, *in situ* AHOD values are consistent with the trophic state of the lake, and were reduced following the 2015 alum treatment. It should also be noted that similar PO₄-P and NH₄-N flux rates were measured in lab core-flux incubations following 2004 and 2015 alum treatments, indicating general reliability of alum treatments to inhibit PO₄-P release.

Table 7. Internal nutrient loading and areal hypolimnetic oxygen demand (AHOD) rates measured in laboratory and estimated from <i>in situ</i> hypolimnetic mass balance approach.					
Parameter	Lab			<i>In Situ</i>	
	2002-03	2004-06 (post-alum)	2015 (post-alum)	2010-11	2015-17 (post-alum)
PO ₄ -P Flux (mg/m ² /d)	13.0 ± 2.8	3.3 ± 2.2	0.7 ± 0.2	15.9 ± 0.1	3.2 ± 1.0
NH ₄ -N Flux (mg/m ² /d)	92.6 ± 19.7	38.7 ± 2.7	40.3 ± 6.3	50.9 ± 10.4	26.0 ± 13.3
AHOD (g/m ² /d)	NA	NA	NA	0.46 ± 0.04	0.31 ± 0.05

Summary

To augment the water quality summaries provided in the TMDL annual reports, additional statistical and advanced machine learning analyses were conducted. Analyses focused on chlorophyll-a as the key response variable. The ratio of total N to total P), often used to identify nutrient limitation, confirm P-limitation principally in place regulating algal production. Correlations developed between total P, total N, TIN and chlorophyll-a for each of the 4 TMDL sampling stations (n=150 for each station) indicate relatively weak correlations with nutrient concentrations, so it is clear that phytoplankton levels are a more complex function of conditions in the lake. Multiple linear regression (MLR) using TN, TP, TIN, TDS and lake level yielded R²-values of 0.31-0.55 depending upon TMDL sampling station.

Since significant portions of variance in observed chlorophyll-a concentrations remained uncaptured using MLR, machine learning was also evaluated. Random forest and gradient-boosted regressor algorithms applied to TMDL station #1 data using day of year, lake level, TDS concentration and windspeed were able to capture most (0.92-0.96) of the observed variance in chlorophyll-a for the 2009-2018 training set, notably without considering concentrations of total N or total P. For comparison, MLR using this same set of independent variables captured 0.43 of variance. The gradient-boosted regressor model also demonstrated strong forecasting power, capturing 0.73 of variance in predicted chlorophyll-a concentrations of the 2019 data set (compared with 0.36 for the equivalent MLR model). Machine learning was thus able to identify relationships and develop regressor models that reproduce and forecast concentrations with considerable accuracy.

Water column profile data were also used to quantify rates of internal nutrient recycling and AHOD. Internal nutrient recycling rates have been measured on a limited number of dates since 2002 using the laboratory core-flux method, while AHOD rates have not previously been measured at the lake. The *in situ* hypolimnetic mass balance approach using measured water

Final Report

column concentrations of ammonium as N ($\text{NH}_4\text{-N}$) and orthophosphate as P ($\text{PO}_4\text{-P}$) yielded recycling rates for 2010-2011 and 2015-2017 that were similar to previously measured values confirming the importance of nutrient recycling in lake biogeochemistry and nutrient budgets, and establishing the reliability of alum treatments in suppressing $\text{PO}_4\text{-P}$ release. The analysis also yielded *in situ* estimates of late spring-early summer AHOD rates at TMDL station #1 of approximately $0.5 \text{ g/m}^2/\text{d}$.

III. DEVELOPMENT OF 2-D HYDRODYNAMIC- WATER QUALITY MODEL FOR BIG BEAR LAKE

Numerical modeling with process-based models is routinely used to simulate historical/baseline and future conditions in lakes and reservoirs. Water quality models represent lake properties and processes through mathematical equations that can vary widely in their complexity, from simple 0-D models such as BATHTUB that involves basic mass balance calculations combined with empirical chlorophyll-a-nutrient responses (Walker, 1987), to highly complex 2-D models such as CE-QUAL-W2 (Wells, 2020) and 3-D hydrodynamic water quality models such as AEM3D (Hodges and Dallimore, 2014; Hipsey, 2014) that solve the Navier-Stokes equation and have highly complex sets of mathematical equations describing ecological interactions and water quality. Nonetheless, even with the most complex models, such models are inherently simplifications of lake ecosystems. The complexity of the model developed and its parameterization is also dependent upon the information available about the lake ecosystem. Big Bear Lake exhibits significant horizontal and vertical gradients in water quality and hydrodynamics, indicating that a 2-D laterally-averaged or 3-D representation of the lake is appropriate. Solution to the Navier-Stokes equation in 3-D is computationally extremely demanding, so 3-D hydrodynamic-water quality models are generally limited to relatively short-term simulation periods, often just months to a few years in duration, making calibration to and simulation of longer time periods often impractical. A 2-D laterally-averaged hydrodynamic-water quality model often provides sufficient resolution to capture longitudinal and vertical gradients in conditions, including local effects of inflows and outflows, while allowing for multi-year calibration of complex biogeochemical processes and simulations of decade-plus time scales.

A 2-D (longitudinal-vertical) hydrodynamic water quality model for Big Bear Lake was developed using CE-QUAL-W2 (Wells, 2018). The model was originally developed at the U.S. Army Corps of Engineers Waterways Experiment Station, extensively refined over time, and has been used for over 450 lakes and reservoirs, nearly 300 rivers, and numerous estuaries and other waterbodies (Wells, 2018). The model quantifies heat and water budgets, 2-D hydrodynamics, and predicts concentrations of nutrients, DO, chlorophyll-a, turbidity, and other parameters. The 2-D (longitudinal-vertical) representation assumes the primary gradients in water column properties and water quality are in the vertical and longitudinal directions, and well-mixed in the lateral direction; model branches can be added for embayments that allow a quasi-3-D representation of the lake. Advantages of CE-QUAL-W2 over the WASP model, which was used in early TMDL work (RWQCB, 2005), include the better spatial representation of the lake, hydrodynamic and water quality models are incorporated into a single model within CE-QUAL-W2, and it allows for multiple algal, macrophyte, and epiphyte species simulating their growth, respiration and mortality, and corresponding influence on nutrient cycling and other processes. CE-QUAL-W2 was recommended to replace the use of WASP in the 2010 TMDL Action Plan (Big Bear Lake TMDL Task Force, 2010).

A. Approach

Development and application of the model requires extensive bathymetric, hydrologic, meteorological, water quality, and other data. The model was developed focusing on the 2009-2019 time period. This period was selected based upon a number of factors, including the wide range of hydrologic and water quality conditions in the lake, and availability of extensive lake monitoring and meteorological data, as well as some watershed monitoring data. The 2-D laterally-averaged model grid was developed from the bathymetric survey data collected by Fugro Pelagos Inc. (2006), including the original dam, which was represented as an internal weir within the model. The model grid included 85 segments with 1 m vertical layers and 5 branches: branch 1, with 58 segments representing the main Lake spanning Stanfield Marsh to the Dam; and branches 2-5 representing Kidd Bay, Boulder Bay, Metcalf Bay and Grout Bay, respectively (Figure 10). Good agreement was in place between model-derived and survey-derived elevation-volume curves, with 0.36% difference in volumes at full pool (Figure 10). The model grid includes Stanfield Marsh, which was not included in original WASP simulation, and allows simulation of supplemental water through the marsh to the main lake.

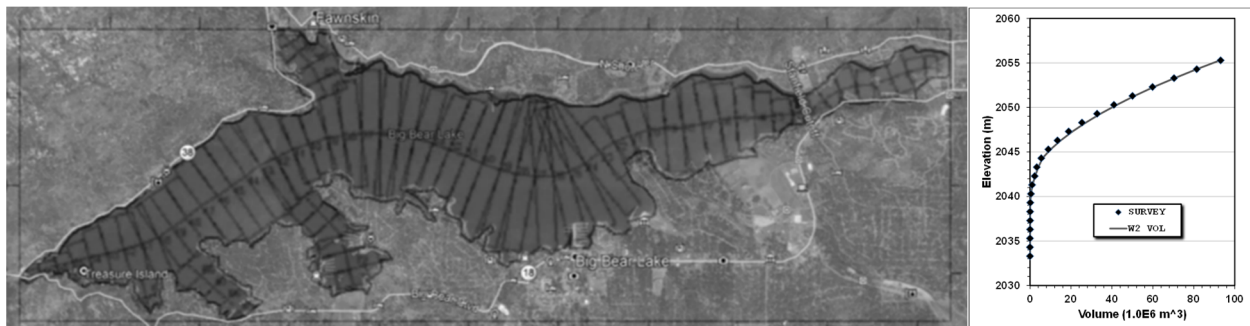

Figure 10. CE-QUAL-W2 model grid developed for Big Bear Lake. Inset depicts agreement between model and measured volume-elevation relationships.

Hydrologic data defining inflows, outflows, and withdrawals were developed from annual Water Master reports. The annual Water Master reports use measured outflows at the dam and water withdrawals by Bear Mountain Ski Resort, evaporative losses estimated using the Blaney Criddle equation, and measured lake surface elevations to derive monthly inflows to the lake. Hourly meteorological conditions were taken from Big Bear Airport and CIMIS Station #199 located at the golf course. Data included solar shortwave radiation (W/m^2), air temperature ($^{\circ}C$), dewpoint temperature ($^{\circ}C$), windspeed (m/s), wind direction ($^{\circ}$) and cloud cover (%). Cloud cover was determined from sky cover conditions reported in METAR data for the airport. The model was calibrated against measured lake level, *in situ* profiles of temperature and dissolved oxygen (DO), and laboratory analyses of water samples collected at the lake.

1. Initial calibration and simulations of lake level, temperature and TDS

The initial model calibration efforts focused on reproducing observed lake levels (water balance) and water column temperatures (heat budget). Surface heat exchange was calculated term-by-term (shortwave, longwave, evaporative, and convective heat flux) with ice cover algorithm and fetch correction active. Vertical eddy viscosity was determined using the turbulent kinetic energy (TKE) formulation, with the Chezy bottom friction solution. Default heat exchange and hydraulic coefficients were generally used in simulations and are summarized in Appendix A.

Evaporation plays a dominant role in both water budget and heat budget calculations. As noted above, the Watermaster uses the Blaney Criddle equation, which is a very simple relationship that uses monthly average temperature and mean daily fraction of annual daylight hours (based on site latitude), to estimate monthly average reference evapotranspiration rate (ET_0) and evaporation rate. In contrast, CE-QUAL-W2 uses local windspeed and the vapor pressure gradient between water surface (based on water surface temperature) and overlying atmosphere (based on air temperature-relative humidity-dewpoint temperature) to determine evaporative heat and water flux on a sub-hourly basis, similar to approaches described in Chapra (2008) and Martin and McCutcheon (1999). The Blaney Criddle equation has been replaced in most applications by more sophisticated models, such as that described above for evaporation from free water surface, or the Penman-Montieth equation for reference ET_0 for estimated water demand for crops. One consequence of the use of a more accurate approach to calculating evaporation from the Lake is that inflows, which were calculated as residuals of water balance equation based upon monthly evaporation from Blaney Criddle equation, were not consistent with the improved evaporative flux rates in CE-QUAL-W2, resulting in over-estimates of water level (not shown). Thus, consistent with the Water Master approach, inflows were calculated from water balance with known lake levels, volumes and losses (with improved evaporative losses) using the CE-QUAL-W2 water balance utility. Also, as noted, the Blaney Criddle equation calculates monthly average evaporative loss, so the Water Master reports present monthly average inflows. Since weekly water surface elevation data was available, the water balance utility was able to provide finer resolution to the computed inflow data (Figure 11a). Outflow and seasonal withdrawals by the ski resort were used as reported in the Water Master Reports (Figure 11b). The severe storms and runoff generated in early 2011 represented the only substantial outflows from the lake beyond the in-stream flow requirements for Bear Creek downstream of the dam (Figure 11b). For initial water balance and TDS simulations, the distributed tributary approach was used. Allocations for specific creek discharges were used in water quality simulations and are described in more detail below.

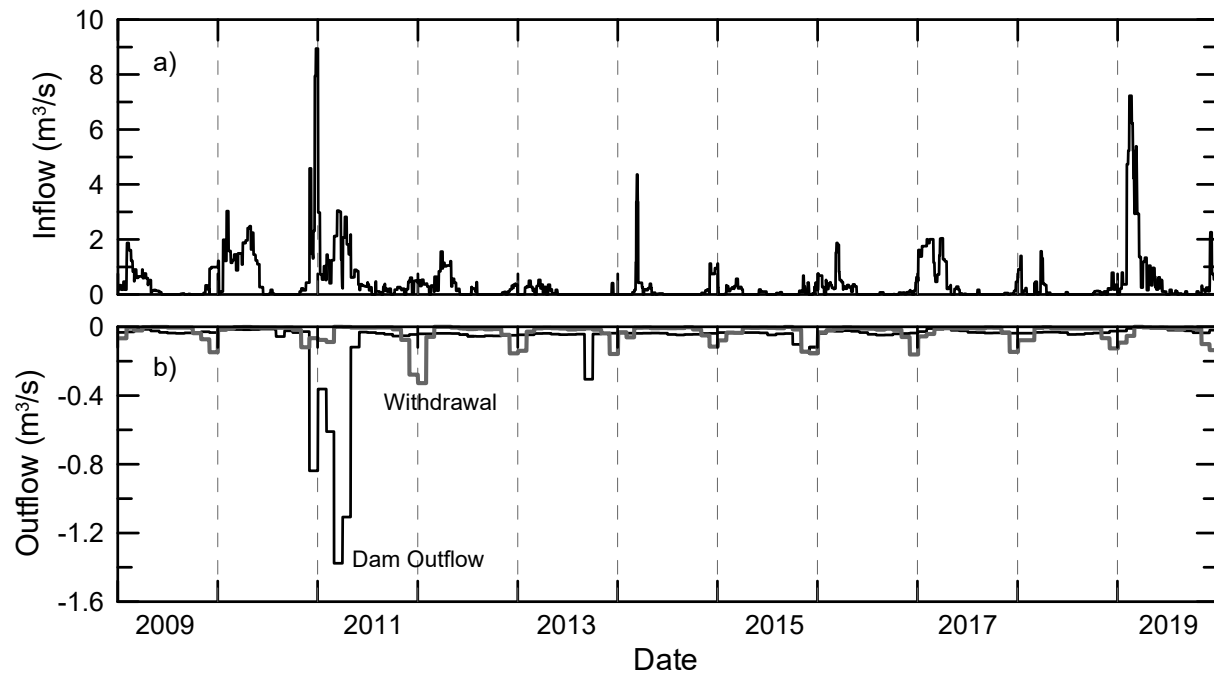

Figure 11. Hydrologic temporal boundary conditions for model calibration (2009-2019): a) total inflow and b) outflows due to withdrawals and dam outflow (from Water Master reports).

The outcome of the water balance calculations was an accurate prediction of lake level over the 2009-2019 calibration period (Figure 12). With the fitting of inflows, mean absolute error (MAE) between predicted and observed lake surface elevation was 3.6 cm.

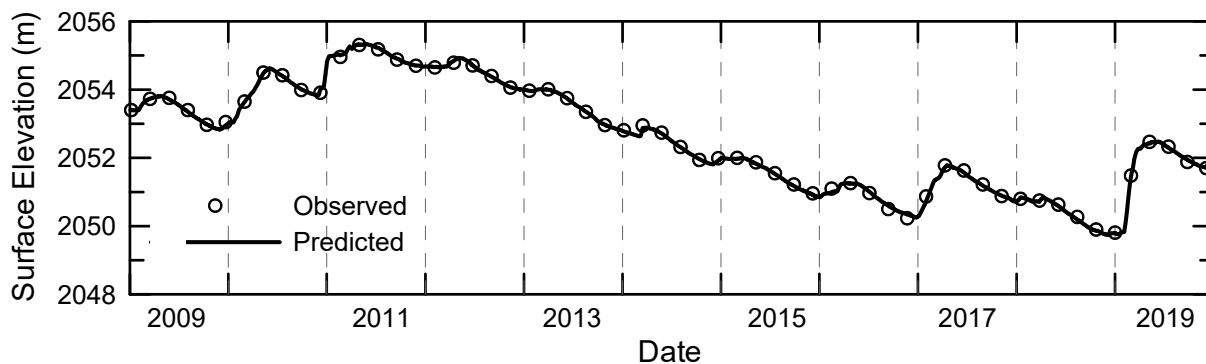

Figure 12. Predicted and observed water surface elevations.

Agreement between predicted and observed water levels is only partial confirmation of the suitability of the model for predicting water balance, since heat flux associated with evaporation is also a key component of the heat budget of lakes (Martin and McCutcheon, 1999). That is, water budgets and heat budgets are explicitly linked through the specific heat of vaporization of water. This is especially important for Big Bear Lake, where evaporation represents the principal mechanism for water loss from the lake (Santa Ana Water Board, 2005). The model quite

Final Report

accurately reproduced temperature profiles in the lake (Figure 13). (Additional profile calibration figures are provided in Appendix B.)

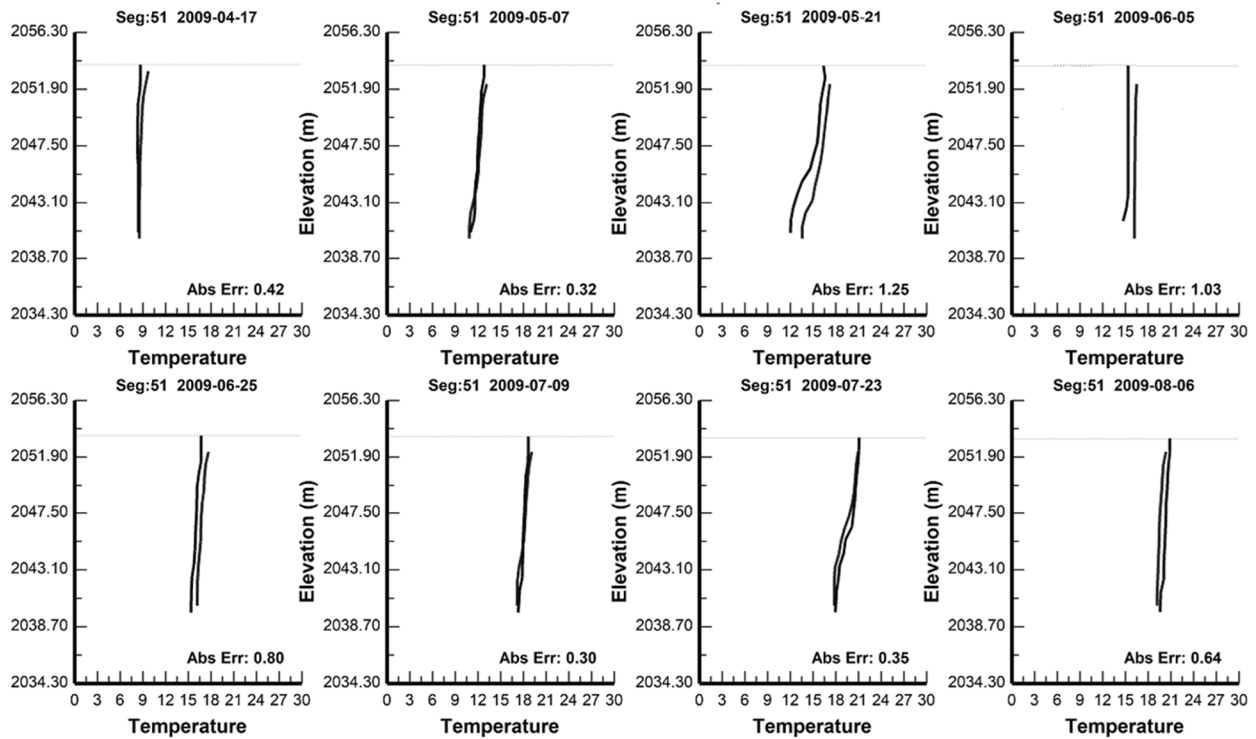

Figure 13. Model predicted and observed water column temperature profiles at station #1 (April 17 – August 6, 2009).

Mean absolute error (MAE) for temperature for profiles collected at the four TMDL sampling stations ranged from 0.95 – 1.14 °C (145 profiles, with 858-1974 discrete temperature measurements depending upon station) (Table 8).

Table 8. Mean absolute error for model predictions of water column temperatures at the four TMDL sampling stations (145 profiles; 858-1974 discrete measurements in each profile).				
	#1 (Dam)	#2 (Gilner Pt)	#6 (Mid-lake)	#9 (Stanfield)
MAE (°C)	1.14	0.99	0.95	1.02

TDS concentrations were also simulated in the preliminary phase of model development and calibration. TDS concentration (g/L) was calculated from *in situ* specific conductance (mS/cm) in profile measurements with a proportionality constant of 0.65. Information about TDS (conductivity) of inflowing water was available only for very limited points in time, generally under low-moderate flow conditions. It was thus not feasible to develop comprehensive discharge-TDS relationships from available data. As an alternative, a general form of the discharge-TDS relation (inverse power law) developed from USGS gage #10260500 at Deep Creek was fitted to the Big Bear watershed of the form:

$$TDS \text{ (mg/L)} = 36 * Q \text{ (m}^3\text{/s)}^{-0.26} \quad (1)$$

where Q represents the total flow to the lake derived from water budget calculations described previously. The relationship yielded a MAE of 13.3 mg/L (relative error of 15.4%) when applied to Metcalf and Summit Creek data.

Application of the TDS-flow equation to lake inflows, and simulation with CE-QUAL-W2 captured main features and trends in measured lake TDS (from conductivity) for 2009-19 (Figure 14). The MAE between predicted and observed lake TDS concentrations was 11.9 mg/L (4.8% relative error).

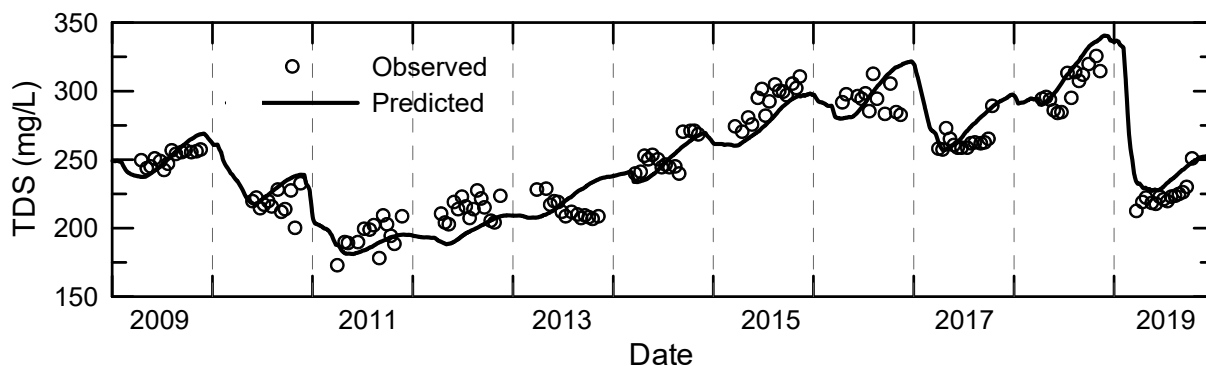

Figure 14. Predicted and observed TDS concentrations.

With the model reasonably representing lake level, water column temperature and TDS concentrations over the wide range of conditions present during 2009-2019, attention was then turned to water quality, focusing on nutrient and chlorophyll-a concentrations.

2. Calibration to Water Quality Data for Big Bear Lake

Lakes are recognized as complex ecosystems influenced by complicated physical, chemical, and biological properties, processes, and inter-relationships. Through the well-designed and high quality lake monitoring program conducted in support of the TMDL at Big Bear Lake, an excellent record of water column conditions and water quality is available with which to calibrate the CE-QUAL-W2 model. Watershed sampling has also been incorporated into the monitoring program, thus providing more extensive empirical information about nutrient and sediment contributions to the lake that were not available in earlier work, which chiefly relied on HSPF simulations of watershed runoff and loading to the lake.

As thoroughly described in the TMDL staff report, loading of nutrients to Big Bear Lake is from (i) external loading from point and nonpoint sources within the watershed, (ii) atmospheric deposition, (ii) internal recycling from bottom sediments, and (iv) macrophyte growth, senescence and death (Santa Ana Water Board, 2005). These processes were integral to the development and application of the CE-QUAL-W2 model for the lake, and are discussed in some detail below.

(i) External loading from the watershed

External loading (EL) (kg/d) from the watershed is the product of inflow rate Q_i (m^3/d) and influent concentrations C_i (kg/m^3) for each source i :

$$EL = \sum_{i=1}^n Q_i C_i \tag{2}$$

Runoff rates from specific source areas were derived in previous modeling from HSPF simulations (Figure 15) and linked to WASP model segmentation, which excluded Stanfield Marsh (Figure 16) (Tetra Tech, 2004).

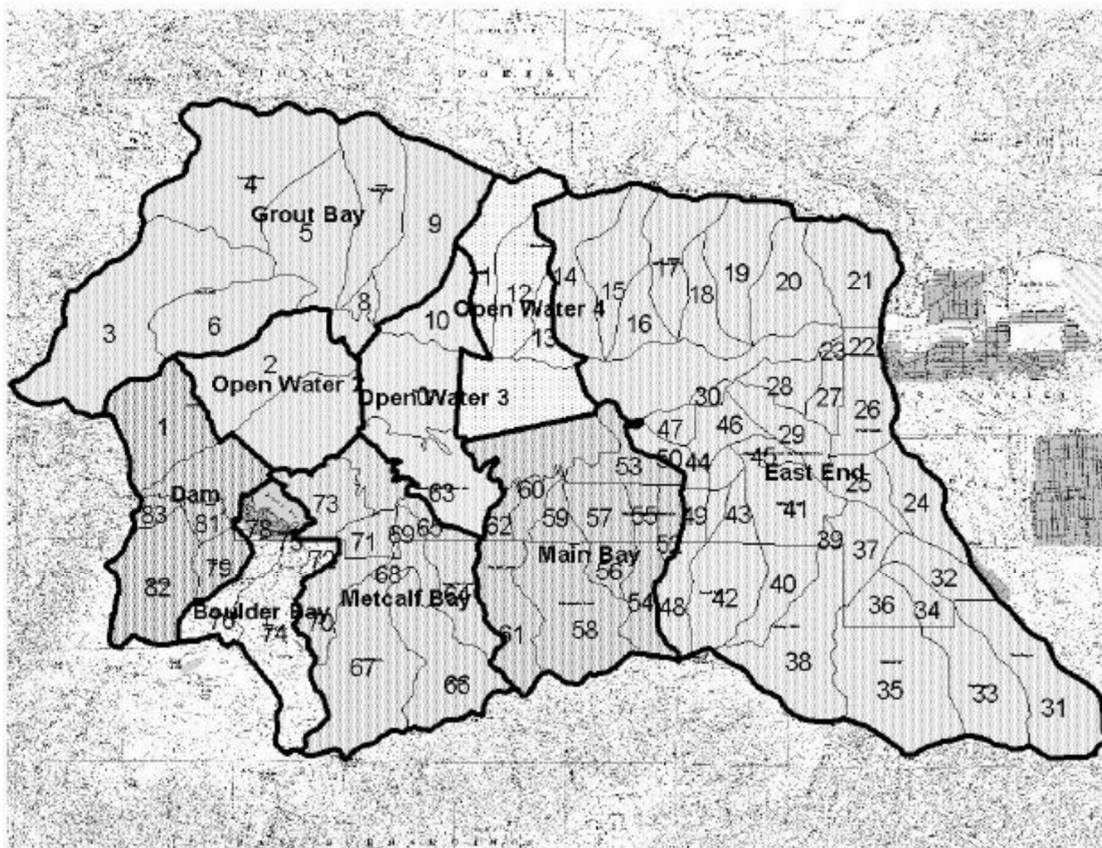

Figure 15. Contributing watershed areas to WASP segments developed from HSPF watershed model (Tetra Tech, 2004).

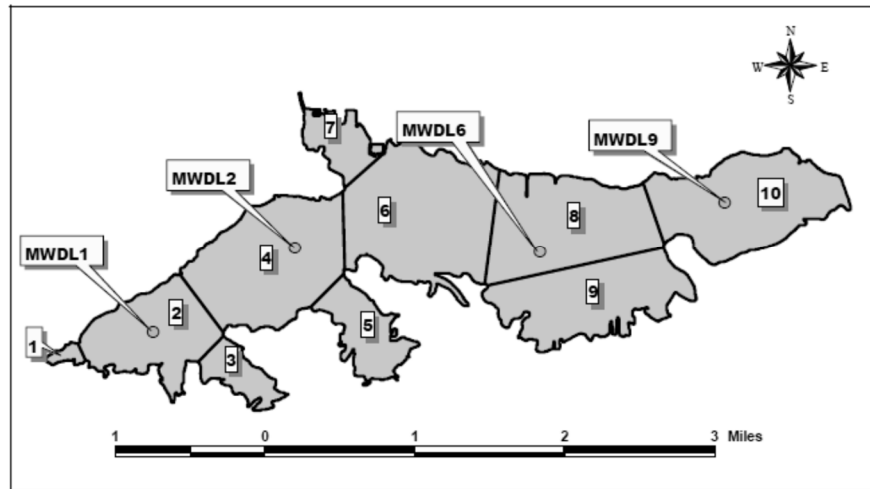

Figure 16. Model segmentation in previous WASP model simulations (Tetra Tech, 2004).

Total inflows, derived from water balance calculations described above, were allocated to regions of the lake following the approach used in the original WASP model. Total inflows (Figure 11a) were allocated to Boulder Bay, Metcalf Bay, Grout Bay and Rathbun Creek (Figure 17), based upon median % flows from prior HSPF simulation results. One difference with the earlier HSPF-WASP model approach is that the WASP model included flows to WASP segment 9 (Figure 16) as a distinct input; the coarse level segmentation in WASP does not map onto the 2-D laterally averaged grid of the CE-QUAL-W2 model, so distributed flow was used to represent both flows to segment 9 and from additional non-point sources (e.g., WASP segments 8 and 4 on the north side of the lake) (Figure 17). Distributed and Rathbun Creek flows in the CE-QUAL-W2 model collectively comprised over 65% of the total inflows to the lake.

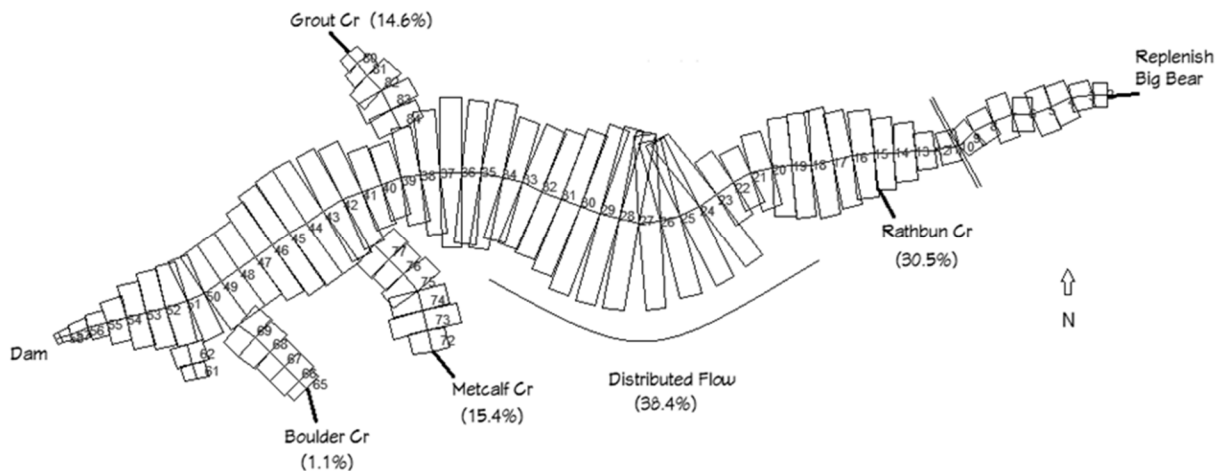

Figure 17. CE-QUAL-W2 model segmentation showing branch, tributary and distributed inflows.

Concentrations of nutrients within these different inflows over time were determined from available watershed monitoring data, rather than HSPF simulations as done in the initial WASP

Final Report

model (More recent HSPF simulations have apparently been conducted, but results were unavailable.) Median concentrations based upon available data are provided in Table 9, while concentration ranges are presented in Table 10. A very limited set of measurements were identified for Boulder Creek and Grout Creek based on sampling in 2010-2011 (n=7 and 12, respectively). More extensive sampling was conducted for Knickerbocker, Rathbun, and Summit Creeks over 2010-2011 and 2016-2019 (n=53, 28 and 27, respectively). Although complete laboratory analyses on all samples were not always available. For example, laboratory measurements of total Kjeldahl N (TKN), dissolved Kjeldahl N (DKN), total organic carbon (TOC) and dissolved organic carbon (DOC) were only available for samples collected since 2016.

Creek	TP	o-P	TN	TKN	DKN	NH ₄ -N	NO ₃ -N	TOC	DOC
Boulder (n=7)	0.009	0.007	0.184	-	-	0.011	0.022	-	-
Grout (n=12)	0.024	0.015	0.282	-	-	0.008	0.121	-	-
Knickerbocker(n=53)	0.055	0.038	0.374	0.34	0.22	0.130	0.130	2.9	2.7
Rathbun (n=28)	0.055	0.038	0.786	0.46	0.36	0.419	0.419	5.1	4.9
Summit (n=27)	0.069	0.021	0.530	0.52	0.25	0.180	0.180	6.0	3.6

Concentrations of total and dissolved forms of N and P varied widely, often by an order of magnitude or more, within the sampling conducted at the creeks (Table 8).

Creek	TP	o-PO ₄ -P	TN	NH ₄ -N	NO ₃ -N
Boulder	0.005 - 0.017	0.005 - 0.009	0.130 - 1.103	0.007 - 0.040	0.002 - 0.042
Grout	0.010 - 0.037	0.010 - 0.026	0.083 - 1.263	0.005 - 0.057	0.011 - 1.054
Knickerbocker	0.020 - 0.320	0.010 - 0.160	0.142 - 1.770	0.005 - 0.290	0.021 - 1.200
Rathbun	0.020 - 0.180	0.010 - 0.100	0.270 - 1.890	0.008 - 0.300	0.005 - 1.190
Summit	0.020 - 0.378	0.003 - 0.155	0.023 - 1.300	0.007 - 0.220	0.003 - 0.602

Creek	TKN	DKN	TOC	DOC
Knickerbocker	0.12 - 1.20	0.012 - 0.67	1.3 - 12.0	1.4 - 8.8
Rathbun	0.077 - 1.40	0.21 - 0.77	2.9 - 7.7	2.6 - 7.1
Summit	0.10 - 0.95	0.00 - 0.78	2.8 - 7.5	2.2 - 7.0

Water quality in runoff can vary strongly depending upon characteristics of the basin, including land use, land cover, amount of impervious surfaces and other factors, and are reflected in the higher concentrations of nutrients in Knickerbocker, Rathbun, and Summit Creeks compared with Boulder and Grout Creeks (Tables 9, 10). The nature and intensity of storms (rain, snow, rain-on-snow), meteorological, and antecedent watershed conditions influence discharge and also influence water quality, contributing to the wide range in concentrations observed at the creeks (Table 10). Since a very limited number of point estimates of flow were available, it was not feasible to develop reach-specific discharge-water quality relationships, but total flows to the lake were known from water balance considerations. Measured nutrient concentration were statistically evaluated for possible correlations with total flow rates (Table 11). Sample sizes varied by creek, with only 7 and 12 samples collected from Boulder Creek and Grout Creek, respectively, while Knickerbocker, Rathbun, and Summit Creeks were sampled 53, 28 and 27

Final Report

times, respectively. Weak correlations with total flow were observed for most variables, although total flow accounted for a meaningful fraction of the total variance in NO₃-N concentrations (up to R-value of 0.62, or R² of 0.38, representing 38% of observed variance in NO₃-N concentration for Rathbun Creek). Nonetheless, regressions even for NO₃-N had modest predictive power (Table 11, Figure 18). Assumptions about inflows and influent concentrations were necessitated by the limited amount of data and thus represent a significant source of uncertainty in model predictions.

Creek	TP	o-P	TN	TKN	DKN	NH ₄ -N	NO ₃ -N	TOC	DOC
Boulder	0.41	0.31	-0.13	-	-	0.29	-	-	-
Grout	0.52	0.61	0.52	-	-	0.42	0.48	-	-
Knickerbocker	0.00	0.06	-0.03	0.01	0.00	-0.14	0.19	0.13	0.34
Rathbun	-0.21	-0.20	0.28	0.04	0.38	-0.12	0.62	0.43	0.53
Summit	-0.05	0.04	0.08	0.21	0.66	-0.02	0.52	0.18	0.38

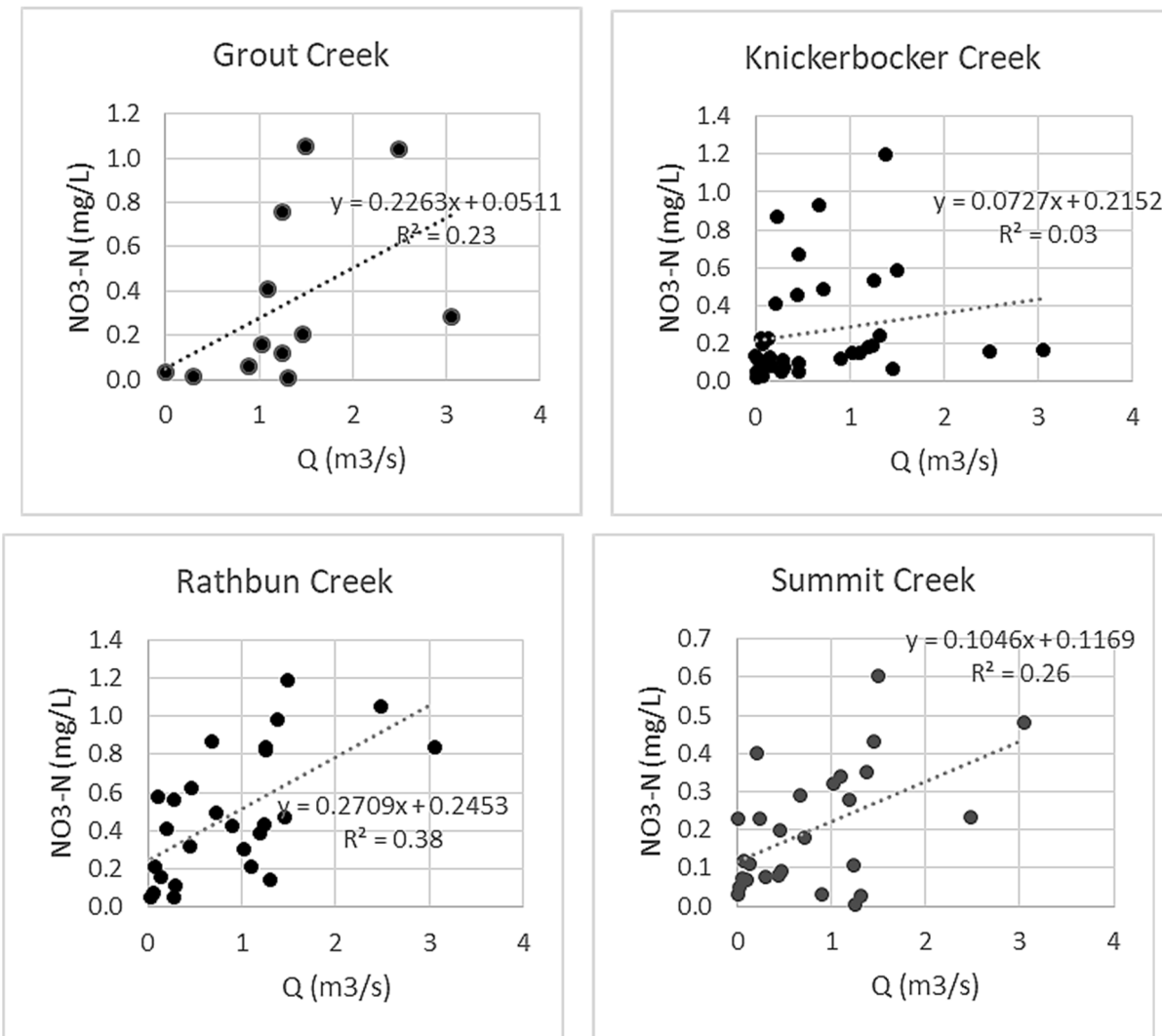

Figure 18. Plots and regression lines between NO₃-N concentrations and total (lakewide) flow for a) Grout Creek, b) Knickerbocker Creek, c) Rathbun Creek, and d) Summit Creek.

Measured nitrogen and phosphorus concentrations were used when available and assumed to represent influent concentrations for the entire month in which the measurements were made; for time periods when measured values were not available, median values were used, except as follows: NO₃-N (all creeks except Boulder) and PO₄-P (Grout and Knickerbocker only), when concentrations were estimated from regressions with total flow for that date. The incorporation of measured, median, and regression-based influent concentrations into model input time-series is illustrated for Rathbun Creek (Figure 19).

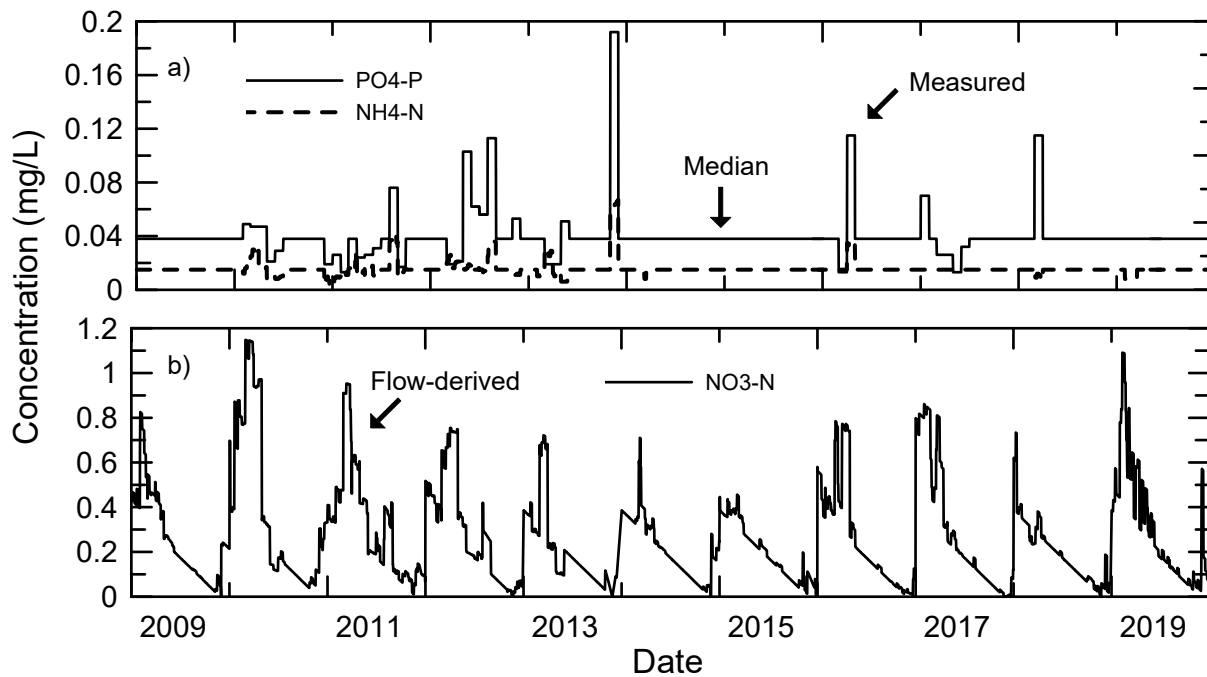

Figure 19. Modeled input nutrient concentrations in Rathbun Creek: a) PO₄-P and NH₄-N illustrating use of measured values when available and median values when not, and b) NO₃-N concentrations derived from regression with total flow rate.

Particulate forms of N, P, and C were calculated by difference between total and dissolved forms. Following White et al. (2010) and Wetzel (1984), organic matter was further partitioned into labile and refractory forms (approximately 25 and 75%, respectively).

(ii) Atmospheric deposition

In addition to external loading from the watershed, atmospheric deposition is also an important source of N and P to Big Bear Lake. Based upon available studies by Mark Fenn and others in the San Bernardino Mountains, direct deposition of N onto the lake (assumed for modeling purposes to be equimolar NH₄ and NO₃) was estimated to be approximately 10 kg/ha/yr, while direct deposition of total P was assumed to be 1/20th that of N, or 0.5 kg/ha/yr (Santa Ana Water Board, 2005). The CE-QUAL-W2 model does not simulate transformations and release of P bound to inorganic particles, so it was assumed that 40% of the total P (chiefly as fine inorganic dust particles) was in a bioavailable form and deposited as PO₄-P.

(iii) Internal recycling from bottom sediments

Release from bottom sediments through mineralization of organic matter and reductive dissolution of ferric oxyhydroxides was simulated in CE-QUAL-W2 using the dynamic 1st-order sediment decay model combined with the 0-order SOD model. The 1st-order sediment model uses a sediment compartment to accumulate organic sediments as a result of settling of algae and particulate organic matter, and allow their decay, releasing NH₄-N and PO₄-P back to the water column (Figure 20).

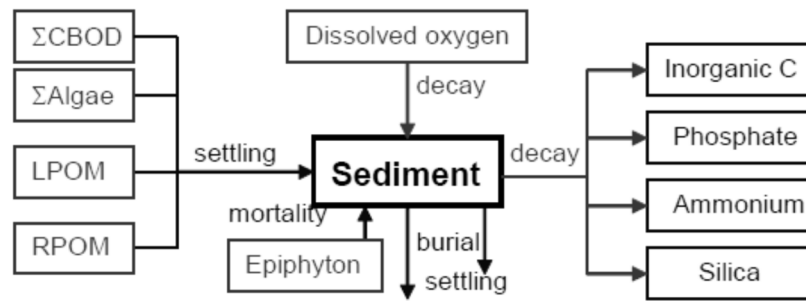

Figure 20. Schematic of 1st-order sediment subroutine in CE-QUAL-W2.

As a 1st-order process, the greater the amount of organic matter settling to the sediment compartment results in greater amounts of organic matter decayed, and N and P mineralized and released back to water column (i.e., recycled). Simulation values are provided in Table 12.

Table 12. 1st-order sediment model parameter values used in simulations. Default W2 values from Wells (2019).

Parameter	Default	Value	Description
SEDCI	0	4.4	Initial reactive sediment concentration (g/m ³)
SEDS	0.1	0.08	Sediment settling rate (m/d)
SEDK	0.1	0.1	Sediment decay rate (d ⁻¹)
FSOD	1	0.23	Fraction of 0-order SOD rate used
FSED	1	1	Fraction of 1 st -order sediment concentration used
SEDBR	0.01	0.01	Sediment burial rate (d ⁻¹)

The 1st-order model simulates aerobic decomposition reactions, so sediment oxygen demand is also dynamically calculated based upon amount and type of organic matter and temperature, and depletion of DO in turn reduces rates of organic matter mineralization and deamination-dephosphorylation reactions. The 1st-order sediment model thus doesn't simulate nutrient release under anaerobic conditions, although, anaerobic decomposition and reductive dissolution reactions can be important processes within nutrient cycling. As a result, the 0-order SOD model (Figure 21) was used to simulate N and P nutrient release during anaerobic conditions. Maximum values for SOD were varied from 0.1 for shallow low organic matter sediments to 1.0 g/m²/d at TMDL station #1 and 1.2 g/m²/d for deepest high organic sediments adjacent to the dam; rates were assumed to vary linearly with temperature between 4 and 30°C, corresponding to a maximum summer 0-order SOD rate of about 0.6 g/m²/d at TMDL station #1.

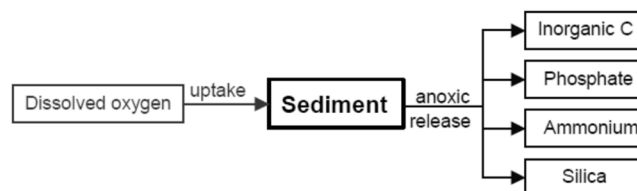

Figure 21. Schematic of 0th-order sediment oxygen demand subroutine in CE-QUAL-W2.

(iv) Macrophyte growth, senescence, and death

Macrophytes are an important component of Big Bear Lake’s ecosystem, providing habitat for fish, zooplankton, larval aquatic insects, a variety of benthic animals, and epiphytic periphyton. Aquatic vegetation surveys have periodically been conducted, with coontail, common waterweed, and Eurasian watermilfoil often comprising much of the total macrophyte biomass. Macrophyte growth, senescence, and death are also important features of the nutrient cycle of the lake. Harvesting and herbicide applications have helped control macrophyte growth, with harvesting also serving as strategy to export nutrients from the lake. CE-QUAL-W2 includes macrophyte subroutines that simulate plant life cycles and their effect on hydrodynamics, nutrients, light, and other factors.

Since detailed information about the species composition, density, and distribution of macrophytes over the 2009-2019 timeframe was not available, a composite macrophyte group was incorporated into the model. CE-QUAL-W2 modeling conducted by the USGS (2013) for the Klamath River upstream of Keno Dam, Oregon served as the basis for macrophyte submodel parameterization (Table 13). The composite macrophyte extracted nutrients from the water column, as coontail and to a slightly lesser extent milfoil do, and from bottom sediments, as typical rooted aquatic vascular plants do.

Table 13. Macrophyte model parameter values used in simulations.			
Parameter	USGS ^a	Value	Description
MG	0.34	0.3	Maximum macrophyte growth rate (d ⁻¹)
MR	0.09	0.09	Maximum macrophyte respiration rate (d ⁻¹)
MM	0.06	0.06	Maximum macrophyte mortality rate (d ⁻¹)
MSAT	5	10	Light saturation intensity at max photosynthesis rate (W/m ²)
MPOM	0.7	0.7	Fraction of macrophyte biomass converted to POM upon death
LRPMAC	0.2	0.2	Fraction of POM that becomes labile POM
PSED	0.4	0.27	Fraction of P uptake from sediments
NSED	0.4	0.27	Fraction of N uptake from sediments
MBMP	40	40	Threshold concentration when growth to next layer (g/m ³)
MMAX	108	1000	Maximum macrophyte concentration (g/m ³) (W2 default = 500 g/m ³)
CDDRAG	0	1	Macrophyte drag coefficient
MT1	14	14	Lower temperature for rising growth rate function (°C)
MT2	24	24	Upper temperature for rising growth rate function (°C)
MP	0.004	0.005	Stoichiometric ratio between P and biomass (g/g)
MN	0.054	0.05	Stoichiometric ratio between N and biomass (g/g)
MC	0.51	0.5	Stoichiometric ratio between C and biomass (g/g)

^acomposite macrophyte based on average of values for Coontail and Common Waterweed. USGS (2013).

v. Epiphyton dynamics

A vast majority of algal species can colonize surfaces, including macrophytes, and can approach or exceed primary production of macrophytes (e.g., Jones, 1984). Given the relatively shallow depths in the embayments and eastern end of the lake and relatively high water clarity much of the year, epiphyton were also included in the model. Epiphyton are subject to the same

environmental factors and processes as phytoplankton with the exception of settling loss from the water column (Table 14).

Table 14. Epiphyton model parameter values used in simulations. Default W2 values from Wells (2019).

Parameter	Default	Value	Description
EG	2	2	Maximum epiphyton growth rate (d ⁻¹)
ER	0.04	0.045	Maximum epiphyton respiration rate (d ⁻¹)
EE	0.04	0.045	Maximum epiphyton excretion rate (d ⁻¹)
EM	0.1	0.1	Maximum epiphyton mortality rate (d ⁻¹)
EB	0.001	0.001	Epiphyton burial rate (d ⁻¹)
EHSP	0.003	0.003	Epiphyton half-saturation for P-limited growth (g/m ³)
EHSN	0.014	0.014	Epiphyton half-saturation for N-limited growth (g/m ³)
EHSSI	0	0	Epiphyton half-saturation for Si-limited growth (g/m ³)
ESAT	75	75	Light saturation intensity at max photosynthesis rate (W/m ²)
EHS	35	82	Biomass limitation factor (g/m ²)
ENEQN	2	2	Ammonia preference factor equation (1 or 2)
ENPR	0.001	0.001	N-half saturation preference constant (g/m ³)
EP	0.005	0.003	Stoichiometric ratio between P and biomass (g/g)
EN	0.08	0.082	Stoichiometric ratio between N and biomass (g/g)
EC	0.45	0.45	Stoichiometric ratio between C and biomass (g/g)

vi. Phytoplankton dynamics

With information about external nutrient loading from the watershed, atmospheric deposition, internal nutrient recycling, and role of macrophytes and epiphyton, attention was then turned to parameterization of the model to reproduce seasonal and interannual phytoplankton dynamics as expressed through trends in chlorophyll-a. Algal levels are governed by the availability of nutrients and light, and regulated by a complex set of processes, including respiration, settling, grazing, and mortality (Figure 22):

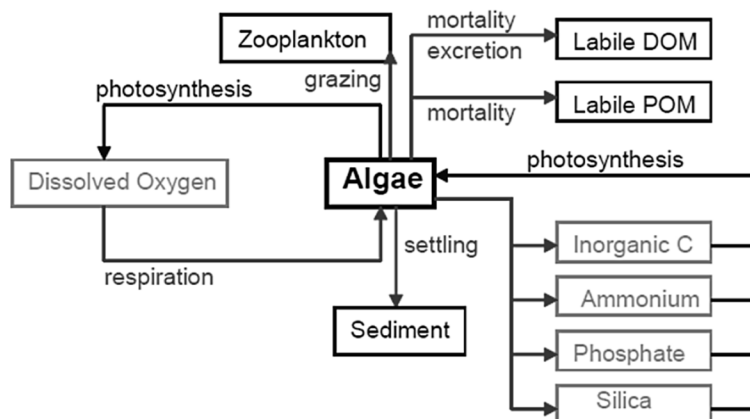

Figure 22. Schematic of phytoplankton subroutine in CE-QUAL-W2.

No specific genus or species was simulated and parameter values at or near CE-QUAL-W2 default values were used (Table 15). Two phytoplankton groups were simulated, with algal group #2 capable of N₂-fixation.

Table 15. Phytoplankton model parameter values used in simulations. Default W2 values from Wells (2019).

Parameter	Default	Algae 1	Algae 2	Description
AG	2	2	1.7	Maximum algal growth rate (d ⁻¹)
AR	0.04	0.04	0.05	Maximum algal respiration rate (d ⁻¹)
AE	0.04	0.04	0.05	Maximum algal excretion rate (d ⁻¹)
AM	0.1	0.1	0.1	Maximum algal mortality rate (d ⁻¹)
AS	0.1	0.1	0.1	Algal settling rate (d ⁻¹)
AHSP	0.003	0.003	0.005	Algal half-saturation for P-limited growth (g/m ³)
AHSN	0.014	0.03	0	Algal half-saturation for N-limited growth (g/m ³)
AHSSI	0	0	0	Algal half-saturation for Si-limited growth (g/m ³)
ASAT	100	90	100	Light saturation intensity at max photosynthesis (W/m ²)
ALPOM	0.8	0.8	0.8	Fraction of algae lost by mortality to POM
ANEQN	2	1	1	Ammonia preference factor equation (1 or 2)
ANPR	0.001	0.001	0.001	N-half saturation preference constant (g/m ³)
AP	0.005	0.003	0.0031	Stoichiometric ratio between P and biomass (g/g)
AN	0.08	0.09	0.09	Stoichiometric ratio between N and biomass (g/g)
AEC	0.45	0.45	0.45	Stoichiometric ratio between C and biomass (g/g)

3. Model Calibration Results

As previously noted, water quality in Big Bear Lake varied widely over 2009-2019 (Table 1). The model reproduced seasonal and inter-annual variations in chlorophyll-a concentrations reasonably well, including increased concentrations in the latter half of the 2009-2019 study period associated with lower lake levels (Figure 23).

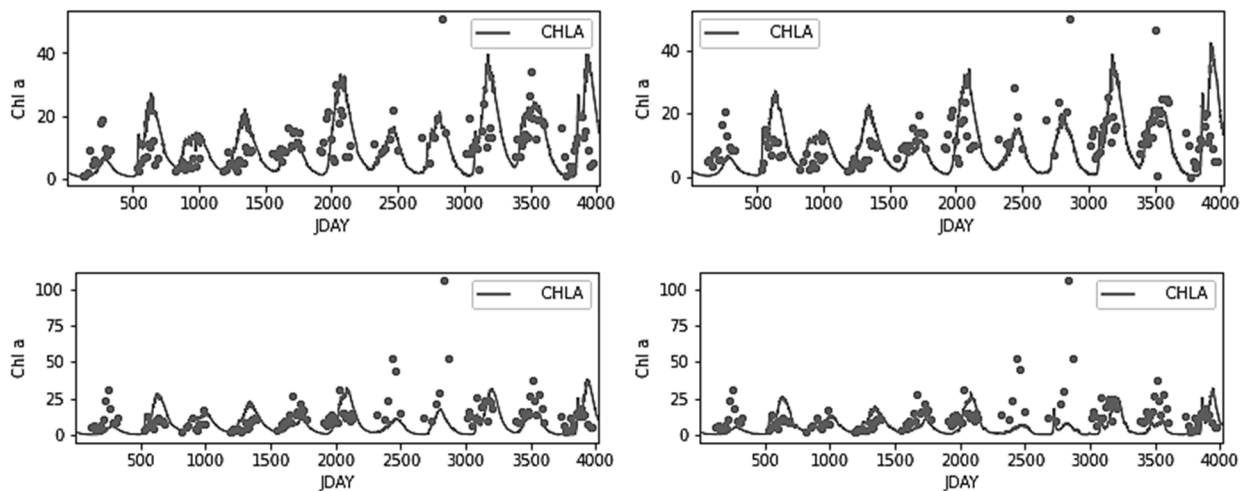

Final Report

Figure 23. Predicted (line) and observed (circles) chlorophyll-a concentrations ($\mu\text{g/L}$) over 2009-2019 calibration period for TMDL sampling stations: a) #1 (dam), b) #2 (Gilner Point), c) #6 (Mid-lake), and d) #9 (Stanfield). JDAY represents simulation day (elapsed Julian day) since 1/1/2009.

The model also reproduced central tendencies present in measured TP concentrations, including seasonal variations and trends of increased concentrations in the latter half of the 2009-2019 study period, but predicted seasonal variations that were dampened relative to reported data (Figure 24). In particular, the model over-predicted total P around day 2300-2600 which corresponds to the alum application in 2015. CE-QUAL-W2 doesn't have subroutines specifically simulating an alum application, and after some effort, it was deemed not readily feasible to accurately simulate the flocculation, sorption, and settling of alum and sorbed P and N within CE-QUAL-W2. Some limitations to the macrophyte submodel were also identified (Appendix C).

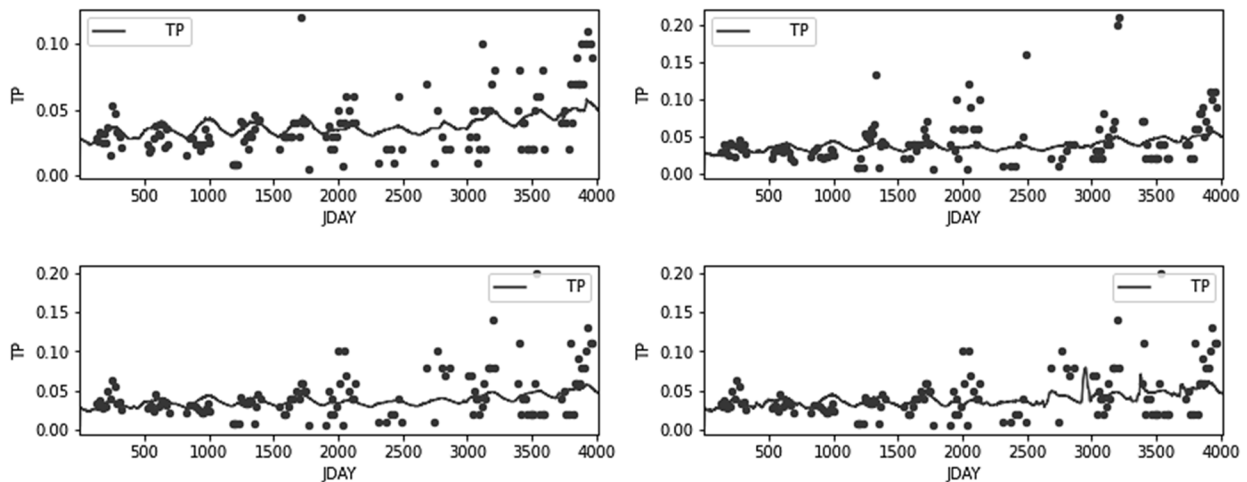
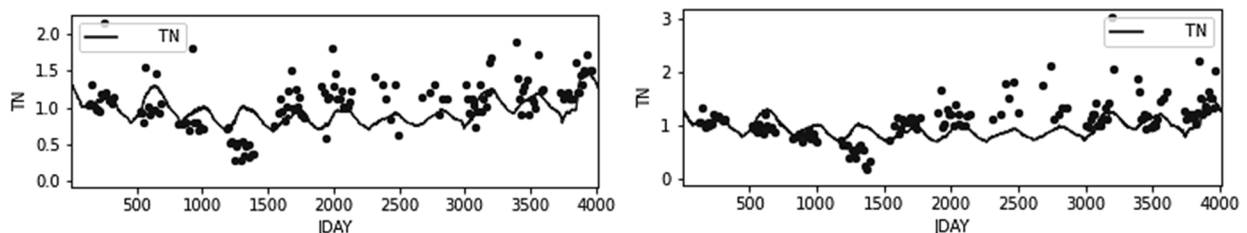

Figure 24. Predicted (line) and observed (circles) total P (TP) concentrations (mg/L) over 2009-2019 calibration period for TMDL sampling stations: a) #1 (dam), b) #2 (Gilner Point), c) #6 (Mid-lake) and d) #9 (Stanfield). JDAY represents simulation day (elapsed Julian day) since 1/1/2009.

The predicted amount of N might be expected to increase N concentrations somewhat, as further P-limitation would restrict amount of N also incorporated into algal biomass.



Final Report

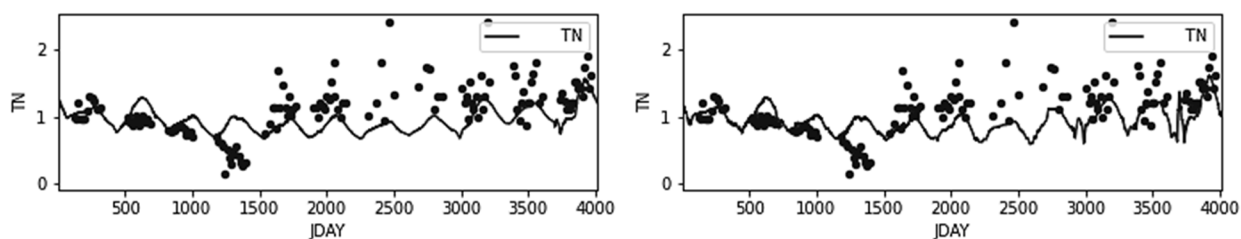

Figure 25. Predicted (line) and observed (circles) total N (TN) concentrations (mg/L) over 2009-2019 calibration period for TMDL sampling stations: a) #1 (dam), b) #2 (Gilner Point), c) #6 (Mid-lake) and d) #9 (Stanfield). JDAY represents simulation day (elapsed Julian day) since 1/1/2009.

As evident in Figures 23-25, very wide swings in reported total nutrient and chlorophyll-a concentrations were sometimes present, with sample concentrations occasionally up to 3-5 times higher than samples collected immediately prior to or immediately thereafter (e.g., Figure 24, TP concentration of 0.12 mg/L around day 1700 for TMDL station #1). While analytical error is present in all measured values, a Grubbs outlier test was used to identify outliers at $p < 0.01$ prior to calculation of model error statistics. A total of 7/424 outliers were statistically identified for chlorophyll-a, 5/600 for total P, 2/600 for total N and 6/600 for total inorganic N. Outliers removed due to analytical, sample handling, or other errors thus constituted only 0.33-1.6% of total reported values. Even with removal of outliers at $p < 0.01$, it nonetheless bears noting that model calibration errors have field and laboratory errors imbedded within them, as well as from other factors (Harmel et al., 2006). Model error statistics, including mean error, mean absolute error, and root mean square error, are summarized in Table 16.

Property	N	Range	ME	MAE	RMSE	RRMSE (%) ^a
Chlorophyll-a ($\mu\text{g/L}$)	417	0.5 – 43.2	-1.3	7.9	10.3	24.0
Total P (mg/l)	595	0.005 - 0.180	-0.010	0.022	0.031	17.7
Total N (mg/L)	598	0.126 - 2.415	-0.148	0.310	0.413	18.0
Total Inorganic N (mg/L)	594	0.007 - 0.319	-0.049	0.050	0.092	29.5

^a=(RMSE/Range)*100

Dissolved oxygen concentrations are influenced by, and also often regulate, the biogeochemical processes operating in the lake. It was previously shown that the model adequately reproduced water column temperatures (Figure 13, Table 8); the model was also generally successful in reproducing measured DO concentrations (e.g., Figure 26, Table 17). (Additional profiles provided in Appendix D). While the lake was often relatively well-mixed vertically, low DO concentrations above the sediments were frequently present as a result of aerobic decomposition and respiration reactions.

Final Report

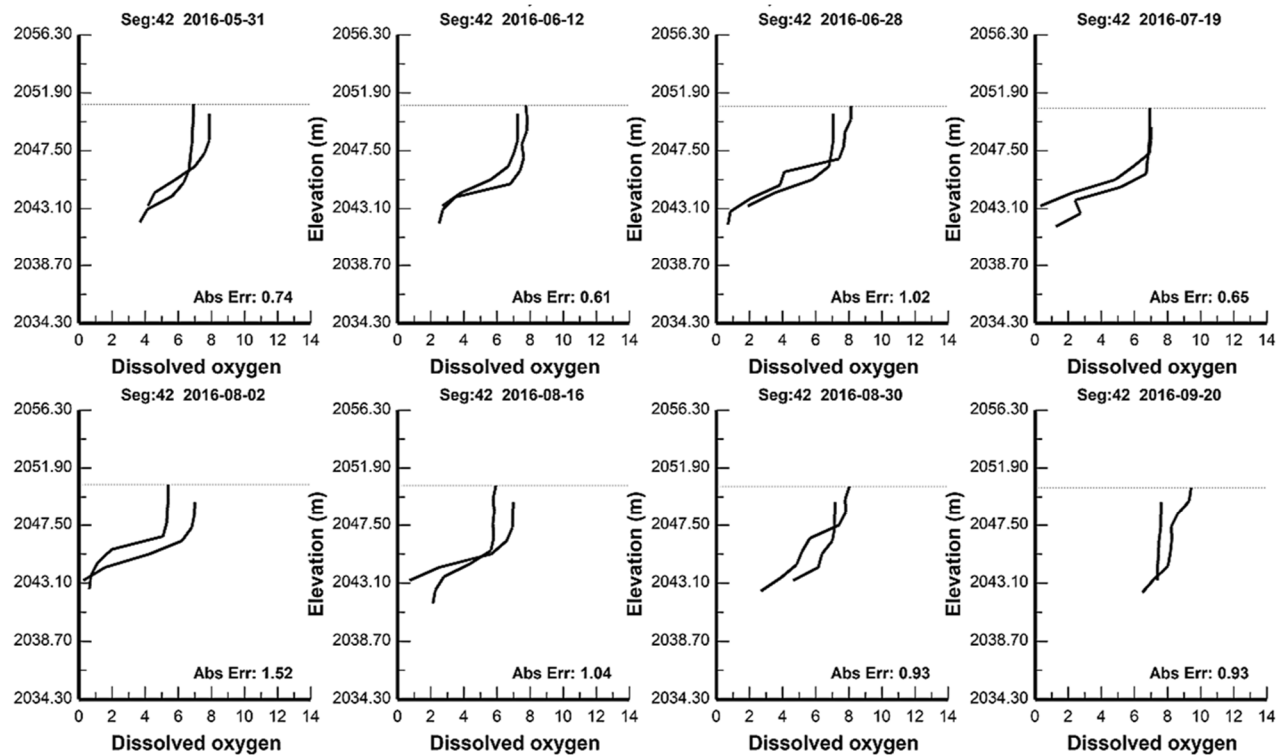

Figure 26. Example dissolved oxygen profiles at TMDL station #2 highlighting agreement between predicted and measured concentrations and periodic loss of DO in lower water column.

Table 17. Mean absolute error for model predictions of water column DO concentrations at the four TMDL sampling stations (145 profiles; 858-1974 discrete measurements in each profile).				
	#1 (Dam)	#2 (Gilner Pt)	#6 (Mid-lake)	#9 (Stanfield)
MAE (mg/L)	1.40	1.25	1.16	1.02

Summary

A 2-D (longitudinal-vertical) hydrodynamic -water quality model for Big Bear Lake was developed using CE-QUAL-W2. The 2-D laterally-averaged model grid was developed from the bathymetric survey data collected by Fugro Pelagos Inc. (2006). Hydrologic data defining inflows, outflows, and withdrawals were developed from annual Big Bear Water Master reports. Hourly meteorological conditions were taken from Big Bear Airport and California Irrigation Management Information System (CIMIS) Station #199 located at the golf course. Data included solar shortwave radiation, air temperature, dewpoint temperature, windspeed, wind direction and cloud cover. Cloud cover was determined from sky cover conditions reported in METAR data for the airport. The model was calibrated against measured lake level, *in situ* profiles of temperature and DO, and laboratory analyses of water samples collected at the lake for 2009-2019. The model was first developed and calibrated for lake level, water column temperature profiles and TDS, where generally very good agreement was achieved (mean absolute errors of 3.6 cm, 0.79-0.89 °C, and 11.9 mg/L, respectively). Following this, model calibration to water quality data was conducted. The model included external nutrient loading from the watershed,

atmospheric deposition, internal nutrient recycling, and nutrient uptake and release associated with macrophyte and epiphyton growth, senescence and death. Two algal groups were simulated, included one representing cyanobacteria capable of N₂-fixation. The 1st-order dynamic sediment model was combined with the 0th-order SOD model to simulate nutrient recycling and DO uptake in the surficial bottom sediments. Relative root mean square error was 17.7% for total P, 18.0% for total N, 29.5% for TIN, and 24.0 % for chlorophyll-a. Mean absolute errors for DO ranged from 1.02 – 1.40 mg/L for the 4 TMDL sampling stations.

IV. APPLICATION OF MODEL TO EVALUATE CONDITIONS WITH REPLENISH BIG BEAR PROJECT

With some confidence that the model is able to reproduce trends in water quality over a wide range of conditions, the model was used to evaluate changes in lake level and water quality under selected Replenish Big Bear project treatment scenarios. For these simulations, 1,920 af of BBARWA WWTP effluent was delivered annually through Stanfield Marsh and subsequently to the Lake. Three progressive levels of treatment assuming advanced nutrient removal and reverse osmosis (RO) technologies were evaluated (Treatment Alternatives):

- (i) Alternative 1: TIN & TP Removal
- (ii) Alternative 2: 70% RO (70% RO + 30% TIN & TP Removal)
- (iii) Alternative 3: 100% RO

The composition of the supplemental water used in simulations varied quite substantially depending upon level of treatment (Table 18).

Constituent (mg/L)	Alternative 1	Alternative 2	Alternative 3
TDS	450	150	50
NO ₃ -N	0.6	0.2	0.05
NH ₄ -N	0.2	0.1	0.05
PO ₄ -P	0.25	0.06	0.02
Dissolved Organic N	1.33	0.76	0.5
Dissolved Organic P	0.24	0.04	0.01
Particulate Organic N	0.07	0.04	0.00
Particulate Organic P	0.01	0.002	0.00

These three Treatment Alternatives, with varying concentrations of TDS, phosphorus, and nitrogen (Table 18), and a flow rate of 1,920 af/yr were simulated to evaluate effects of supplementation on lake levels and concentrations of TDS, nutrients and chlorophyll-a concentrations for comparisons with baseline (2009-2019) conditions. This analysis thus allows one to compare how different Replenish Big Bear Treatment Alternatives would have altered lake conditions over the past decade, which included extreme variations in lake level and water quality.

A. Lake Level

A simple water balance calculation indicates that 1,920 af/yr of water added to Big Bear Lake would add approximately 0.2 m/yr to lake level. This level of supplementation represents about a 20% increase in average total annual inflow on a calendar year basis, with substantially larger relative contributions during periods of drought (e.g., nearly doubling the very low inflow shown in Fig. 11a during 2013). Simulations confirm that supplemental water would have increased lake level substantially over the natural 2009-2019 period (Baseline scenario), up to 1.7 m by late 2018 relative to no project (Figure 27).

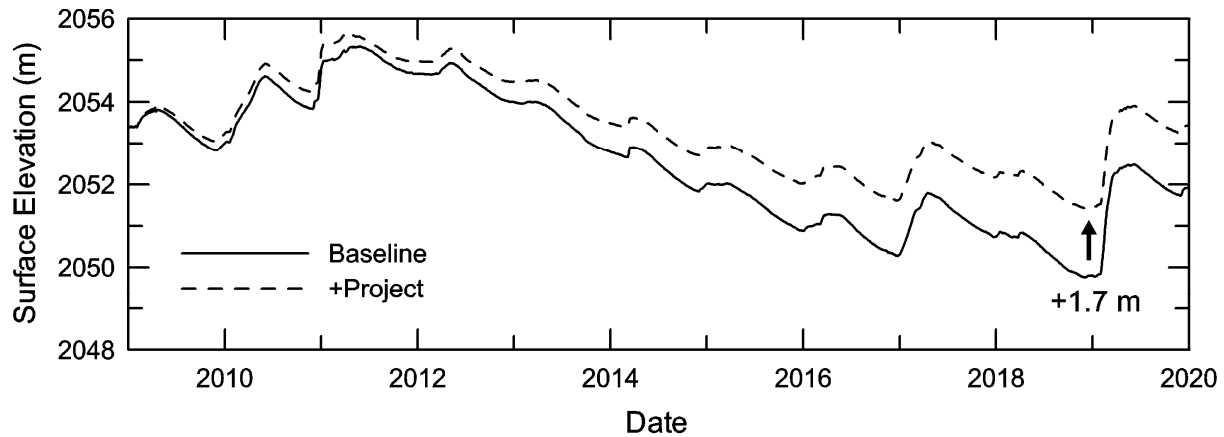

Figure 27. Predicted lake surface elevations over 2009-2019: baseline and with project.

B. Lake Area

The supplemental water also translates to increased lake surface area (Figure 28) that is a function of elevation-volume-area relationships for the Lake basin (Figure 9). Benefits of increased Lake area are especially evident during periods of drought, when Lake shoreline has substantially receded, limiting recreational and homeowner access, and resulting in extensive loss of the littoral community. For example, supplementation with project water would have increased lake area by about 300 acres, from less than 1,900 acres in 2018 to nearly 2,200 acres (Fig. 28). Moreover, the benefits of supplementation to Lake level and Lake surface area in terms of recreational access, aesthetics, ecological habitat, etc. accrue over time, especially evident during drought, until large inflows restore lake level and reset hydrologic conditions in the Lake.

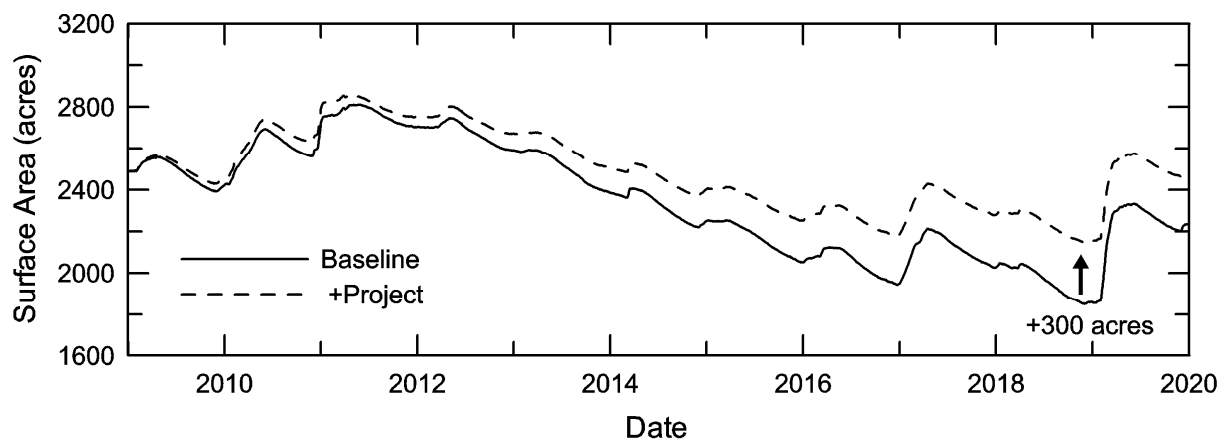

Figure 28. Predicted lake surface area over 2009-2019: baseline and with project.

C. TDS

Addition of 1,920 AFY of Alternative 1 effluent with a TDS of 450 mg/L, predictably increased TDS relative to the Baseline scenario, while Alternative 2 effluent yielded predicted TDS concentrations similar to those present in 2009-2019, and Alternative 3 effluent lowered TDS levels below the Baseline scenario (Figure 29; Table 19).

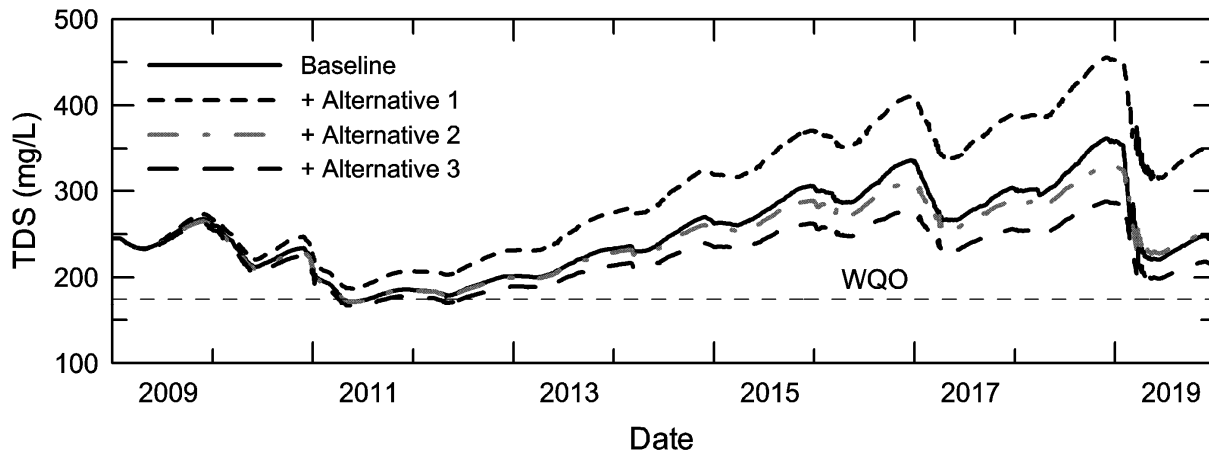

Figure 29. Predicted TDS concentrations over 2009-2019: baseline and with project.

Predicted TDS for the Baseline scenario exceeded the WQO of 175 mg/l (dashed line) 97.6% of the time over 2009-2019, a frequency equivalent to that of the Alternative 2 treatment scenario, and greater than that with Alternative 3 treatment scenario (Table 19).

Table 19. Summary of TDS concentrations for 2009-2019 under natural conditions and with project.			
Scenario	Average TDS (mg/L)	Range TDS (mg/L)	WQO Exceedance Frequency (%)
Baseline	251	172-362	97.6
Alternative 1	300	187-455	100.0
Alternative 2	244	171-329	97.6
Alternative 3	226	166-287	93.3

D. Nutrients and Chlorophyll-a

Nutrients entering the lake add to the inventory of nutrients already present, which are subject to a wide array of biogeochemical processes. To help put nutrients derived from supplemental water of differing levels of treatment into context, it is useful to consider their composition and loading relative to watershed sources. Median watershed concentrations and concentrations in Alternative 1-3 effluents are provided in Table 20. Alternative 1 effluent substantially exceeds median watershed concentrations for virtually all nutrients, while addition of RO in Alternatives 2 and 3 lowers concentrations, often to levels comparable to or in some cases below median watershed levels.

Final Report

Variable	Median Watershed Concentrations (mg/L)					Nutrient Concentrations (mg/L)		
	Boulder Cr	Grout Cr	Knickerb Cr	Rathbun Cr	Summit Cr	Alt 1	Alt 2	Alt 3
NO ₃ -N	0.05	0.183	0.13	0.419	0.19	0.6	0.2	0.05
NH ₄ -N	0.011	0.01	0.015	0.015	0.015	0.2	0.1	0.05
PO ₄ -P	0.007	0.015	0.038	0.038	0.021	0.25	0.06	0.02
Total N	0.184	0.378	0.312	0.716	0.481	2.2	1.1	0.6
Total P	0.009	0.023	0.055	0.055	0.075	0.5	0.1	0.03
TN/TP	20.4	16.4	5.7	13.0	6.4	4.4	11	20

Normalizing project concentrations as ratios to median watershed concentrations allows comparison of relative enrichment factors for supplemental water (concentration basis) (Table 21):

Variable	Concentration Enrichment Factor		
	Alternative 1	Alternative 2	Alternative 3
NO ₃ -N	3.3	1.1	0.3
NH ₄ -N	13.3	6.7	3.3
PO ₄ -P	11.9	1.6	0.5
Total N	5.8	2.3	0.8
Total P	9.1	1.8	0.4

One thus recognizes that Alternative 1 (TIN & TP Removal) effluent represents about 6-times and 9-times greater concentrations of TN and TP, respectively, compared with the watershed, while Alternative 2 (70% RO) is on the order of about 1-2 times higher concentrations, and Alternative 3 (100% RO) is significantly lower than typical concentrations of most forms of nutrients delivered from the watershed (Table 21). Importantly, Alternative 1 effluent is not only much higher in nutrient concentrations, it also has a very low TN:TP ratio (Table 20), that could potentially favor N₂-fixing blue-green algae.

Simulations demonstrated that water quality in the Lake is broadly similar between the Baseline scenario and the Alternative 2 and 3 treatment scenarios, but is significantly degraded with Alternative 1 effluent, with marked predicted increases in TP, TN, and chlorophyll-a concentrations (Figure 30).

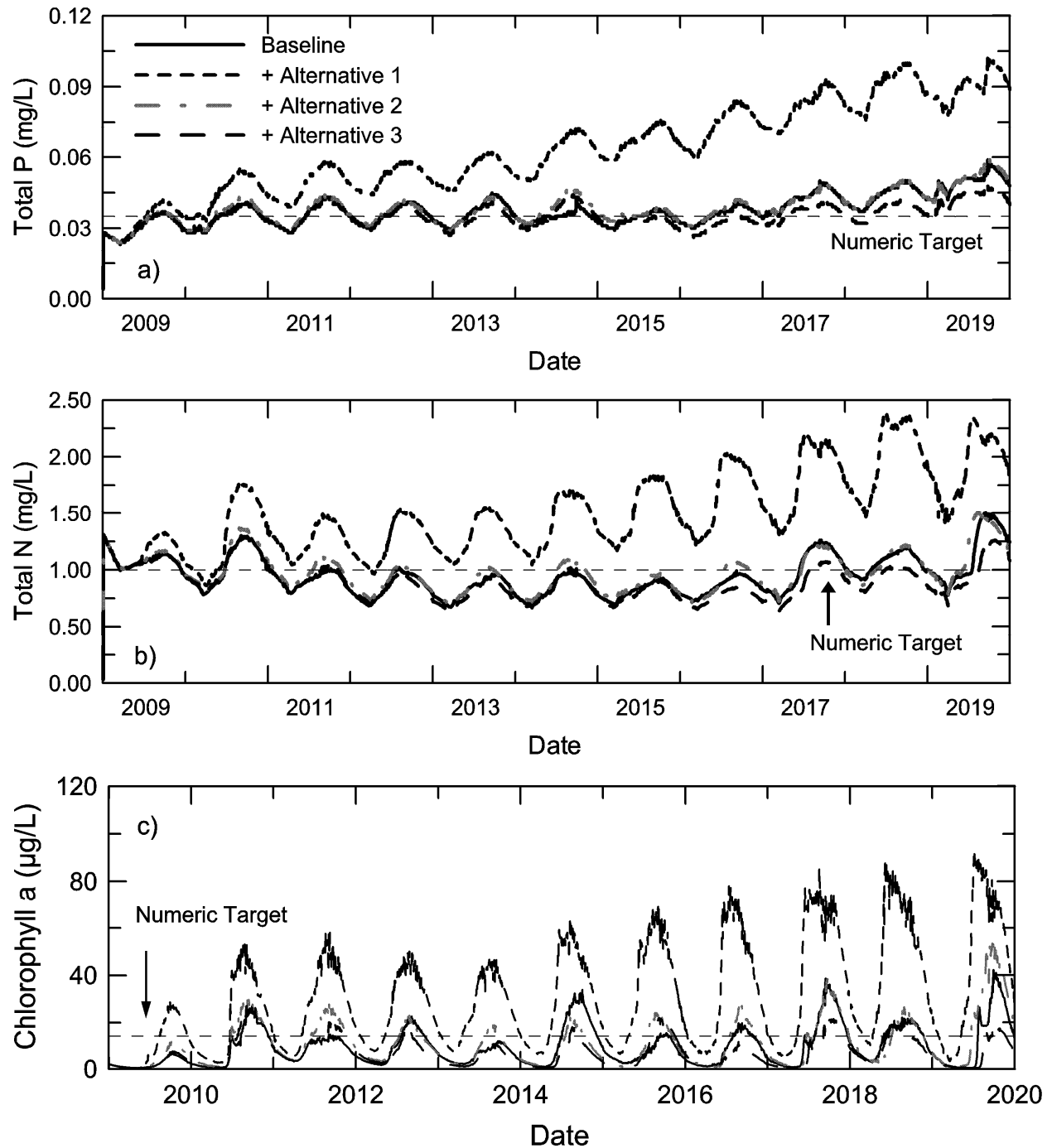

Figure 30. Predicted concentrations of a) total P, b) total N, and c) chlorophyll-a at TMDL station #2 (photic zone).

Supplementation with Alternative 1 effluent also significantly increased littoral plant production, often doubling peak values relative to that predicted under the Baseline scenario and with treatment alternatives 2 and 3 (Figure 31).

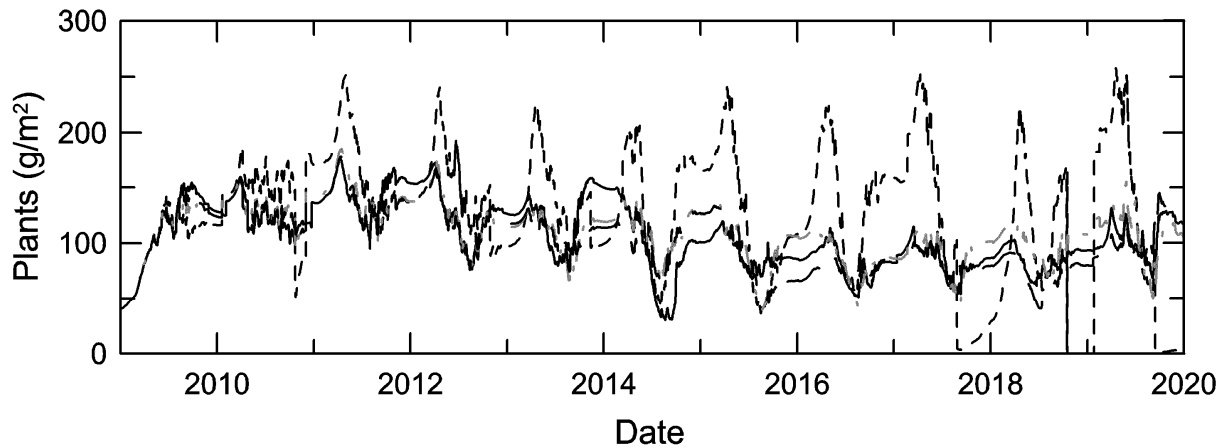

Figure 31. Predicted plant biomass at TMDL station #2 (photic zone). Legend shown in Fig. 30a.

Average concentrations at TMDL station #2 (Gilner Point) for the 11-yr simulation period highlight substantial predicted increases in total P, PO₄-P, and total N resulting from supplementation with Alternative 1 effluent (Table 20). The large increase in P concentrations also yielded a substantial increase in predicted average chlorophyll-a concentration (30.5 vs 9.3 µg/L). Supplementation with Alternative 1 effluent also increased TIN concentrations compared with the Baseline scenario and increased (non-phytoplankton) plant production. Supplementation with Alternative 2 effluent yielded predicted average water quality quite similar to the Baseline scenario, while supplementation with Alternative 3 effluent was predicted to improve average water quality somewhat (Table 22).

Scenario	Total N (mg/L)	Total P (mg/L)	Chl a (µg/L)	PO ₄ -P (µg/L)	TIN (mg/L)	Plants (g/m ²)
Baseline	0.948	0.037	9.3	3.5	0.049	106.9
Alternative 1	1.511	0.063	30.5	7.8	0.120	126.3
Alternative 2	0.979	0.038	10.9	3.6	0.047	110.2
Alternative 3	0.894	0.035	7.1	3.3	0.046	103.1

Supplementation of treated effluent from the BBARWA WWTP is thus predicted to yield different water quality in Big Bear Lake depending upon effluent water quality. Supplementation with Alternative 1 effluent is predicted to substantially increase lake total P and PO₄-P concentrations, which may also increase N₂-fixing blue-green algae, as well as increase epiphyte and macrophyte production. Supplementation with Alternative 2 effluent is predicted to yield water quality conditions similar to natural conditions, while providing increased lake volume, lake surface area, and additional (non-planktonic) plant biomass. Further treatment of effluent in Alternative 3 was predicted to slightly improve water quality compared with that predicted for the 2009-2019 Baseline scenario.

Cumulative distribution functions for basin-wide volume-averaged concentrations of TP and TN highlight the substantial increase in nutrients that would result from the addition of Alternative

Final Report

1 effluent, while also demonstrating that Alternative 2 effluent is predicted to yield nutrient levels similar to predicted 2009-2019 levels, while supplementation with Alternative 3 effluent is predicted to yield slightly improved (lower) concentrations (Figure 32).

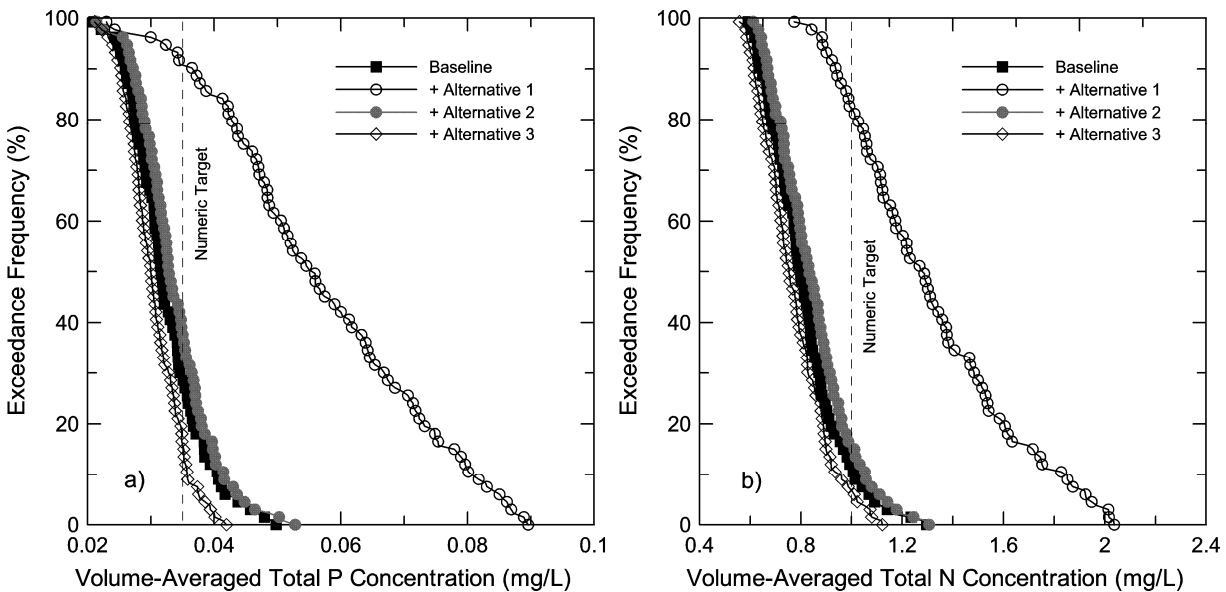

Figure 32. Cumulative distribution functions for predicted baseline and supplementation scenarios of volume-weighted concentrations of a) total P and b) total N.

Summary

Supplementation of natural flows with 1,920 af/yr of Replenish Big Bear water was predicted to add about 0.2 m annually to the lake relative to levels observed in 2009-2019 (baseline), and which accrued over time such that the lake was predicted to be 1.7 m higher in late 2018 compared to the level present at that time. Supplementation also increased lake volume and surface area, with lake area about 300 acres (16%) larger in late 2018 compared with actual area (approximately 2200 acres vs 1900 acres, respectively). Addition of 1,920 af/yr of Alternative 1 water significantly increased TDS levels in the lake, increasing average predicted TDS from 251 mg/L for the baseline (natural) condition for 2009-2019 to 300 mg/L, while Alternatives 2 and 3 were predicted to yield slightly lower average TDS concentrations of 244 and 226 mg/L, respectively. Exceedance of the TDS water quality objective of 175 mg/L was predicted to occur 97.6% of the time for both the baseline condition and for Alternative 2, while exceedance frequency increased to 100% for Alternative 1 and was reduced to 93.3% for Alternative 3.

Nutrient concentrations in the Replenish Big Bear water varied markedly with treatment, with total N and total P concentrations in Alternative 1 being about 6-9x higher than median watershed concentrations, while concentrations in Alternative 2 were projected to be 1.8-2.3x larger and Alternative 3 being about 0.4-0.8x that of median watershed values. The increased nutrient loading from Alternative 1 had a strongly detrimental effect on water quality, increasing average concentrations over 2009-2019 baseline of total N by about 50%, total P by 70%, and chlorophyll-a by 300%. In comparison, further treatment of effluent yielded average

concentrations comparable to (Alternative 2) or slightly improved (Alternative 3) relative to the baseline (natural no-project) condition.

V. PREDICTED LONG-TERM FUTURE CONDITIONS WITH REPLENISH BIG BEAR PROJECT

Simulations were extended from the reference period (2009-2019) to include 30 additional years, for a total of 41 simulation years that yielded potential trajectories for water level, area, TDS, and nutrients out to the beginning of 2050. As previously noted, the model requires extensive data for meteorological conditions (air temperature, dewpoint temperature, wind speed, wind direction, cloud cover, and solar radiation), as well as water inflows, outflows, and withdrawals. While hourly weather forecasts are available 7-10 days in advance from the National Weather Service (NWS) and 5-10 day flow forecasts are available for limited gaged stations from the NWS River Forecast Centers, we obviously do not know *a priori* these detailed meteorological and hydrological conditions for the next 30 years. Similarly, while downscaled global climate models provide some projections about trends in air temperature and precipitation, they do not provide information with sufficient resolution to allow direct use in our simulations.

Given these constraints, existing meteorological and flow data for 2009-2019 were used as the basis for forecasts. (An effort was made to expand the meteorological record to include additional years, but available weather data for the Big Bear Airport only go back to April 2007, thus providing only one additional full year of record, so existing data were used.) The 2009-2019 period included record or near record air temperatures and intervals of both extreme drought and very high precipitation/runoff that captured much of the anticipated inter-annual variability in meteorology and hydrology (e.g., Table 23). For example, average precipitation over 2009-2019 period was not statistically significantly different than that of the past 43 years (e.g., 31.7 ± 15.6 vs 34.8 ± 14.7 in/yr at Bear Valley Dam). Precipitation was better described as log-normally distributed; however, with geometric mean values very similar to median values, and both being slightly lower (reflecting increased prevalence of drought) but well-captured in the 2009-2019 dataset. Perhaps more importantly, minimum and maximum values for the 2009-2019 period were also similar to the larger 1977-2019 dataset (e.g., the highest annual precipitation at the Big Bear Community Services District (BCCSD) was recorded in 2010, within the 2009-2019 record).

Precipitation (in/yr)	Bear Valley Dam		BCCSD	
	1977-2019	2009-2019	1977-2019	2009-2019
Average	34.8	31.7	14.9	17.5
Geometric Mean	31.6	29.1	13.3	16.3
Median	31.8	27.8	14.1	14.8
Minimum	13.2	14.4	3.8	8.2
Maximum	73.8	64.1	33.2	33.2

Assuming that 2009-2019 is broadly representative of likely future meteorological and hydrologic conditions, Monte Carlo techniques were used to randomly select 100 different 30-year annual records from this set of data. Thus, any given future year was assumed to essentially have a 1-in-11 chance of looking like any one of the years from the 2009-2019 period in terms of meteorological conditions, inflows, withdrawals, and releases for downstream flow

Final Report

requirements. Impacts of climate change were considered; air temperature increases would increase evaporation losses from lake, but also likely yield more rain and rain-on-snow events that would increase runoff and inflows to lake. Without detailed watershed modeling, it is not possible to resolve these conflicting impacts on the water budget for the lake, so for the purposes of this analysis, they were assumed to cancel out. The Monte Carlo analysis yielded 30-year average flow rates that ranged from 6,891 to 15,115 af/yr (Figure 33). Individual year flow rates varied more widely, ranging from 1,961 – 27,579 af/yr (not shown).

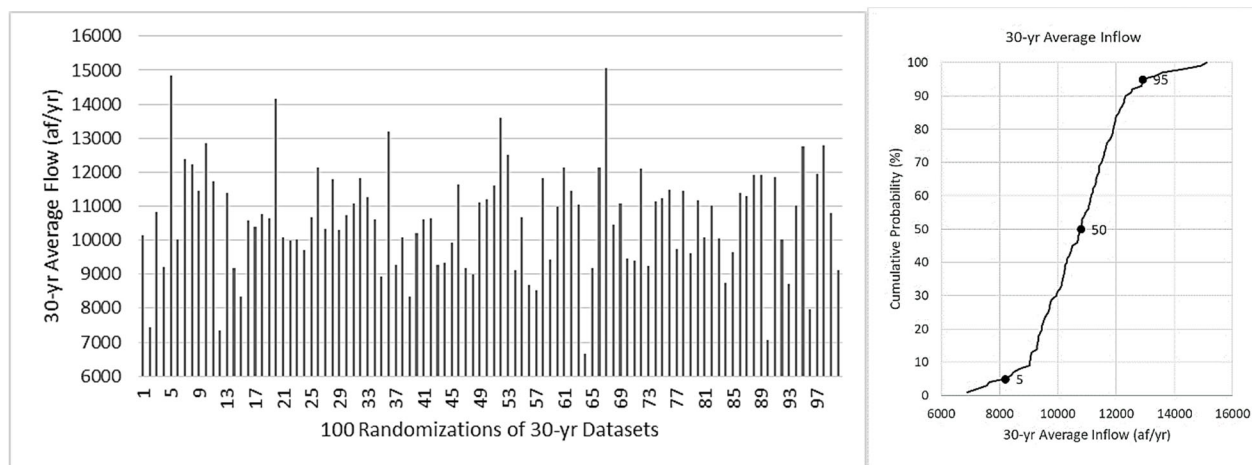

Figure 33. Thirty year average flow rates for 100 random datasets.

From this dataset (Figure 33), three hydrologic scenarios were selected for further analysis corresponding to the 5th-percentile, 50th-percentile (median), and 95th-percentile 30-yr average flow rates. The 5th-percentile corresponds to an average inflow rate of 8,646 af/yr and represents extended drought, not unlike that present in the 1950's-60's, while the 50th-percentile hydrologic scenario corresponds to intervals of both high runoff and drought, comparable to 2009-2019 (average annual inflow of 10,595 af/yr), and the 95th-percentile represents a period of protracted above average rainfall and runoff (average annual inflow of 12,225 af/yr). Cumulative inflows for these 3 hydrologic scenarios are presented in Figure 34. The corresponding meteorological, outflow and withdrawal conditions were used as input for CE-QUAL-W2 simulations. The 3 simulations represent forecasts of conditions subject to the temporal boundary conditions (inflows, meteorological conditions, etc.), and thus are not predictive of conditions at specific points of time in the future. On that basis, results are presented as cumulative distribution functions rather than time-series to convey information in a statistical-probabilistic framework rather than as strict forecasts in time. Lake properties are contrasted between baseline conditions under the 3 hydrologic scenarios and with implementation of the Replenish Big Bear project.

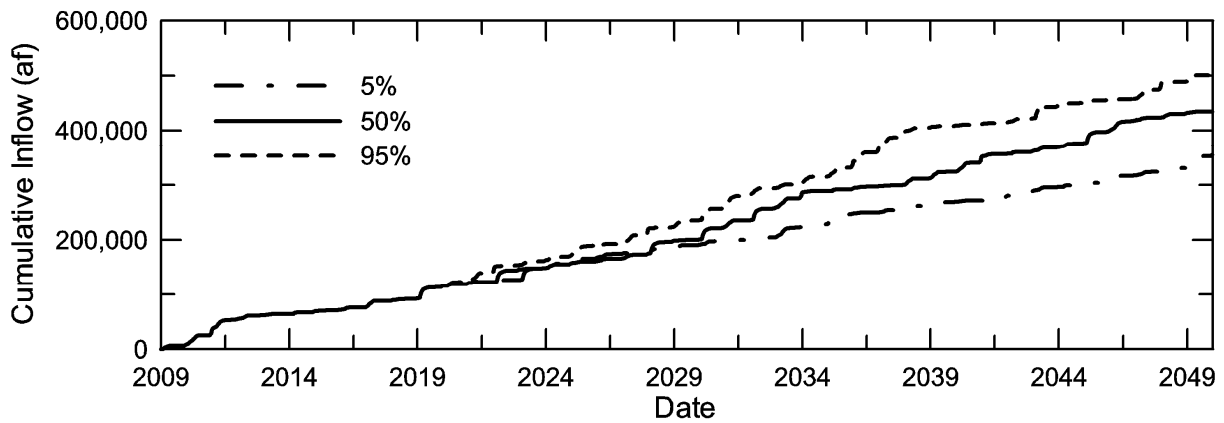

Figure 34. Cumulative inflows under 5th-, 50th- and 95th-percentile 30-yr average hydrologic scenarios.

A. Lake Surface Elevation

The 3 hydrologic scenarios had pronounced effects on predicted lake levels, with the 5th-percentile (chronic drought) scenario yielding elevations as low as 2044.9 m above MSL and a median elevation of 2048.8 m (Figure 35a). The 50th- and 95th-percentile hydrologic scenarios yielded predictably higher lake levels (e.g., median levels of 2052.2 and 2053.1 m, respectively) (Figure 35a). Supplementation with 1,920 af/yr of Replenish Big Bear water markedly increased lake levels, e.g., raising the minimum level for 5th-percentile scenario by up to 4.6 m and increasing median level from 2048.8 m for baseline to 2052.0 m (Figure 35b).

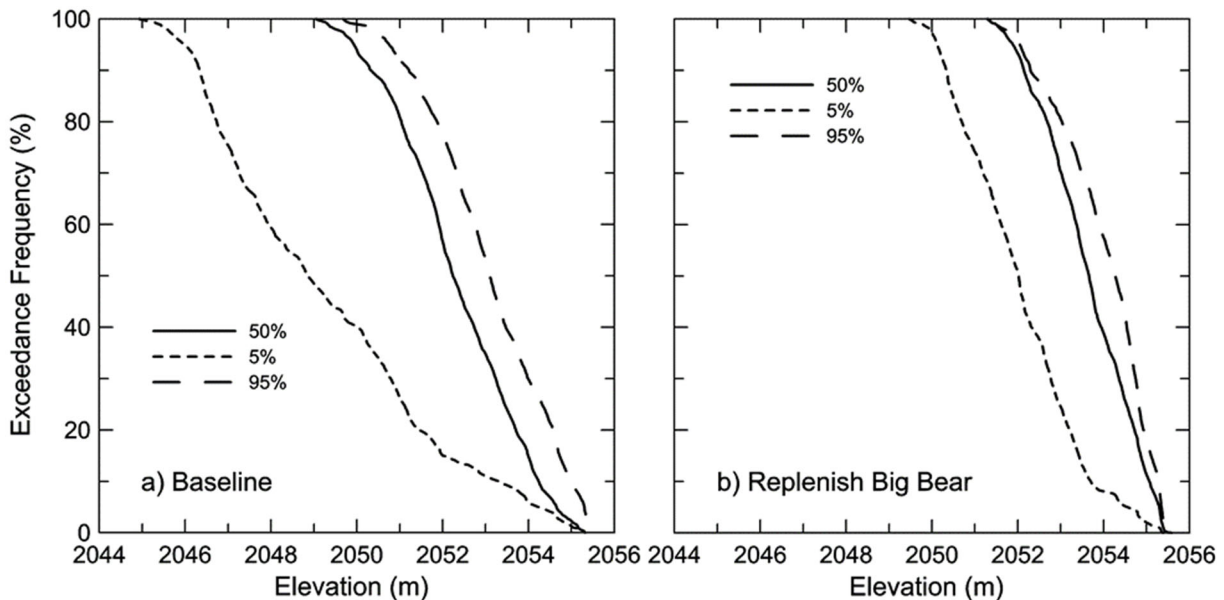

Figure 35. CDFs of predicted lake elevations at 5th-, 50th- and 95th-percentile hydrologic scenarios for a) baseline conditions and b) supplementation with Replenish Big Bear water.

B. Lake Volume

Supplementation also substantially increased lake volumes, with volumes potentially as low as 6,000 af and a median volume of about 23,000 af for the 5th-percentile (drought) scenario (Figure 36). Supplementation with Replenish Big Bear water resulted in significant increases in lake volume for the other hydrologic scenarios as well (Figure 36).

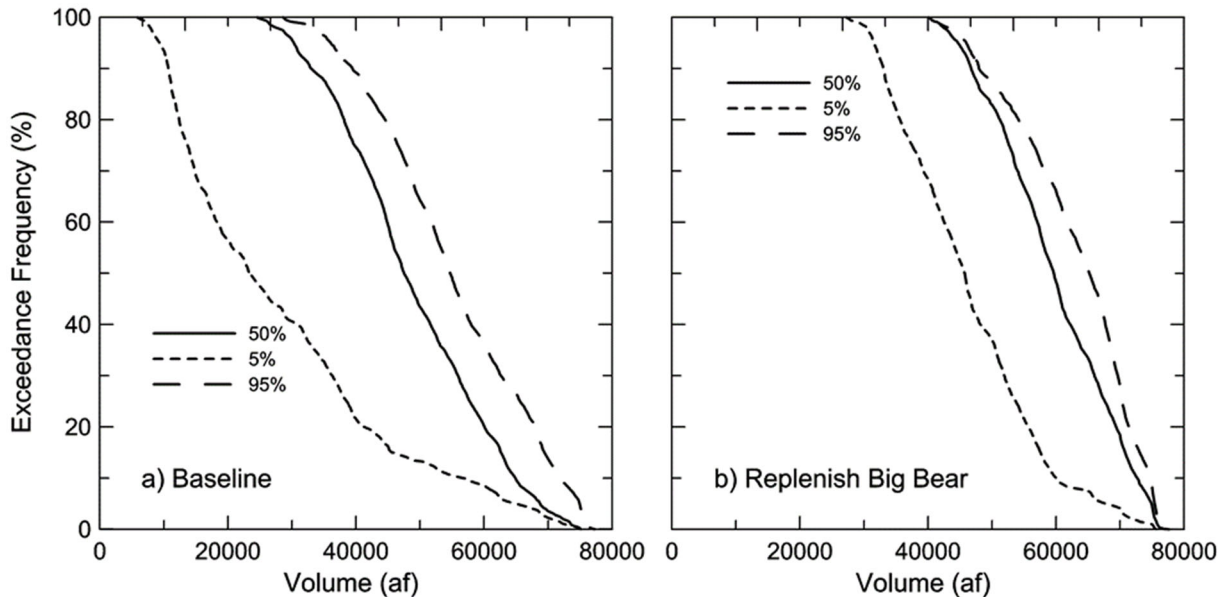

Figure 36. CDFs of predicted lake volumes at 5th-, 50th- and 95th-percentile hydrologic scenarios for a) baseline conditions and b) supplementation with Replenish Big Bear water.

C. Lake Surface Area

The 5th-percentile hydrologic scenario also yielded very low lake surface areas, potentially <1000 acres and a median area of about 1700 acres (Figure 37a). The minimum predicted lake surface areas were about 2x larger and median surface areas were approximately 2300 and 2500 af for the 50th- and 95th-percentile hydrologic scenarios, respectively. Supplementation substantially increased lake area, shifting all CDFs to higher area values (Figure 37b). This can be seen more graphically in Figure 38, where the areas corresponding to the minimum and 75% exceedance frequencies (predicted to occur 25% of the time under the simulated protracted drought condition) are projected onto the natural lake boundary for the baseline and with project. At the minimum area, the lake divides into the impounded area behind the dam and a 2nd very shallow mid-basin, while the Project is able to maintain an extensive and contiguous lake area through the main body of the lake (Figure 38a). A considerable additional area is also maintained at the 75% exceedance frequency with supplementation (Figure 38b).

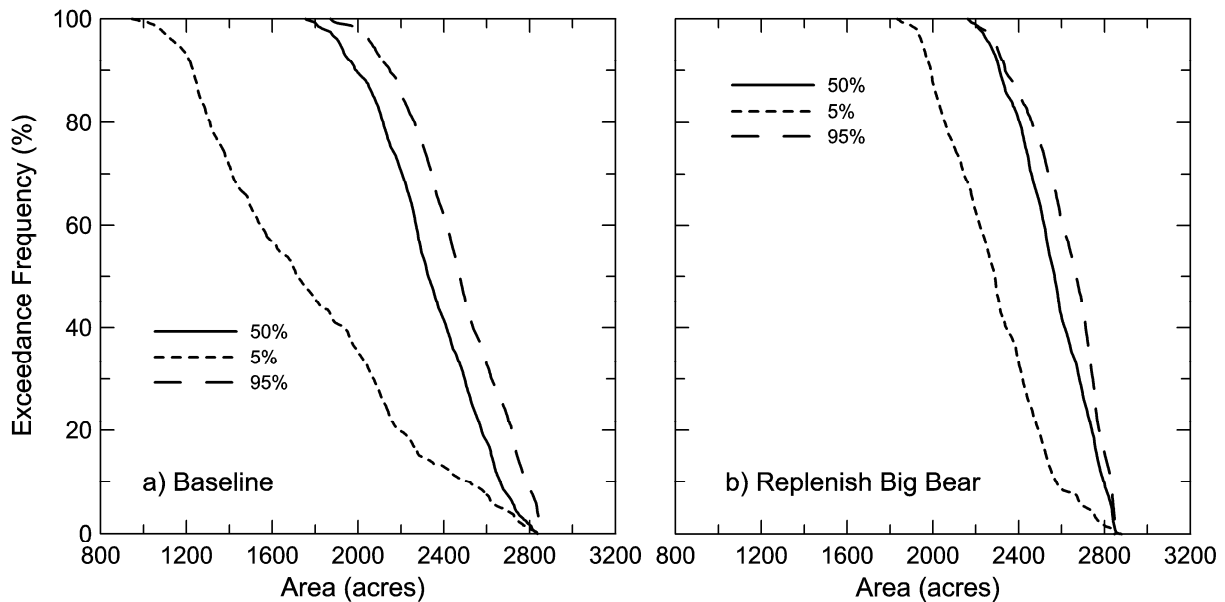

Figure 37. CDFs of predicted lake areas at 5th-, 50th- and 95th-percentile hydrologic scenarios for a) baseline conditions and b) supplementation with Replenish Big Bear water.

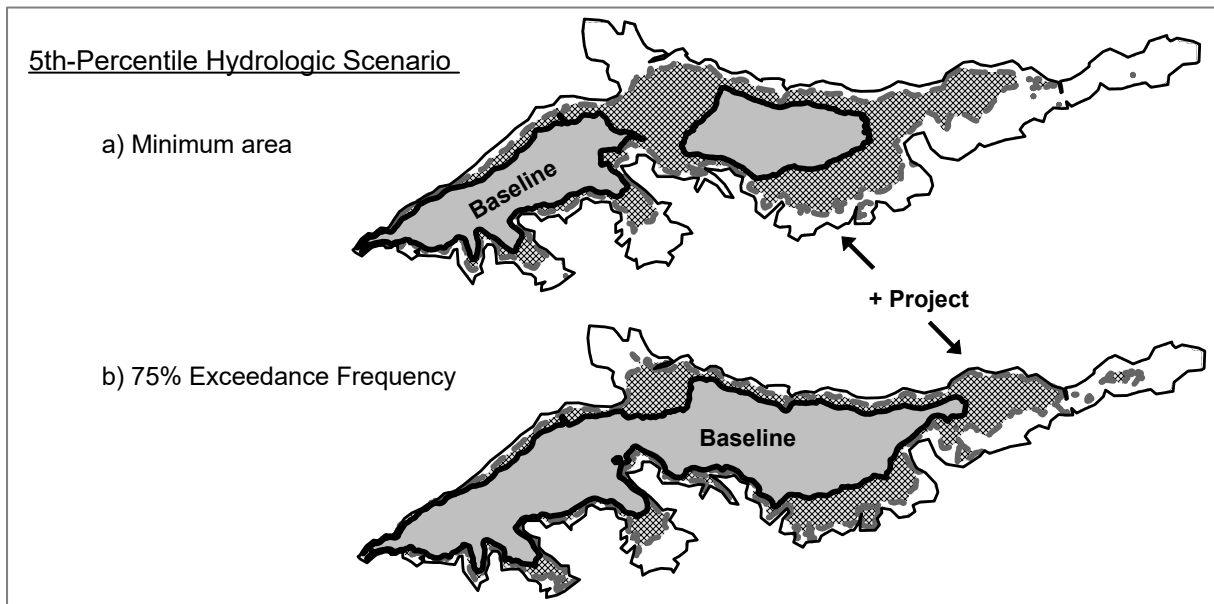

Figure 38. Lake surface under 5th-percentile flows (protracted drought) depicting areas under baseline conditions (solid gray) and with project (cross-hatched) at a) minimum area and b) 75% exceedance frequency (predicted to occur 25% of the time under the simulated protracted drought condition).

D. Total Dissolved Solids

The concentrations of TDS in Big Bear Lake vary naturally as a function of lake level as a result of runoff inputs and evapoconcentration. Thus, predicted TDS concentrations were greatest for the 5th-percentile hydrologic scenario (protracted drought) and lower for the 50th- and 95th-percentile hydrologic scenarios (Figure 39a). Unlike lake elevation, volume and area which are independent of the type of effluent treatment, predicted TDS concentrations in the lake are quite sensitive to it (Figure 39b-d).

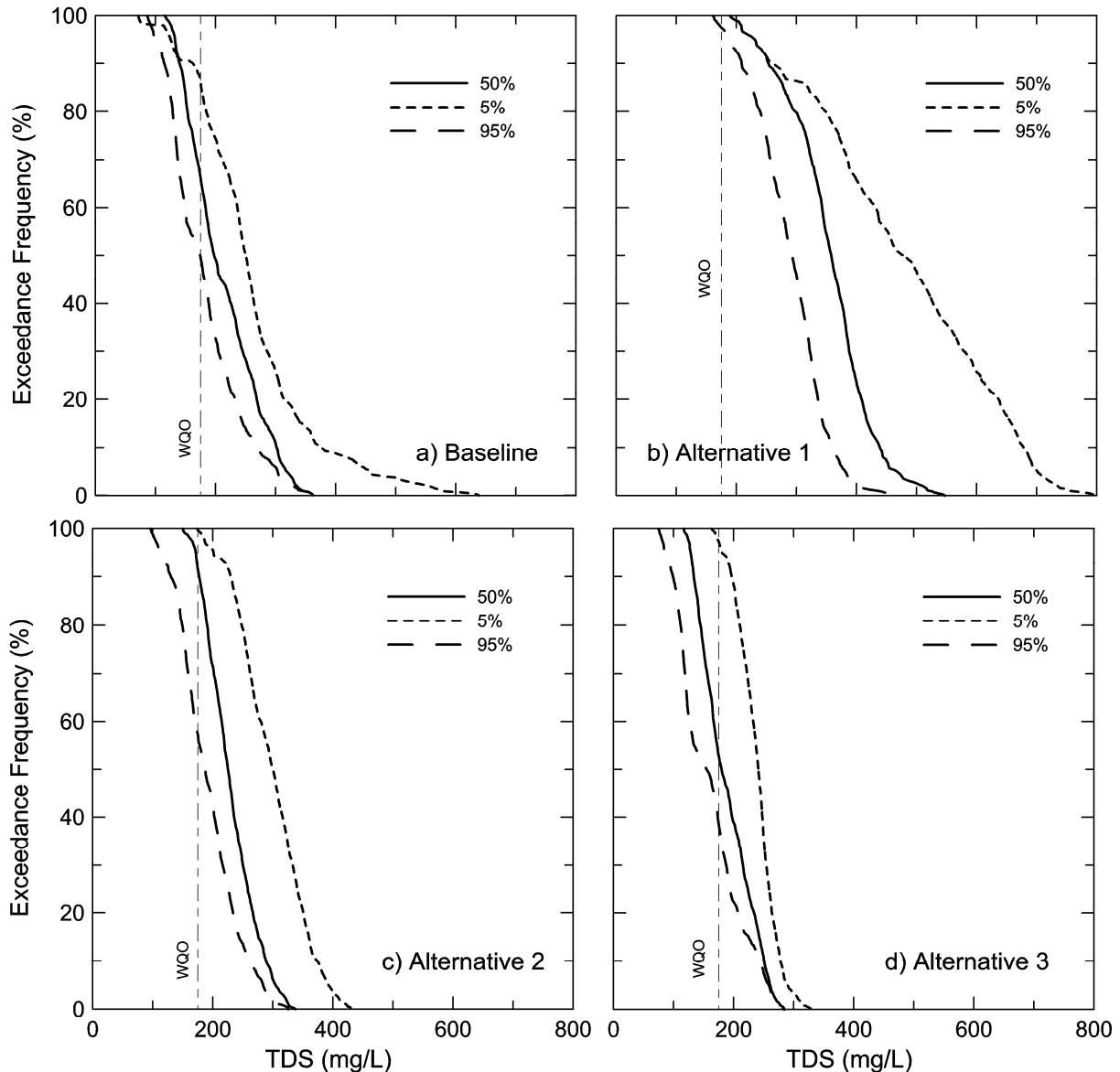

Figure 39. CDFs of predicted lake TDS at 5th-, 50th- and 95th-percentile flows for a) baseline conditions, and supplementation with b) Alternative 1, c) Alternative 2 and d) Alternative 3 water.

Alternative 1 treatment, involving only nutrient removal, yielded high concentrations of TDS that was predicted to exceed the water quality objective by wide margins (Figure 38b), while Alternative 2 shifted CDFs from baseline to slightly higher TDS levels, and the highest level of treatment (Alternative 3) yielded slightly lowered concentrations relative to Baseline scenario (Figure 39c,d).

E. Total P

Total P concentrations for the baseline condition were predicted to vary under the 3 hydrologic scenarios, exceeding 0.05 mg/L with some frequency under the drought scenario (Figure 40a).

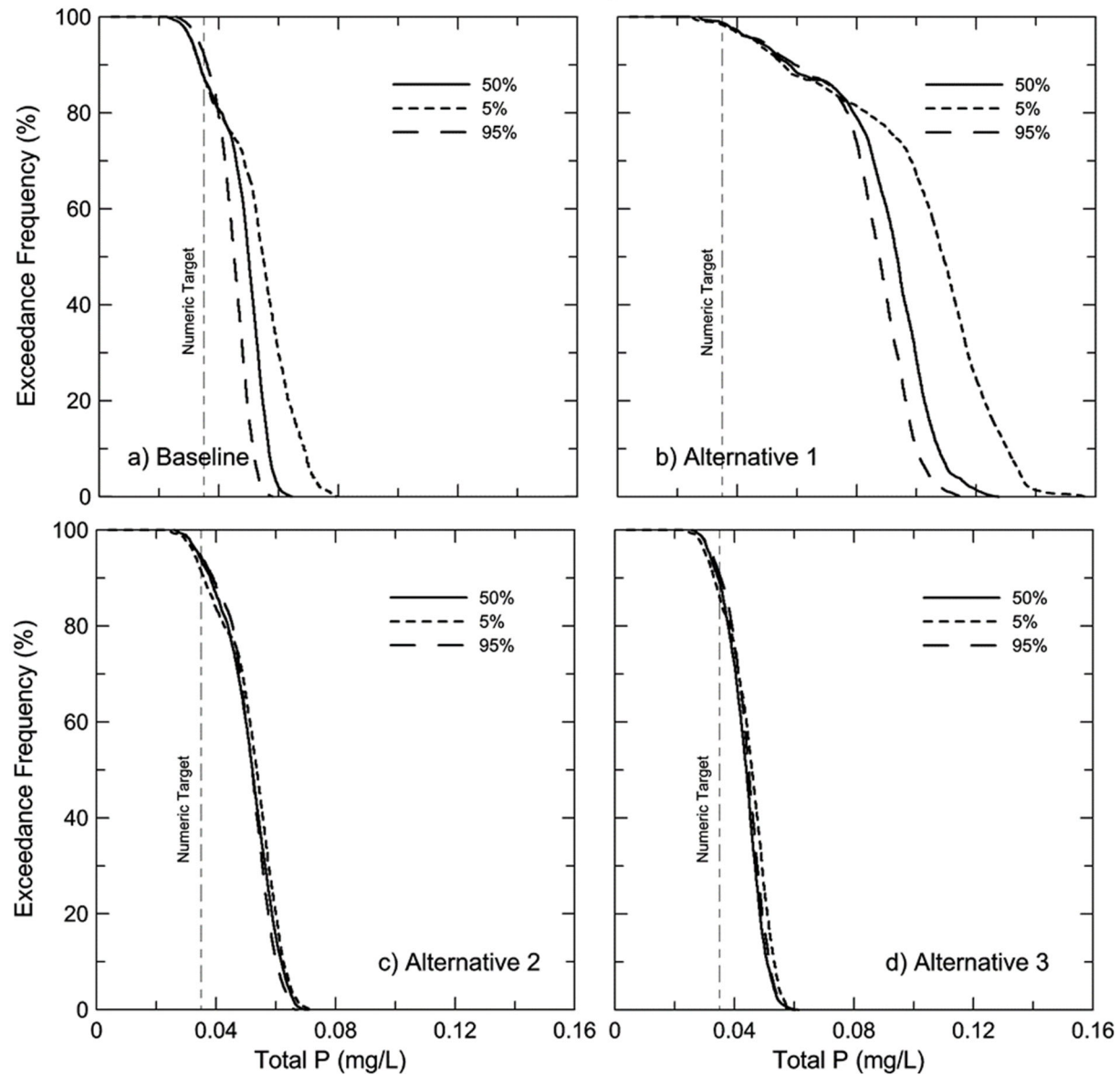

Figure 40. CDFs of predicted total P levels at 5th-, 50th- and 95th-percentile hydrologic scenarios for a) Baseline, and supplementation with b) Alternative 1, c) Alternative 2 and d) Alternative 3 water.

Final Report

As noted in simulations for 2009-2019, supplementation with Replenish Big Bear effluent substantially degraded predicted water quality, and increased total P (Figure 40b), as well as total N (Figure 41b) and chlorophyll-a (Fig. 42b). Supplementation with higher quality Alternative 2 and 3 water reduced natural variability and provided comparable or lower levels (Figure 40c,d).

F. Total N

Figure 41. CDFs of predicted total N levels at 5th-, 50th- and 95th-percentile hydrologic scenarios for a) baseline conditions, and supplementation with b) Alternative 1, c) Alternative 2 and d) Alternative 3 water.

Predicted total N concentrations (Figure 41) followed the same trends as total P (Figure 40), with Alternative 1 significantly increasing concentrations, while Alternatives 2 and 3 reduced variability in baseline case due to stabilization of lake level with high quality water (Figure 41).

G. Chlorophyll-a

Chlorophyll-a concentrations followed similar trends as noted for total P and total N, with a >5x increase in median predicted concentrations with Alternative 1 compared with baseline, while Alternatives 2 and 3 yielded comparable or slightly higher predicted concentrations (Figure 42).

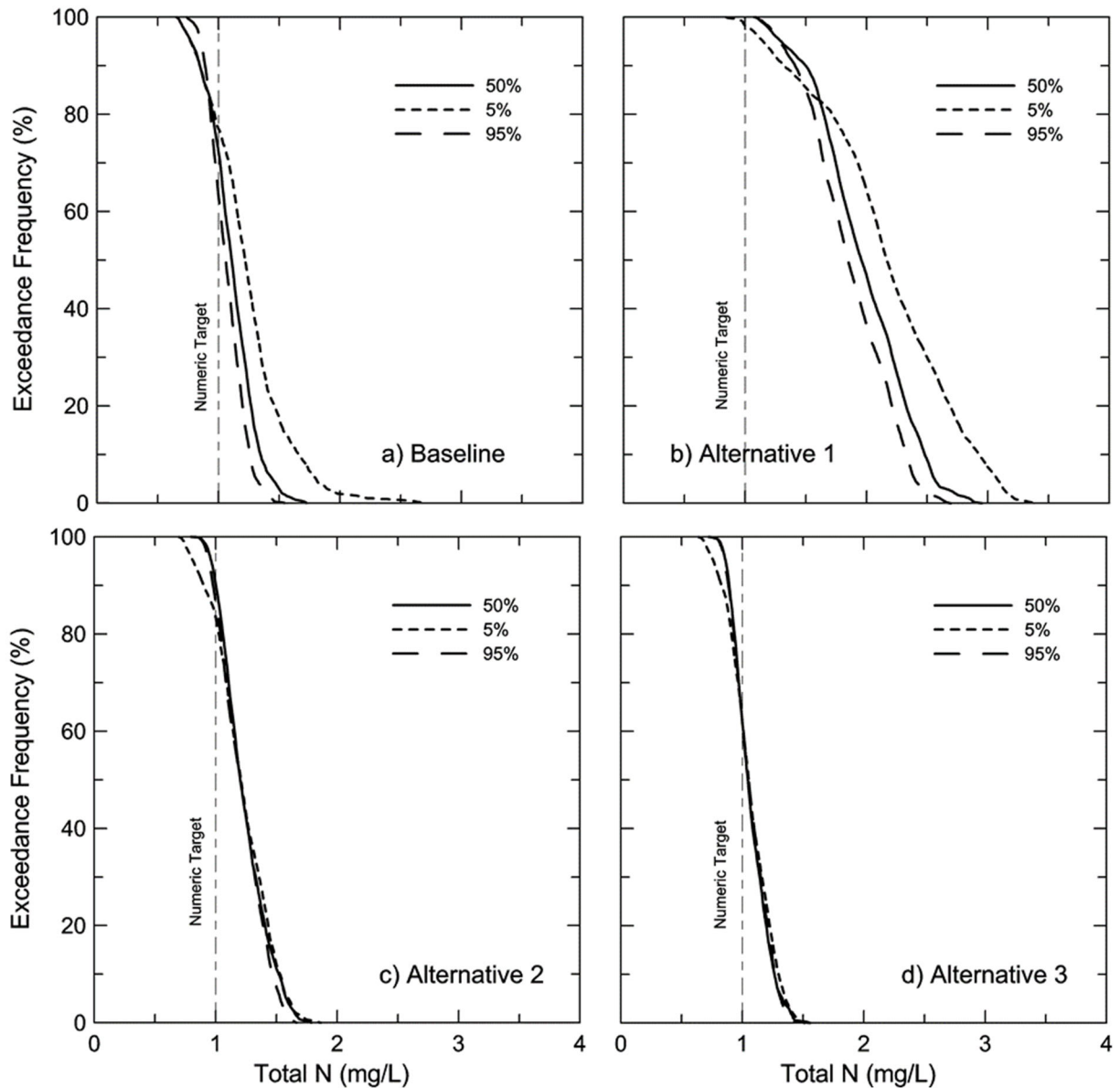
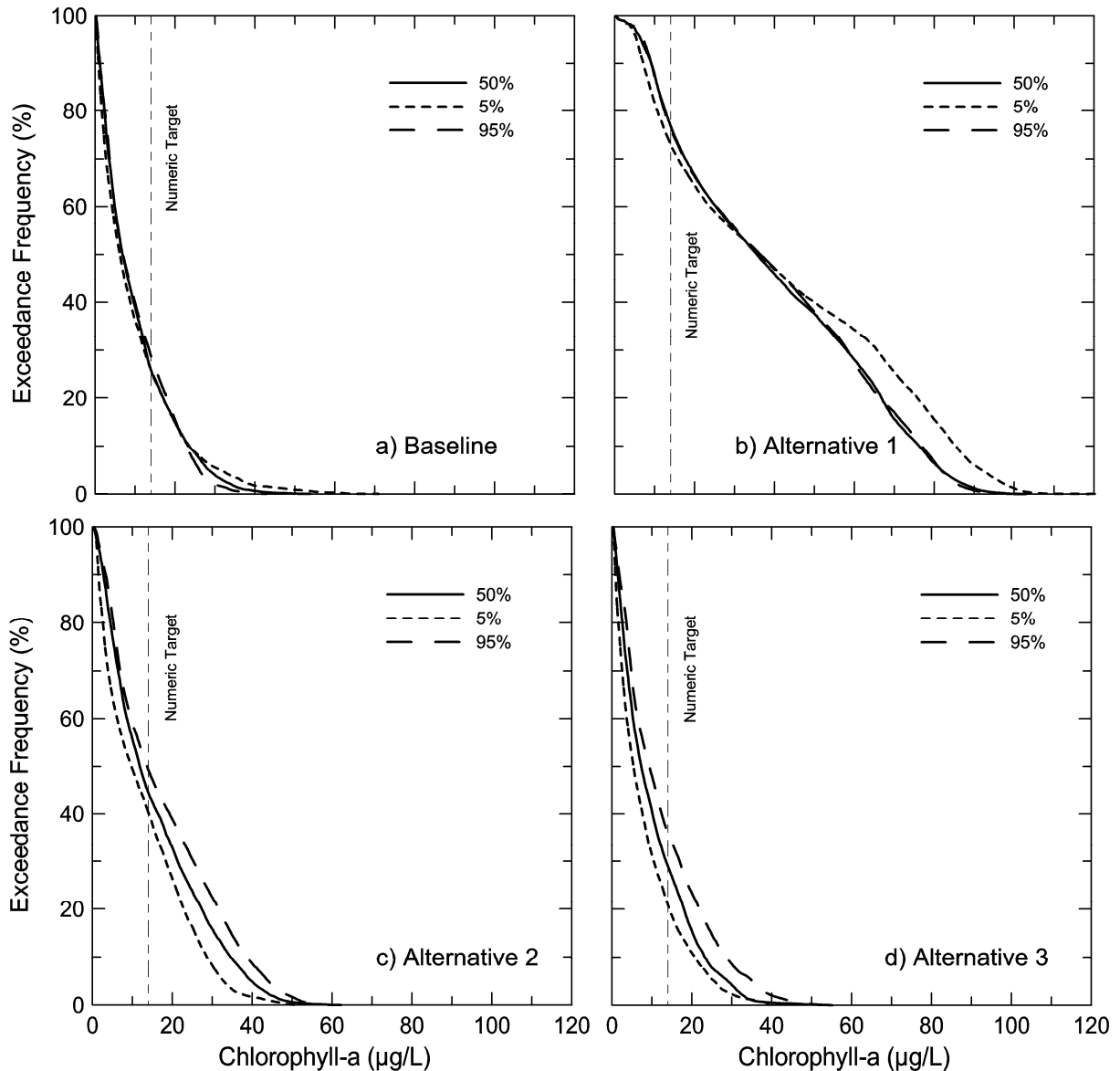

Figure 42. CDFs of predicted chlorophyll-a levels at 5th-, 50th- and 95th-percentile hydrologic scenarios for a) Baseline, and supplementation with b) Alternative 1, c) Alternative 2 and d) Alternative 3 water.

Final Report

CDF Summary

CDFs convey a great deal of information, although it is often not easy to readily resolve differences across multiple graphs. Median lake dimensions for the 3 different hydrologic scenarios with and without supplementation with water from the Replenish Big Bear project from Figures 34-36 are summarized in Table 24.

Parameter	Scenario	5 th -Percentile	50 th -Percentile	95 th -Percentile
Elevation (m)	Baseline	2048.9	2052.2	2053.1
	+Project	2052.0 (+3.2)	2053.7 (+2.2)	2054.3 (+1.6)
Volume (af)	Baseline	23,404	47,536	54,724
	+Project	45,746 (+22,342)	59,664 (+12,128)	65,204 (+10,480)
Area (acres)	Baseline	1717	2328	2474
	+Project	2290 (+572)	2568 (+240)	2669 (+195)

Median concentrations of TDS, total N, total P and chlorophyll-a under the different hydrologic scenarios and levels of treatment are summarized in Table 25. As evident in the CDFs, the level of treatment of the supplemental water substantially affects the resulting water quality in the lake. Treated effluent with nutrient removal (Alternative 1), without additional treatment, offsets or other strategies, is predicted to have significant negative impacts to water quality in the lake, nearly doubling median concentrations of total P and total N, and increasing median chlorophyll-a concentrations by >5x relative to levels predicted for the natural (baseline) scenario (Table 25). Further advanced treatment of effluent (Alternatives 2 and 3), however, yielded predicted water quality broadly similar to or slightly better than the baseline case (Table 25).

Parameter	Scenario	5 th -Percentile	50 th -Percentile	95 th -Percentile
TDS (mg/L)	Baseline	250	198	175
	Alternative 1	478	358	293
	Alternative 2	300	225	187
	Alternative 3	241	180	155
Total P (mg/L)	Baseline	0.055	0.050	0.045
	Alternative 1	0.109	0.094	0.088
	Alternative 2	0.054	0.052	0.052
	Alternative 3	0.046	0.044	0.045
Total N (mg/L)	Baseline	1.22	1.11	1.06
	Alternative 1	2.17	1.96	1.85
	Alternative 2	1.21	1.20	1.20
	Alternative 3	1.05	1.05	1.05
Chlorophyll-a (µg/L)	Baseline	6.2	6.9	7.0
	Alternative 1	36.1	35.6	36.5
	Alternative 2	9.7	11.9	13.7
	Alternative 3	5.4	7.3	9.4

Summary

Simulations for 2009-2019 were extended to 2050 to evaluate possible long-term conditions in the lake under natural hydrologic variability with and without supplemental water from

Replenish Big Bear. Three hydrologic scenarios representing the 5th-, 50th- and 95th-percentile 30 year average annual flow records were used for predictions of future conditions in the lake. The 5th-percentile corresponded to an average inflow rate of 8,646 af/yr and represents extended drought, while the 50th-percentile (median) corresponded to intervals of both high runoff and drought comparable to 2009-2019 (average annual inflow of 10,595 af/yr), and the 95th-percentile represented a period of protracted above average rainfall and runoff (average annual inflow of 12,225 af/yr).

Supplementation with Replenish Big Bear was predicted to influence long-term (2009-2050) conditions in the lake which varied under the 3 hydrologic scenarios. Under the 50th-percentile hydrologic scenario, Replenish Big Bear was predicted to increase average lake level by 1.5 m, lake volume by nearly 13,000 af, and lake area by 260 acres relative to the predicted long-term baseline (no-project) condition. Water quality varied with level of effluent treatment, with Alternative 1 nearly doubling predicted long-term average concentrations of TDS, total P and total N and quadrupling average predicted chlorophyll-a levels. Long-term simulations indicate slight increases in average TDS, total P and total N and modest increase in chlorophyll-a for Alternative 2, and generally slight reductions or no significant change in concentrations with Alternative 3. Supplementation was predicted to have more substantial effects under the 5th-percentile hydrologic (drought) scenario, providing an average increase in lake level of 3.4 m, increase in volume of 16,104 af, and an additional average 638 surface acres (about 40% increase) relative to baseline. As with the 50th-percentile hydrologic scenario, supplementation with Alternative 1 effluent substantially degraded lake water quality, while further treatment as provided in Alternatives 2 and 3 yielded comparable or slightly improved water quality in the lake. Effects of Replenish Big Bear were more modest at the 95th-percentile runoff scenario, when supplementation is less important, owing to the lower overall contributions of water and TDS and nutrients relative to the watershed.

VI. ROUTING OF SUPPLEMENTAL WATER THROUGH STANFIELD MARSH

Simulations involved the delivery of Replenish Big Bear project water through Stanfield Marsh and into the main body of the lake. Wetlands are often very good at improving water quality by filtering and settling out of particulate matter, biological uptake of dissolved forms of nutrients, and under favorable conditions also denitrification and loss of $\text{NO}_3\text{-N}$ to the atmosphere. Stanfield Marsh was predicted to be an effective sink for total P in supplemental water with Treatment Alternatives 1 and 2 but was a modest source of total P for Alternative 3 water (Figure 43, Table 26).

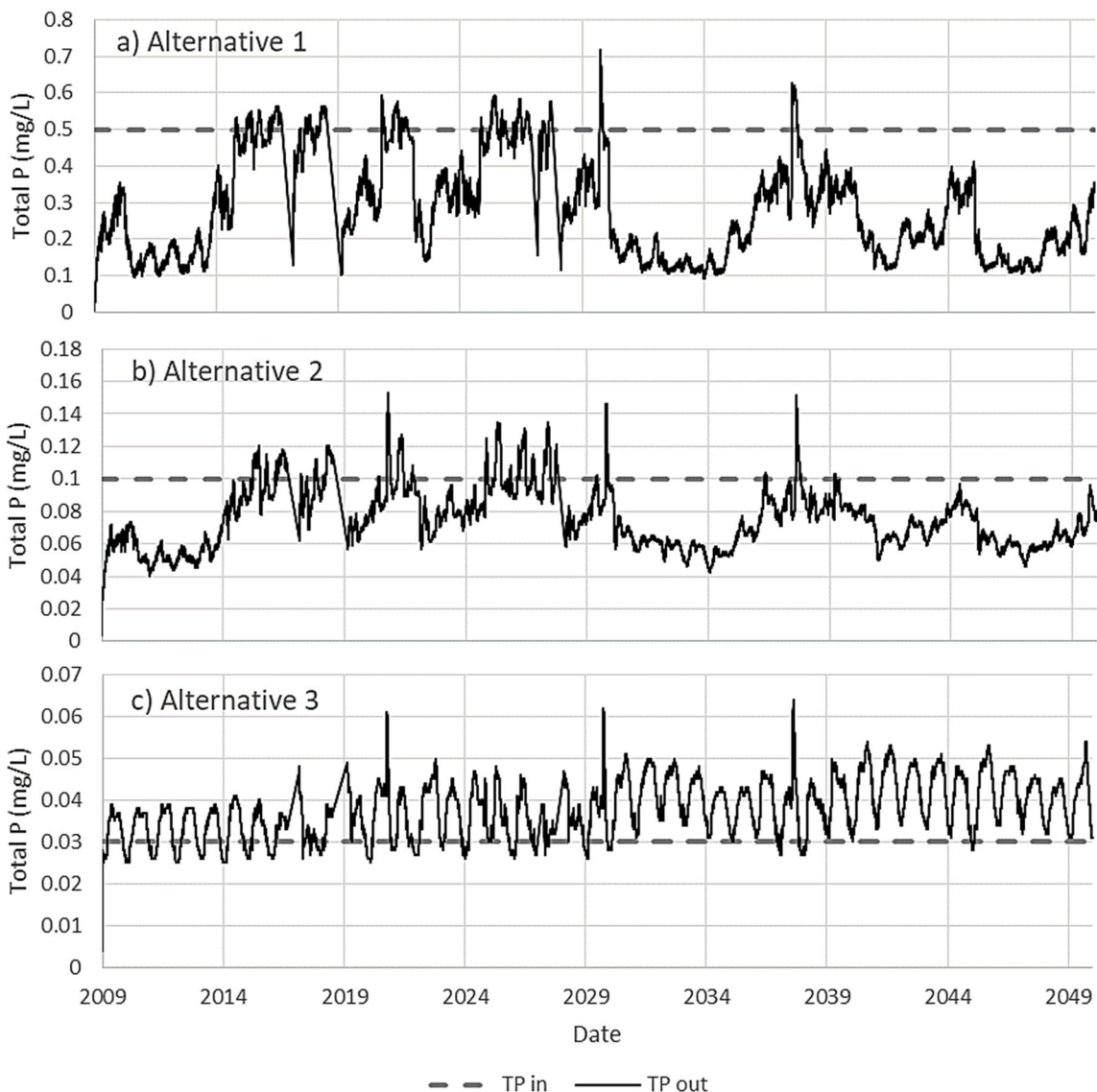

Figure 43. Total P concentrations into and out of Stanfield Marsh: a) Alternative 1, b) Alternative 2, and c) Alternative 3.

Final Report

Interestingly, the marsh was predicted to be a net source of N for all 3 treatment scenarios; the basis for this is not entirely clear at this time, but sediment mineralization and potentially some N₂-fixation may be occurring during periods of intense primary production that could increase the total N concentration. Stabilization of the water level within the marsh through some hydraulic control would presumably increase nutrient retention and could promote denitrification, although additional work is needed to understand the dynamics within the Marsh, especially given natural variations in lake levels and intervals of wetting and desiccation.

	Alternative 1		Alternative 2		Alternative 3	
	% Removal	kg/yr	% Removal	kg/yr	% Removal	kg/yr
Total P	14.8	175	8.4	20	-10.3	-7
Total N	-22.5	-1174	-17.0	-442	-19.0	-270

Summary

Simulations indicate net removal of total P from Alternative 1 and Alternative 2 effluents during flow through Stanfield Marsh, while the Marsh was predicted to be a modest source of total P to Alternative 3 water with very low influent concentrations. Interestingly, the Marsh was predicted to be a source of total N across all levels of treatment, due presumably to sediment decay, some N₂-fixation and subsequent decay in response high PO₄-P concentrations and high TN:TP ratios in the effluent. Further work is needed, however, to better understand the role of the Marsh as a net sink and/or source for nutrients.

VII. SUMMARY

Lake conditions and water quality in Big Bear Lake varied significantly over 2009-2019, with wide natural variations in lake level, volume and surface area, as well as concentrations of TDS, nutrients and chlorophyll-a. Statistical, machine learning and hypolimnetic mass balance analyses provided valuable new information about water quality in Big Bear Lake, while CE-QUAL-W2 was able to reproduce observed trends in lake conditions. Supplementation of natural runoff with Replenish Big Bear water significantly increased lake levels, volumes and surface areas, especially during periods of drought, with resulting recreational, aesthetic, community and related benefits. The level of treatment had dramatic effects on water quality, however. Nutrient removal (Alternative 1) was not sufficient to protect water quality in Big Bear Lake, although nutrient removal with further treatment (Alternatives 2 and 3) was predicted to yield water quality comparable to or slightly improved relative to baseline conditions.

VIII. REFERENCES

- Ahmed, U., R. Mumtaz, H. Anwar, A.A. Shah, R. Irfan and J. Garcia-Nieto. 2019. Efficient water quality prediction using supervised machine learning. *Water* 11:2210-2214
- Anderson, M. and K. Dyal. 2003. *Sediment Characterization and Internal Nutrient Loading: Big Bear Lake, CA*. Final Report. Riverside, CA: University of California, Riverside.
- Chou, J.-S., C.-C. Ho and H.-S. Hoang. 2018. Determining quality of water in reservoir using machine learning. *Ecol. Info.* 44:57-75.
- Cooke, G.D, E.B. Welch, S. Peterson and S.A. Nichols. 2005. *Restoration and Management of Lakes and Reservoirs*. 3rd ed. CRC Press. 616 pp.
- Fugro Pelagos In. 2006. Multibeam Hydrographic Survey Big Bear Lake, California. 69 pp.
- Harmel, R.D, R.J. Cooper, R.M. Slade, R.L. Haney and J.G. Arnold. 2006. Cumulative uncertainty in measured streamflow and water quality data for small watersheds. *Trans. ASABE* 49:689-71-.
- Jones, R.C. 1984. Application of a primary production model to epiphytic algae in a shallow, eutrophic lake. *Ecol.* 65:1895-1903.
- Kirby, M.E., Lund, S.P., Patterson, W.P., Anderson, M.A., Bird, B.W., Ivanovici, L., Monarrez, P. and Nielsen, S. 2010. A Holocene record of Pacific Decadal Oscillation (PDO)-related hydrologic variability in Southern California (Lake Elsinore, CA), *J. Paleolimnology*, 44:819-839.
- Mueller, A.C. and S. Guido. 2017. *Introduction to Machine Learning with Python: A Guide for Data Scientists*. O'Reilly Media, Sebastopol, CA. 525 pp.
- Park, Y, K.H. Cho, J. Park, S.M. Cha and J.H. Kim. 2015. Development of early-warning protocol for predicting chlorophyll-a concentrations using machine learning models in freshwater and estuarine reservoirs, Korea. *Sci. Total Environ.* 502:31-41.
- Santa Ana Water Board. 2005. *Staff Report on the Nutrient Total Maximum Daily Loads for Big Bear Lake*. California Regional Water Quality Control Board Santa Ana Region. 105 pp. + Appendices.
- Tetra Tech, Inc. 2004. *Final Big Bear Lake WASP model calibration report*. June 30.
- USGS. 2013. *Macrophyte and pH Buffering Updates to the Klamath River Water-Quality Model Upstream of Keno Dam, Oregon*. Sci. Invest. Rep. 2013-5016. 52 pp.
- Wells, S.A. 2018. *W2 Version 4.1 Release Notes*. Portland State University, Portland, OR. 114 pp.
- Wells, S.A. 2019. *CE-QUAL-W2: A Two-Dimensional, Laterally Averaged, Hydrodynamic and Water Quality Model, Version 4.2. Part 3 Input and Output Files. User Manual*. 415 pp.

Wetzel RG. 1984. Detrital dissolved and particulate organic carbon functions in aquatic ecosystems. *Bull. Mar. Sci.* 35:503–509.

White, J.D., S.J. Prochnow, C.T. Filstrup, J.T. Scott, B.W. Byars and L. Zygo-Flynn. 2010. A combined watershed-water quality modeling analysis of the Lake Waco reservoir: 1. Calibration and confirmation of predicted water quality. *Lake Reserv. Manage.* 26:147-158.

WSC. 2020a. *Tech Memo: Big Bear Lake Water Quality Baseline Assessment*. Water Systems Consulting, Inc. 20 pp.

WSC. 2020b. *Replenish Big Bear Treatment Process Alternatives Technical Memorandum*. Water Systems Consulting, Inc. February 2020.

Big Bear Area Regional Wastewater Agency

Replenish Big Bear

Antidegradation Analysis for Proposed Discharges to Stanfield Marsh/Big Bear Lake and Shay Pond

APPENDIX C: REPLENISH BIG BEAR: MODELING OF HIGHER FLOWS AND WITH ZERO TP LOAD

REPLENISH BIG BEAR: MODELING OF HIGHER FLOWS AND WITH ZERO TP LOAD

Michael A. Anderson, Ph.D.
Coeur d'Alene, ID

February 24, 2022

Acknowledgement of Credit

This report is financed under the Water Quality, Supply and Infrastructure Improvement Act of 2014, administered by State of California, Department of Water Resources.

Introduction

It was previously noted that water quality was predicted to vary markedly with the level of treatment of added Replenish Big Bear (RBB) recycled water, with Alternative 1 (TIN and TP removal) significantly degrading water quality in Big Bear Lake relative to predicted baseline conditions, while Alternative 2 (70% RO) modestly increased average predicted concentrations of TN, TP and chlorophyll-a, and Alternative 3 (100% RO) was predicted to slightly improve average water quality for the 2009-2019 period (Anderson, 2021, Table 22). Long-term simulations for different hydrologic scenarios yielded similar results, with 100% RO yielding predicted water quality typically comparable to baseline conditions. Notwithstanding, some subtle differences were observed between predicted median baseline concentrations and those for Alternative 3 which assumed steady annual flows of 1920 af/yr of 100% RO water (Anderson, 2021, Table 25).

Recent engineering work indicates that slightly higher inflows, up to 2210 af/yr, can be attained by the Replenish Big Bear project by employing additional brine minimization technology (Table 1). Note that a portion of the water produced by RBB may be discharged to Shay Pond and the earlier “Alternative 3” scenario had excluded those flows (up to 80 af/yr) from the analysis. However, to be conservative for permitting purposes, this analysis is based on discharging all of the recycled water produced to the Lake.

Table 1. Initial and recently updated Replenish Big Bear (RBB) flow projections.		
Scenario	Annual RBB Inflow (af)	Daily RBB Inflow (MGD)
Baseline	0	0
Alternative 3 ^(a)	1920	1.71
High Flow (99% recovery) ^(b)	2210	1.57 – 2.18
Mid Flow (90% recovery) ^(b)	2009	1.42 – 1.98
Notes:		
^(a) Alternative 3 was assessed in the 2021 Lake Analysis and assumed that of the total Replenish Big Bear effluent contribution considered in the Lake Analysis (i.e., 2,000 AFY), 80 AFY would be delivered to Shay Pond. Therefore, only 1,920 AFY would be discharged to the Lake.		
^(b) The updated model analysis assumed that no discharge to Shay Pond would occur and all recycled water would be discharged to the Lake under two different total recovery rates scenarios.		

Moreover, deliveries are expected to vary seasonally (Fig 1), thus varying from the earlier “Alternative 3” scenario that assumed uniform flows of 1.71 MGD throughout the year. Inflows to the WWTP are lower in the summer months due to reduced inflow.

Since the Replenish Big Bear project does not have a waste load allocation for total P (TP) in the current TMDL, it is proposing to offset the TP load in the project inflows delivered to Big Bear Lake. While RO is extremely effective at removing dissolved and particulate substances, there nonetheless is a small quantity of TP that is expected to evade treatment (the projected RO effluent concentration is 0.03 mg/L, principally as o-PO₄-P). Elimination of all TP through the treatment process is not practicable, so removal of an equivalent load of TP (up to 200 lbs/yr) from elsewhere in the lake or watershed will be necessary.

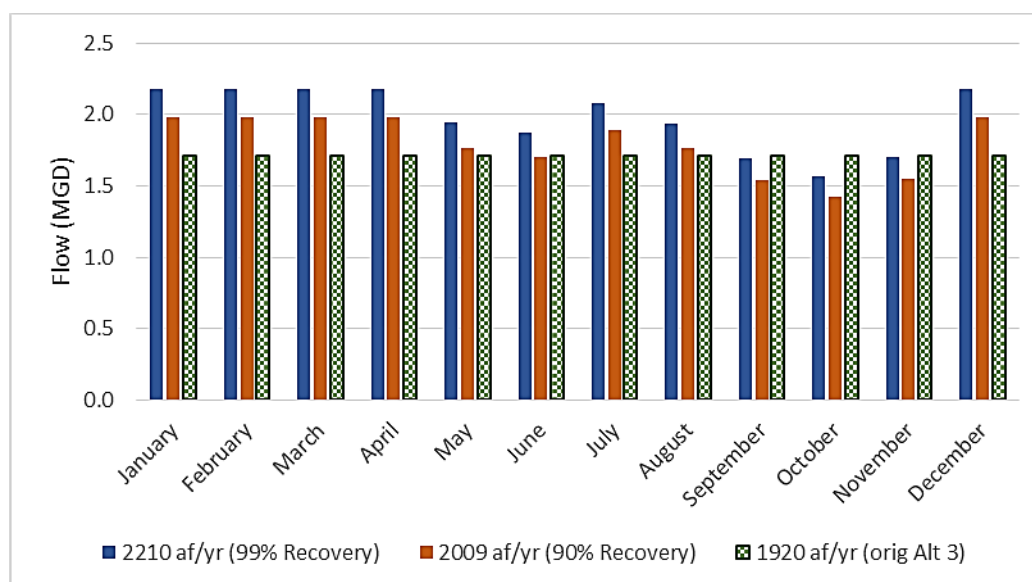

Fig. 1. Monthly flow rates (projected 2040) for Replenish Big Bear under three project inflow scenarios.

In light of these factors, further modeling was conducted to evaluate predicted water quality under these operational scenarios (increased and time-varying flows, with and without TP offset) for comparison with the previously predicted baseline condition and Alternative 3 scenario. Given the complexity of nutrient budgets of lakes, array of possible offset strategies, and equivalence of a given form of nutrient irrespective of its particular origin, TP offset will be modeled as equivalent to 0 influent concentration. This is an approximation that holds when considering whole-lake nutrient budget, but is nonetheless a simplification; depending upon details of offset, hydrodynamic considerations and other factors, some modest lateral gradients in water quality may result. The 50th percentile hydrologic scenario for 2009-2050 was used in this analysis, noting that it includes a wide array of runoff conditions, included extended drought and as well as periods of high runoff. All other hydrologic, meteorological, biological, chemical and sedimentological factors, variables and conditions were identical to those used in prior simulations of long-term future conditions (Anderson, 2021).

Results

Long-term averaged predicted concentrations of TDS, TIN, total P, total N and chlorophyll-a were lower with addition of RBB water compared with predicted baseline conditions (no supplementation) (Table 2). For reference, TMDL target values are included in the table. Focusing on chlorophyll-a as the key response target, baseline conditions were predicted to yield growing-season average chlorophyll-a concentration that slightly exceeded (by 0.1 $\mu\text{g/L}$) the TMDL target value of 14 $\mu\text{g/L}$, while Alternative 3 matched the target value, and larger inputs of RBB inflow that varied seasonally (Fig. 1) yielded values below baseline and TMDL target values (Table 2). Zeroing out the load of TP in RBB inflow yielded further reductions in chlorophyll-a; larger inflow volumes with reduced summer flows and no net TP loading were predicted to yield growing season average chlorophyll-a concentrations as low as 9.5 - 10.2 $\mu\text{g/L}$, significantly below predicted baseline and TMDL concentrations (Table 2).

Table 2. Long-term average predicted concentrations of total P, total N and chlorophyll-a in Big Bear Lake under different operational scenarios (total P and total N expressed as annual average concentrations; chlorophyll-a shown as growing season average concentrations).

Operational Scenario (all at 50th % hydrology)	TDS (mg/L)	TIN (mg/L)	Total P (µg/L)	Total N (mg/L)	Chlorophyll-a (µg/L)
Baseline	195	0.069	47.7	1.15	14.1
Alternative 3 (1920 af)	182	0.052	43.3	1.07	14.0
2210 af (99% recovery)	179	0.045	42.3	1.04	13.1
2009 af (90% recovery)	180	0.041	43.4	1.06	12.9
2210 af + 0 total P	179	0.072	39.9	1.00	10.2
2009 af + 0 total P	180	0.040	40.9	1.00	9.5
TMDL target			35.0		14.0

Supplementation with RBB inflow also lowered concentrations of total P and total N relative to predicted baseline levels (Table 2). This is consistent with the reduced concentrations of total N and total P (and most dissolved forms of N and P) in RO water relative to watershed runoff concentrations (Anderson, 2021, Table 20), with concentrations projected to be only 40% - 80% of average watershed runoff concentrations (Anderson, 2021, Table 21). Interestingly, zeroing out the influent TP concentration not only lowered the predicted average total P concentration but also reduced the predicted total N concentrations, highlighting the complex biogeochemical coupling of these two key nutrients. While it is important to recognize the uncertainty in model predictions, it is nonetheless noteworthy that revised project flows, with varying seasonal flow and TP offset, yielded average chlorophyll-a concentrations significantly below baseline and TMDL values and also yielded long-term average TN concentrations approaching or reaching 1 mg/L, which is being considered by the Regional Water Board. Predicted long-term average TP concentrations remained above the TMDL target, but were nonetheless meaningfully lower than the predicted baseline level (Table 2). Average TDS and TIN concentrations were also lower than predicted baseline conditions (with exception of 2210 af + 0 TP, where a period of higher NO₃-N was predicted).

Inter-annual differences in water quality are nonetheless expected to persist. Cumulative distributions functions (CDFs) highlight the predicted wide range in annual and growing season average concentrations (Fig. 2). While addition of RBB inflow shifted CDFs to lower annual average total P and total N concentrations and growing season average chlorophyll-a concentrations, wide ranges in predicted concentrations remained in place (Fig. 2). Thus, the growing season average chlorophyll-a target of 14 µg/L was predicted to be exceeded about 53% of the time under baseline conditions, and exceeded about 41% and 31% of the time with RBB inflows of 2210 af/yr without and with TP offset, respectively (Fig. 2c; Table 3). Results for all scenarios are summarized in Table 3.

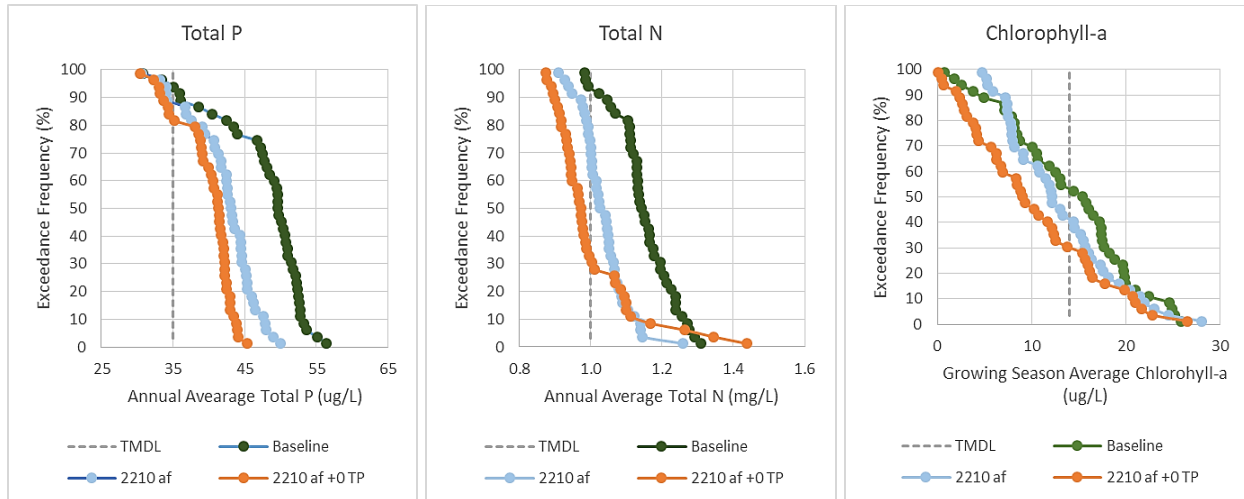

Fig. 2. Cumulative distribution functions for predicted annual total P and total N concentrations and growing season average chlorophyll-a concentrations for baseline condition and with 2210 af RBB inflow with and without TP offset.

Table 3. Predicted frequency of exceeding TMDL target under baseline conditions and different RBB inflow and TP offset scenarios (annual average or growing season average basis). Observed annual exceedance frequencies for 2009-19 period shown in parentheses under Baseline.

Variable	Baseline	1920 af	2210 af	2210 af+0 TP	2009 af	2009 af+0 TP
Total P	94 % (100%)	87 %	87 %	82 %	91 %	90 %
Total N ^a	91 % (na)	72 %	72 %	30 %	80 %	55 %
Chlorophyll-a	53 % (55%)	51 %	41 %	31 %	40 %	22 %

^apossible TMDL target

References

Anderson, M.A. 2021. *Big Bear Lake Analysis: Replenish Big Bear*. Final Report. 65 pp.

Big Bear Area Regional Wastewater Agency

Replenish Big Bear

Antidegradation Analysis for Proposed Discharges to Stanfield Marsh/Big Bear Lake and Shay Pond

APPENDIX D: SECONDARY EFFLUENT, BIG BEAR LAKE, AND SHAY POND WATER QUALITY DATA FOR ANTIDEGRADATION ANALYSIS

Location	PTP	Analyte	Qualifier	Result	Units	RL	MDL	Analytical Method	Sample Date	Analysis Date	Excluded in Average Calculation?
Big Bear Lake		Total Nitrogen	J-Flag	0.87	mg/L			Calculated	12/2/2021	12/3/2021	No
Shay Pond		Total Nitrogen	=	1.2	mg/L			Calculated	11/17/2021	11/22/2021	No
Big Bear Lake		Total Kjeldahl Nitrogen	J-Flag	0.87	mg/L	1		EPA 351.2	12/2/2021	12/3/2021	No
Shay Pond		Total Kjeldahl Nitrogen	<	ND	mg/L	1		EPA 351.2	11/17/2021	11/22/2021	Yes
Big Bear Lake		Total Filterable Residue/TDS	=	320	mg/L	5		SM 2540C	12/2/2021	12/10/2021	No
Shay Pond		Total Filterable Residue/TDS	=	320	mg/L	5		SM 2540C	11/17/2021	11/29/2021	No
Secondary Effluent		TDS	=	451	mg/L				1/14/2021		No
Secondary Effluent		TDS	=	428	mg/L				2/3/2021		No
Secondary Effluent		TDS	=	398	mg/L				3/3/2021		No
Secondary Effluent		TDS	=	415	mg/L				4/14/2021		No
Secondary Effluent		TDS	=	438	mg/L				5/19/2021		No
Secondary Effluent		TDS	=	447	mg/L				6/16/2021		No
Secondary Effluent		TDS	=	460	mg/L				7/21/2021		No
Secondary Effluent		TDS	=	453	mg/L				8/11/2021		No
Secondary Effluent		TDS	=	475	mg/L				9/1/2021		No
Secondary Effluent		TDS	=	461	mg/L				10/6/2021		No
Secondary Effluent		TDS	=	450	mg/L				11/17/2021		No
Secondary Effluent		TDS	=	411	mg/L				12/8/2021		No
Secondary Effluent		Sulfate	=	35	mg/L	0.5	0.14	EPA 300.0	11/18/2021	11/18/2021	No
Big Bear Lake		Sulfate	=	18	mg/L	0.5		EPA 300.0	12/2/2021	12/2/2021	No
Shay Pond		Sulfate	=	23	mg/L	0.5		EPA 300.0	11/17/2021	11/18/2021	No
Secondary Effluent		Sulfate	=	41	mg/L				1/6/2021		No
Secondary Effluent		Sulfate	=	40	mg/L				1/20/2021		No
Secondary Effluent		Sulfate	=	41	mg/L				2/17/2021		No
Secondary Effluent		Sulfate	=	42	mg/L				2/24/2021		No
Secondary Effluent		Sulfate	=	42	mg/L				3/3/2021		No
Secondary Effluent		Sulfate	=	41	mg/L				3/10/2021		No
Secondary Effluent		Sulfate	=	41	mg/L				4/7/2021		No
Secondary Effluent		Sulfate	=	42	mg/L				4/14/2021		No
Secondary Effluent		Sulfate	=	41	mg/L				5/27/2021		No
Secondary Effluent		Sulfate	=	44	mg/L				6/9/2021		No
Secondary Effluent		Sulfate	=	43	mg/L				6/22/2021		No
Secondary Effluent		Sulfate	=	37	mg/L				7/21/2021		No
Secondary Effluent		Sulfate	=	38	mg/L				8/25/2021		No
Secondary Effluent		Sulfate	=	40	mg/L				9/8/2021		No
Secondary Effluent		Sulfate	=	42	mg/L				10/6/2021		No
Secondary Effluent		Sulfate	=	43	mg/L				10/20/2021		No
Secondary Effluent		Sulfate	=	40	mg/L				11/3/2021		No
Secondary Effluent		Sulfate	=	35	mg/L				11/17/2021		No
Secondary Effluent		Sulfate	=	43	mg/L				12/1/2021		No
Secondary Effluent		Specific Conductance (E.C.)	=	755	µmhos/cm			SM 2510B	11/18/2021		No
Big Bear Lake		Specific Conductance (E.C.)	=	470	µmhos/cm	2		SM 2510B	12/2/2021	12/3/2021	No
Shay Pond		Specific Conductance (E.C.)	=	450	µmhos/cm	2		SM 2510B	11/17/2021	11/18/2021	No
Big Bear Lake		Sodium	=	33	mg/L	1			12/2/2021		No
Secondary Effluent		Nitrite as N (NO2-N)	<	ND	mg/L	0.4	0.17	EPA 300.0	11/20/2019		Yes
Big Bear Lake		Nitrite as N (NO2-N)	<	ND	mg/L	0.4		EPA 300.0	12/2/2021	12/2/2021	Yes
Shay Pond		Nitrite as N (NO2-N)	<	ND	mg/L	0.4		EPA 300.0	11/17/2021	11/18/2021	Yes

Location	PTP	Analyte	Qualifier	Result	Units	RL	MDL	Analytical Method	Sample Date	Analysis Date	Excluded in Average Calculation?
Secondary Effluent		Nitrate as N (NO3-N)	=	1.3	mg/L	0.4	0.12	EPA 300.0	11/20/2019		No
Big Bear Lake		Nitrate as N (NO3-N)	<	ND	mg/L	0.4		EPA 300.0	12/2/2021	12/2/2021	Yes
Shay Pond		Nitrate as N (NO3-N)	=	1.2	mg/L	0.4		EPA 300.0	11/17/2021	11/18/2021	No
Big Bear Lake		Nitrate + Nitrite (as N)	<	ND	mg/L	0.4		EPA 300.0	12/2/2021	12/2/2021	Yes
Shay Pond		Nitrate + Nitrite (as N)	=	1.3	mg/L	0.4		EPA 300.0	11/17/2021	11/18/2021	No
Secondary Effluent		Methylmercury, Dissolved	=	0.13	ng/L	0.05		EPA 1630 filtrate	6/18/2020	6/25/2020	No
Secondary Effluent		Methylmercury	=	0.18	ng/L	0.05		EPA 1630	6/18/2020	6/25/2020	No
Secondary Effluent		Mercury, Dissolved	<	ND	µg/L	0.0005		EPA 1631E filtra	6/18/2020	6/24/2020	Yes
Secondary Effluent	8	Mercury	<	ND	µg/L	0.2	0.15	EPA 245.1	12/1/2016		Yes
Secondary Effluent	8	Mercury	<	ND	µg/L	0.2	0.15	EPA 245.1	11/29/2017		Yes
Secondary Effluent	8	Mercury	<	ND	µg/L	0.2	0.05	EPA 245.1	12/5/2018		Yes
Secondary Effluent	8	Mercury	<	ND	µg/L	0.2	0.15	EPA 245.1	11/20/2019		Yes
Secondary Effluent	8	Mercury	<	ND	µg/L	0.2	0.15	EPA 245.1	12/18/2019		Yes
Secondary Effluent	8	Mercury	=	0.00076	µg/L	0.0005		EPA 1631E	6/18/2020	6/24/2020	No
Secondary Effluent	8	Mercury	<	ND	µg/L	0.2	0.15	EPA 245.1	12/2/2020		Yes
Secondary Effluent	8	Mercury	<	ND	µg/L	1	0.15	EPA 245.1	11/18/2021	12/13/2021	Yes
Big Bear Lake	8	Mercury	<	ND	µg/L	1		EPA 200.8	12/2/2021	12/8/2021	Yes
Big Bear Lake	8	Mercury	=	0.27	µg/L	0.2	0.15	EPA 245.1	12/2/2021	12/9/2021	No
Shay Pond	8	Mercury	<	ND	µg/L	1		EPA 200.8	11/17/2021	11/30/2021	Yes
Shay Pond	8	Mercury	<	ND	µg/L	0.2	0.15	EPA 245.1	11/17/2021	11/30/2021	Yes
Secondary Effluent		MBAS (LAS Mole. Wt 340.0)	<	ND	mg/L	0.1	0.047	SM 5540C	11/20/2019		Yes
Secondary Effluent		MBAS (LAS Mole. Wt 340.0)	=	0.14	mg/L	0.1	0.047	SM 5540C	11/18/2021	11/18/2021	No
Big Bear Lake		MBAS (LAS Mole. Wt 340.0)	J-Flag	0.058	mg/L	0.1		SM 5540C	12/2/2021	12/2/2021	No
Shay Pond		MBAS (LAS Mole. Wt 340.0)	<	ND	mg/L	0.1		SM 5540C	11/17/2021	11/18/2021	Yes
Secondary Effluent	7	Lead	<	ND	µg/L	5	0.51	EPA 200.8	12/1/2016		Yes
Secondary Effluent	7	Lead	<	ND	µg/L	5	0.51	EPA 200.8	11/29/2017		Yes
Secondary Effluent	7	Lead	<	ND	µg/L	5	0.51	EPA 200.8	12/5/2018		Yes
Secondary Effluent	7	Lead	<	ND	µg/L	5	0.51	EPA 200.8	12/12/2018		Yes
Secondary Effluent	7	Lead	=	0.76	µg/L	5	0.51	EPA 200.8	11/20/2019		No
Secondary Effluent	7	Lead	<	ND	µg/L	5	0.51	EPA 200.8	12/18/2019		Yes
Secondary Effluent	7	Lead	<	ND	µg/L	5	0.51	EPA 200.8	12/2/2020		Yes
Secondary Effluent	7	Lead	J-Flag	1.8	µg/L	5	0.51	EPA 200.8	11/18/2021	11/24/2021	No
Big Bear Lake	7	Lead	J-Flag	1.8	µg/L	5		EPA 200.8	12/2/2021	12/9/2021	No
Shay Pond	7	Lead	J-Flag	1.4	µg/L	5		EPA 200.8	11/17/2021	11/24/2021	No
Secondary Effluent		Hardness, Total (as CaCO3)	=	270	mg/L			Calculated	11/20/2019		No
Secondary Effluent		Hardness, Total (as CaCO3)	=	260	mg/L	6.6		Calculated	11/18/2021	11/24/2021	No
Big Bear Lake		Hardness, Total (as CaCO3)	=	180	mg/L	6.6		Calculated	12/2/2021	12/9/2021	No
Shay Pond		Hardness, Total (as CaCO3)	=	180	mg/L	6.6		Calculated	11/17/2021	12/1/2021	No
Secondary Effluent		Fluoride	=	0.3	mg/L	0.1	0.026	EPA 300.0	11/20/2019		No
Secondary Effluent		Fluoride	=	0.52	mg/L	0.1	0.026	EPA 300.0	11/18/2021	11/18/2021	No
Big Bear Lake		Fluoride	=	0.41	mg/L	0.1		EPA 300.0	12/2/2021	12/2/2021	No
Shay Pond		Fluoride	=	1.2	mg/L	0.1		EPA 300.0	11/17/2021	11/18/2021	No
Secondary Effluent	6	Copper	<	ND	µg/L	50	6.5	EPA 200.7	12/1/2016		Yes
Secondary Effluent	6	Copper	<	ND	µg/L	50	6.5	EPA 200.7	11/29/2017		Yes
Secondary Effluent	6	Copper	<	ND	µg/L	50	6.5	EPA 200.7	12/5/2018		Yes
Secondary Effluent	6	Copper	<	ND	µg/L	50	6.5	EPA 200.7	12/12/2018		Yes
Secondary Effluent	6	Copper	<	ND	µg/L	50	6.5	EPA 200.7	11/20/2019		Yes

Location	PTP	Analyte	Qualifier	Result	Units	RL	MDL	Analytical Method	Sample Date	Analysis Date	Excluded in Average Calculation?
Secondary Effluent	6	Copper	<	ND	µg/L	50	6.5	EPA 200.7	12/18/2019		Yes
Secondary Effluent	6	Copper	<	ND	µg/L	50	6.5	EPA 200.7	12/2/2020		Yes
Secondary Effluent	6	Copper	J-Flag	14	µg/L	50	6.5	EPA 200.7	11/18/2021	11/23/2021	No
Big Bear Lake	6	Copper	<	ND	µg/L	50		EPA 200.7	12/2/2021	12/10/2021	Yes
Shay Pond	6	Copper	J-Flag	31	µg/L	50		EPA 200.7	11/17/2021	11/23/2021	No
Secondary Effluent		Chloride	=	53	mg/L	1	0.075	EPA 300.0	11/18/2021	11/18/2021	No
Big Bear Lake		Chloride	=	26	mg/L	1		EPA 300.0	12/2/2021	12/2/2021	No
Shay Pond		Chloride	=	7.6	mg/L	1		EPA 300.0	11/17/2021	11/18/2021	No
Secondary Effluent		Chloride	=	62	mg/L				1/6/2021		No
Secondary Effluent		Chloride	=	58	mg/L				1/20/2021		No
Secondary Effluent		Chloride	=	60	mg/L				2/17/2021		No
Secondary Effluent		Chloride	=	60	mg/L				2/24/2021		No
Secondary Effluent		Chloride	=	59	mg/L				3/3/2021		No
Secondary Effluent		Chloride	=	59	mg/L				3/10/2021		No
Secondary Effluent		Chloride	=	58	mg/L				4/7/2021		No
Secondary Effluent		Chloride	=	60	mg/L				4/14/2021		No
Secondary Effluent		Chloride	=	63	mg/L				5/19/2021		No
Secondary Effluent		Chloride	=	59	mg/L				5/27/2021		No
Secondary Effluent		Chloride	=	60	mg/L				6/9/2021		No
Secondary Effluent		Chloride	=	60	mg/L				6/22/2021		No
Secondary Effluent		Chloride	=	55	mg/L				7/14/2021		No
Secondary Effluent		Chloride	=	55	mg/L				7/21/2021		No
Secondary Effluent		Chloride	=	58	mg/L				8/18/2021		No
Secondary Effluent		Chloride	=	58	mg/L				8/25/2021		No
Secondary Effluent		Chloride	=	58	mg/L				9/8/2021		No
Secondary Effluent		Chloride	=	57	mg/L				9/15/2021		No
Secondary Effluent		Chloride	=	56	mg/L				10/6/2021		No
Secondary Effluent		Chloride	=	62	mg/L				10/20/2021		No
Secondary Effluent		Chloride	=	59	mg/L				11/3/2021		No
Secondary Effluent		Chloride	=	53	mg/L				11/17/2021		No
Secondary Effluent		Chloride	=	59	mg/L				12/1/2021		No
Secondary Effluent		Chloride	=	57	mg/L				12/8/2021		No
Secondary Effluent	107	Chlordane	<	ND	µg/L	0.5	0.17	EPA 608	11/18/2021	12/13/2021	Yes
Big Bear Lake	107	Chlordane	<	ND	µg/L	0.1	0.034	EPA 608M	12/2/2021	12/10/2021	Yes
Shay Pond	107	Chlordane	<	ND	µg/L	0.5	0.17	EPA 608M	11/17/2021	11/24/2021	Yes
Secondary Effluent	4	Cadmium	<	ND	µg/L	1	0.11	EPA 200.8	12/1/2016		Yes
Secondary Effluent	4	Cadmium	<	ND	µg/L	1	0.11	EPA 200.8	11/29/2017		Yes
Secondary Effluent	4	Cadmium	<	ND	µg/L	1	0.11	EPA 200.8	12/5/2018		Yes
Secondary Effluent	4	Cadmium	<	ND	µg/L	1	0.11	EPA 200.8	12/12/2018		Yes
Secondary Effluent	4	Cadmium	<	ND	µg/L	1	0.11	EPA 200.8	11/20/2019		Yes
Secondary Effluent	4	Cadmium	<	ND	µg/L	1	0.11	EPA 200.8	12/18/2019		Yes
Secondary Effluent	4	Cadmium	<	ND	µg/L	1	0.11	EPA 200.8	12/2/2020		Yes
Secondary Effluent	4	Cadmium	<	ND	µg/L	1	0.11	EPA 200.8	11/18/2021	11/24/2021	Yes
Big Bear Lake	4	Cadmium	<	ND	µg/L	1		EPA 200.8	12/2/2021	12/9/2021	Yes
Shay Pond	4	Cadmium	<	ND	µg/L	1		EPA 200.8	11/17/2021	11/24/2021	Yes
Secondary Effluent		Boron	=	270	µg/L	100	32	EPA 200.7	11/20/2019		No
Secondary Effluent		Boron	=	260	µg/L	100	32	EPA 200.7	11/18/2021	11/23/2021	No

Location	PTP	Analyte	Qualifier	Result	Units	RL	MDL	Analytical Method	Sample Date	Analysis Date	Excluded in Average Calculation?
Big Bear Lake		Boron	J-Flag	54	µg/L	100		EPA 200.7	12/2/2021	12/10/2021	No
Shay Pond		Boron	J-Flag	59	µg/L	100		EPA 200.7	11/17/2021	11/23/2021	No
Secondary Effluent	125	Aroclor 1260	<	ND	µg/L	2.5	2.5	EPA 608	11/18/2021	12/13/2021	Yes
Big Bear Lake	125	Aroclor 1260	<	ND	µg/L	0.5	0.5	EPA 608M	12/2/2021	12/10/2021	Yes
Shay Pond	125	Aroclor 1260	<	ND	µg/L	2.5	2.5	EPA 608M	11/17/2021	11/24/2021	Yes
Secondary Effluent	124	Aroclor 1254	<	ND	µg/L	2.5	2.5	EPA 608	11/18/2021	12/13/2021	Yes
Big Bear Lake	124	Aroclor 1254	<	ND	µg/L	0.5	0.5	EPA 608M	12/2/2021	12/10/2021	Yes
Shay Pond	124	Aroclor 1254	<	ND	µg/L	2.5	2.5	EPA 608M	11/17/2021	11/24/2021	Yes
Secondary Effluent	123	Aroclor 1248	<	ND	µg/L	2.5	2.5	EPA 608	11/18/2021	12/13/2021	Yes
Big Bear Lake	123	Aroclor 1248	<	ND	µg/L	0.5	0.5	EPA 608M	12/2/2021	12/10/2021	Yes
Shay Pond	123	Aroclor 1248	<	ND	µg/L	2.5	2.5	EPA 608M	11/17/2021	11/24/2021	Yes
Secondary Effluent	122	Aroclor 1242	<	ND	µg/L	2.5	2.5	EPA 608	11/18/2021	12/13/2021	Yes
Big Bear Lake	122	Aroclor 1242	<	ND	µg/L	0.5	0.5	EPA 608M	12/2/2021	12/10/2021	Yes
Shay Pond	122	Aroclor 1242	<	ND	µg/L	2.5	2.5	EPA 608M	11/17/2021	11/24/2021	Yes
Secondary Effluent	121	Aroclor 1232	<	ND	µg/L	2.5	2.5	EPA 608	11/18/2021	12/13/2021	Yes
Big Bear Lake	121	Aroclor 1232	<	ND	µg/L	0.5	0.5	EPA 608M	12/2/2021	12/10/2021	Yes
Shay Pond	121	Aroclor 1232	<	ND	µg/L	2.5	2.5	EPA 608M	11/17/2021	11/24/2021	Yes
Secondary Effluent	120	Aroclor 1221	<	ND	µg/L	2.5	2.5	EPA 608	11/18/2021	12/13/2021	Yes
Big Bear Lake	120	Aroclor 1221	<	ND	µg/L	0.5	0.5	EPA 608M	12/2/2021	12/10/2021	Yes
Shay Pond	120	Aroclor 1221	<	ND	µg/L	2.5	2.5	EPA 608M	11/17/2021	11/24/2021	Yes
Secondary Effluent	119	Aroclor 1016	<	ND	µg/L	2.5	2.5	EPA 608	11/18/2021	12/13/2021	Yes
Big Bear Lake	119	Aroclor 1016	<	ND	µg/L	0.5	0.5	EPA 608M	12/2/2021	12/10/2021	Yes
Shay Pond	119	Aroclor 1016	<	ND	µg/L	2.5	2.5	EPA 608M	11/17/2021	11/24/2021	Yes
Secondary Effluent		Ammonia as N (NH3-N)	<	ND	mg/L				11/28/2018		Yes
Secondary Effluent		Ammonia as N (NH3-N)	<	ND	mg/L				12/12/2018		Yes
Secondary Effluent		Ammonia as N (NH3-N)	=	22	mg/L				1/2/2019		No
Secondary Effluent		Ammonia as N (NH3-N)	=	7.5	mg/L				1/16/2019		No
Secondary Effluent		Ammonia as N (NH3-N)	=	0.45	mg/L				2/6/2019		No
Secondary Effluent		Ammonia as N (NH3-N)	=	1.1	mg/L				2/13/2019		No
Secondary Effluent		Ammonia as N (NH3-N)	<	ND	mg/L				3/6/2019		Yes
Secondary Effluent		Ammonia as N (NH3-N)	=	0.26	mg/L				3/20/2019		No
Secondary Effluent		Ammonia as N (NH3-N)	=	0.27	mg/L				4/3/2019		No
Secondary Effluent		Ammonia as N (NH3-N)	<	ND	mg/L				4/17/2019		Yes
Secondary Effluent		Ammonia as N (NH3-N)	<	ND	mg/L				5/1/2019		Yes
Secondary Effluent		Ammonia as N (NH3-N)	=	3.2	mg/L				5/15/2019		No
Secondary Effluent		Ammonia as N (NH3-N)	=	0.39	mg/L				6/23/2019		No
Secondary Effluent		Ammonia as N (NH3-N)	=	1.6	mg/L				7/17/2019		No
Secondary Effluent		Ammonia as N (NH3-N)	=	3.1	mg/L				8/7/2019		No
Secondary Effluent		Ammonia as N (NH3-N)	=	1.4	mg/L				8/21/2019		No
Secondary Effluent		Ammonia as N (NH3-N)	=	6.6	mg/L				9/4/2019		No
Secondary Effluent		Ammonia as N (NH3-N)	<	ND	mg/L				9/18/2019		Yes
Secondary Effluent		Ammonia as N (NH3-N)	=	2.3	mg/L				10/23/2019		No
Secondary Effluent		Ammonia as N (NH3-N)	=	1.3	mg/L				11/6/2019		No
Secondary Effluent		Ammonia as N (NH3-N)	=	0.55	mg/L				11/20/2019		No
Secondary Effluent		Ammonia as N (NH3-N)	=	0.26	mg/L				12/4/2019		No
Secondary Effluent		Ammonia as N (NH3-N)	<	ND	mg/L				12/18/2019		Yes
Secondary Effluent		Ammonia as N (NH3-N)	=	1.2	mg/L				11/18/2021		No

Location	PTP	Analyte	Qualifier	Result	Units	RL	MDL	Analytical Method	Sample Date	Analysis Date	Excluded in Average Calculation?
Big Bear Lake		Ammonia as N (NH3-N)	J-Flag	0.29	mg/L	0.5		EPA 350.1	12/2/2021	12/16/2021	No
Shay Pond		Ammonia as N (NH3-N)	J-Flag	0.24	mg/L	0.5		EPA 350.1	11/17/2021	11/30/2021	No
Secondary Effluent		Aluminum	=	110	µg/L	50	14	EPA 200.7	11/20/2019		No
Secondary Effluent		Aluminum	=	250	µg/L	50	14	EPA 200.7	11/18/2021	11/23/2021	No
Big Bear Lake		Aluminum	=	58	µg/L	50		EPA 200.7	12/2/2021	12/10/2021	No
Shay Pond		Aluminum	=	120	µg/L	50		EPA 200.7	11/17/2021	11/23/2021	No
Secondary Effluent	108	4,4'-DDT	<	ND	µg/L	0.05	0.0052	EPA 608	11/18/2021	12/13/2021	Yes
Big Bear Lake	108	4,4'-DDT	<	ND	µg/L	0.01	0.001	EPA 608M	12/2/2021	12/10/2021	Yes
Shay Pond	108	4,4'-DDT	<	ND	µg/L	0.05	0.0052	EPA 608M	11/17/2021	11/24/2021	Yes

Big Bear Area Regional Wastewater Agency

Replenish Big Bear

Antidegradation Analysis for Proposed Discharges to Stanfield Marsh/Big Bear Lake and Shay Pond

APPENDIX E: BIG BEAR LAKE AMMONIA AND HARDNESS CALCULATIONS

Constituent: Ammonia as N
 Nutrient TMDL Data

Appendix E - Big Bear Lake Ammonia and Hardness Calculations

For this analysis, the lake-wide annual average was estimated by averaging the four station annual averages consistent with the Nutrient TMDL approach, which consist of averaging the photic and bottom samples for each sampling date.

	Station 1	Station 2	Station 6	Station 9	Lake Wide Annual Average
Min	0.015	0.010	0.010	0.010	0.013
Max	0.306	0.230	0.245	0.135	0.167
Average	0.087	0.072	0.056	0.035	0.063
Median	0.069	0.063	0.044	0.028	0.051

MonthYear	Station 1	Station 2	Station 6	Station 9	Lake Wide Annual Average
5/1/2009	0.19	0.161	0.084	0.035	0.118
6/30/2009	0.176	0.111	0.078	0.055	0.105
7/31/2009	0.112	0.109	0.045	0.041	0.077
8/31/2009	0.074	0.102	0.048	0.013	0.059
9/30/2009	0.032	0.037	0.028	0.035	0.033
10/31/2009	0.046	0.044	0.054	0.037	0.045
11/30/2009	0.062	0.046	0.077	0.03	0.054
6/30/2010	0.259	0.156	0.152	0.06	0.157
7/31/2010	0.276	0.104	0.071	0.02	0.118
8/31/2010	0.306	0.138	0.078	0.03	0.138
9/30/2010	0.042	0.032	0.045	0.022	0.035
10/31/2010	0.055	0.048	0.046	0.027	0.044
11/30/2010	0.02	0.023	0.02	0.012	0.019
3/31/2011	0.018	0.034	0.014	0.026	0.023
4/30/2011	0.066	0.062	0.035	0.034	0.049
5/31/2011	0.09	0.066	0.046	0.043	0.061
6/30/2011	0.071	0.077	0.048	0.038	0.058
7/31/2011	0.202	0.125	0.097	0.09	0.128
8/31/2011	0.273	0.092	0.099	0.013	0.119
9/30/2011	0.022	0.034	0.025	0.016	0.024
3/31/2012	0.02	0.01	0.01	0.01	0.013
4/30/2012	0.045	0.028	0.035	0.01	0.029
5/31/2012	0.135	0.083	0.098	0.045	0.09
6/30/2012	0.04	0.045	0.038	0.033	0.039
7/31/2012	0.04	0.07	0.245	0.058	0.103
8/31/2012	0.113	0.113	0.103	0.065	0.098
9/30/2012	0.04	0.04	0.03	0.028	0.034
10/31/2012	0.035	0.01	0.023	0.018	0.021
3/31/2013	0.03	0.03	0.03	0.03	0.03
4/30/2013	0.075	0.14	0.09	0.03	0.084
5/31/2013	0.072	0.065	0.041	0.03	0.052

MonthYear	Station 1	Station 2	Station 6	Station 9	Lake Wide Annual Average
6/30/2013	0.062	0.062	0.044	0.022	0.047
7/31/2013	0.162	0.167	0.076	0.092	0.124
8/31/2013	0.108	0.116	0.119	0.083	0.106
9/30/2013	0.071	0.078	0.062	0.046	0.064
10/31/2013	0.041	0.05	0.019	0.02	0.033
11/30/2013	0.064	0.061	0.057	0.025	0.052
3/31/2014	0.093	0.04	0.03	0.015	0.044
4/30/2014	0.161	0.142	0.055	0.091	0.112
5/31/2014	0.058	0.068	0.043	0.027	0.049
6/30/2014	0.129	0.085	0.111	0.069	0.099
7/31/2014	0.204	0.214	0.122	0.128	0.167
8/31/2014	0.085	0.069	0.056	0.069	0.07
9/30/2014	0.029	0.015	0.015	0.015	0.019
10/31/2014	0.066	0.04	0.023	0.015	0.036
11/30/2014	0.125	0.135	0.12	0.015	0.099
3/31/2015	0.015	0.015	0.015	0.015	0.015
4/30/2015	0.063	0.015	0.015	0.015	0.027
5/31/2015	0.033	0.064	0.015	0.015	0.032
6/30/2015	0.115	0.101	0.054	0.026	0.074
7/31/2015	0.097	0.103	0.05	0.044	0.073
8/31/2015	0.015	0.024	0.015	0.015	0.017
9/30/2015	0.029	0.015	0.015	0.015	0.019
10/31/2015	0.019	0.021	0.025	0.015	0.02
11/30/2015	0.015	0.015	0.015	0.015	0.015
4/30/2016	0.028	0.015	0.015	0.015	0.018
5/31/2016	0.063	0.015	0.032	0.039	0.037
6/30/2016	0.09	0.08	0.075	0.034	0.07
7/31/2016	0.124	0.069	0.03	0.028	0.063
8/31/2016	0.041	0.049	0.026	0.015	0.033
9/30/2016	0.015	0.015	0.015	0.015	0.015
10/31/2016	0.148	0.1	0.073	0.021	0.085
11/30/2016	0.215	0.23	0.11	0.048	0.151
3/31/2017	0.027	0.015	0.015	0.015	0.018
4/30/2017	0.036	0.03	0.015	0.015	0.024
5/31/2017	0.128	0.146	0.141	0.037	0.113
6/30/2017	0.11	0.103	0.09	0.039	0.085
7/31/2017	0.191	0.1	0.036	0.031	0.089
8/31/2017	0.085	0.102	0.049	0.024	0.065
9/30/2017	0.038	0.039	0.024	0.015	0.029
10/31/2017	0.042	0.041	0.039	0.032	0.038
11/30/2017	0.015	0.015	0.038	0.037	0.026
4/30/2018	0.023	0.027	0.02	0.028	0.024
5/31/2018	0.073	0.075	0.044	0.025	0.054
6/30/2018	0.073	0.06	0.026	0.028	0.046
7/31/2018	0.111	0.136	0.038	0.03	0.079
8/31/2018	0.106	0.065	0.036	0.021	0.057

MonthYear	Station 1	Station 2	Station 6	Station 9	Lake Wide Annual Average
9/30/2018	0.036	0.015	0.024	0.015	0.022
10/31/2018	0.083	0.015	0.015	0.015	0.032
11/30/2018	0.015	0.015	0.015	0.015	0.015
3/20/2019	0.015	0.015	0.133	0.015	0.044
4/11/2019	0.102	0.118	0.1	0.135	0.114
5/15/2019	0.184	0.165	0.143	0.041	0.133
6/13/2019	0.217	0.214	0.149	0.052	0.158
7/11/2019	0.172	0.155	0.147	0.106	0.145
8/8/2019	0.075	0.091	0.052	0.059	0.069
9/5/2019	0.062	0.045	0.039	0.049	0.049
10/29/2019	0.044	0.042	0.04	0.041	0.042

Constituent: Hardness as CaCO₃

Nutrient TMDL Data

Appendix E - Big Bear Lake Ammonia and Hardness Calculations

For this analysis, the lake-wide annual average was estimated by averaging the four station annual averages consistent with the Nutrient TMDL approach, which consist of averaging the photic and bottom samples for each sampling date.

	Station 1	Station 2	Station 6	Station 9	Lake Wide Annual Average
Min	124	126	127	131	128
Max	200	193	193	200	191
Average	161	161	164	164	163
Median	160	163	165	164	163

MonthYear	Station 1	Station 2	Station 6	Station 9	Lake Wide Annual Average
5/1/2009	160	164	164	163	163
6/30/2009	161	163	159	162	161
7/31/2009	164	164	167	164	165
8/31/2009	168	167	164	160	165
9/30/2009	167	168	167	164	166
10/31/2009	172	168	175	175	173
11/30/2009	170	170	171	172	170
6/30/2010	146	145	145	149	146
7/31/2010	151	153	162	159	156
8/31/2010	154	151	149	148	150
9/30/2010	150	152	149	150	150
10/31/2010	149	149	149	150	149
11/30/2010	149	149	149	150	149
3/31/2011	131	131	130	133	131
4/30/2011	124	127	130	133	129
5/31/2011	127	126	127	131	128
6/30/2011	129	131	132	132	131
7/31/2011	132	130	131	131	131
8/31/2011	135	134	134	135	134
9/30/2011	137	136	138	136	137
3/31/2012	145	147	147	147	147
4/30/2012	142	145	146	148	145
5/31/2012	146	145	145	147	146
6/30/2012	151	148	150	146	149
7/31/2012	158	156	155	152	155
8/31/2012	148	146	147	145	146
3/31/2013	143	140	150	155	147
4/30/2013	143	140	150	155	147
5/31/2013	150	160	158	150	154
6/30/2013	155	158	153	155	155

MonthYear	Station 1	Station 2	Station	Lake Wide Annual Average	
7/31/2013	160	163	158	158	159
8/31/2013	153	155	165	155	157
9/30/2013	156	158	160	155	157
10/31/2013	153	153	155	153	153
11/30/2013	153	150	165	160	157
3/31/2014	180	175	170	175	175
4/30/2014	160	160	165	163	162
5/31/2014	160	163	160	165	162
6/30/2014	168	165	170	173	169
7/31/2014	165	165	165	163	164
8/31/2014	168	170	175	175	172
9/30/2014	175	175	185	175	178
10/31/2014	170	170	175	178	173
11/30/2014	170	170	175	175	173
3/31/2015	160	160	160	175	164
4/30/2015	175	175	180	180	178
5/31/2015	173	170	168	173	171
6/30/2015	185	185	190	180	185
7/31/2015	188	190	193	193	191
8/31/2015	173	178	183	178	178
9/30/2015	185	178	185	183	183
10/31/2015	185	185	188	190	187
11/30/2015	200	185	185	190	190
4/30/2016	170	173	180	180	176
5/31/2016	175	175	180	180	178
6/30/2016	190	193	188	180	188
7/31/2016	180	185	183	188	184
8/31/2016	178	188	188	183	184
9/30/2016	190	185	190	180	186
10/31/2016	175	178	173	178	176
11/30/2016	180	175	180	180	179
3/31/2017	150	150	160	165	156
4/30/2017	160	160	165	168	163
5/31/2017	150	158	163	165	159
6/30/2017	165	163	170	170	167
7/31/2017	160	160	163	160	161
8/31/2017	173	173	175	175	174
9/30/2017	180	178	170	178	176
10/31/2017	175	173	180	178	176
11/30/2017	175	175	180	175	176
4/30/2018	178	180	183	190	183
5/31/2018	183	185	188	183	184
6/30/2018	190	183	183	180	184
7/31/2018	190	188	185	185	187
8/31/2018	180	180	180	170	178
9/30/2018	175	180	178	180	178

MonthYear	Station 1	Station 2	Station	Lake Wide Annual Average
10/31/2018	190	180	180	185
11/30/2018	180	185	190	200
3/20/2019	130	130	130	140
4/11/2019	135	138	140	143
5/15/2019	135	140	140	148
6/13/2019	140	143	145	150
7/11/2019	140	143	155	155
8/8/2019	145	143	148	148
9/5/2019	150	153	150	158
10/29/2019	150	150	150	150

Big Bear Area Regional Wastewater Agency

Replenish Big Bear

Antidegradation Analysis for Proposed Discharges to Stanfield Marsh/Big Bear Lake and Shay Pond

APPENDIX F: BORON MASS BALANCE ANALYSIS WITH LAKE DISCHARGE

Due to the limited amount of water quality data available, a simple spreadsheet model was completed to evaluate the contribution of the Lake discharge to boron concentrations in the Lake over time. See Section 5.3.2 of the Antidegradation Analysis for equations used.

Year	Lake Storage (AF)		Inflows (AF)		Outflows			Boron (mg/L)			Mass boron (pounds)				Lake at End		
Year	Watermaster	Adjusted Storage	Natural Inflows	BBARWA Discharge	Evaporation	Releases + Withdrawals + Leakage	Additional Releases	Lake	Inflow	Discharge	Lake	Inflow	Discharge	Releases	Mass	Volume (AF)	Concentration (mg/L)
1	36,009	36,009	7,112	2210	8,876	868	0	0.000	0.000	0.110	0	0	662	0	662	35,587	0.007
2	33,377	35,587	41,114	2210	12,112	999	0	0.000	0.000	0.110	0	0	662	0	662	65,800	0.004
3	61,380	65,800	25,447	2210	11,630	11,253	0	0.004	0.000	0.110	662	0	662	113	1,211	70,574	0.006
4	63,944	70,574	42,459	2210	11,883	31,045	0	0.006	0.000	0.110	1,212	0	662	533	1,341	72,315	0.007
5	63,475	72,315	6,568	2210	11,990	2,358	0	0.007	0.000	0.110	1,342	0	662	44	1,960	66,745	0.011
6	55,695	66,745	25,218	2210	11,125	2,951	6,777	0.011	0.000	0.110	1,962	0	662	256	2,368	73,320	0.012
7	66,837	73,320	35,142	2210	12,007	25,266	79	0.012	0.000	0.110	2,370	0	662	819	2,213	73,320	0.011
8	64,705	73,320	10,832	2210	11,710	2,524	0	0.011	0.000	0.110	2,215	0	662	76	2,801	72,128	0.014
9	61,303	72,128	9,396	2210	11,518	2,636	0	0.014	0.000	0.110	2,803	0	662	102	3,363	69,580	0.018
10	56,550	69,580	13,812	2210	11,515	1,488	0	0.018	0.000	0.110	3,366	0	662	72	3,956	72,599	0.020
11	57,359	72,599	8,005	2210	10,819	266	0	0.020	0.000	0.110	3,960	0	662	15	4,607	71,729	0.024
12	54,279	71,729	4,551	2210	11,161	355	0	0.024	0.000	0.110	4,612	0	662	23	5,251	66,974	0.029
13	47,314	66,974	4,967	2210	11,092	355	0	0.029	0.000	0.110	5,256	0	662	28	5,890	62,704	0.035
14	40,834	62,704	4,855	2210	9,542	457	0	0.035	0.000	0.110	5,896	0	662	43	6,515	59,770	0.040
15	35,690	59,770	11,658	2210	9,235	565	0	0.040	0.000	0.110	6,521	0	662	62	7,121	63,838	0.041
16	37,548	63,838	15,543	2210	10,714	489	0	0.041	0.000	0.110	7,129	0	662	55	7,736	70,388	0.040
17	41,887	70,388	48,613	2210	11,716	12,382	23,793	0.040	0.000	0.110	7,743	0	662	3,587	4,818	73,320	0.024
18	66,402	73,320	11,015	2210	11,784	2,903	0	0.024	0.000	0.110	4,823	0	662	191	5,293	71,858	0.027
19	62,730	71,858	33,340	2210	11,861	19,225	3,002	0.027	0.000	0.110	5,299	0	662	1,606	4,355	73,320	0.022
20	64,984	73,320	13,119	2210	12,262	4,228	0	0.022	0.000	0.110	4,359	0	662	251	4,769	72,159	0.024
21	61,613	72,159	8,757	2210	11,456	1,015	0	0.024	0.000	0.110	4,774	0	662	67	5,369	70,655	0.028
22	57,899	70,655	34,629	2210	11,464	12,790	9,920	0.028	0.000	0.110	5,374	0	662	1,614	4,422	73,320	0.022
23	68,274	73,320	3,774	2210	12,473	1,269	0	0.022	0.000	0.110	4,426	0	662	77	5,011	65,562	0.028
24	58,306	65,562	6,930	2210	11,829	1,106	0	0.028	0.000	0.110	5,016	0	662	85	5,594	61,767	0.033
25	52,301	61,767	6,915	2210	11,299	1,094	0	0.033	0.000	0.110	5,599	0	662	99	6,162	58,499	0.039
26	46,822	58,499	1,717	2210	10,375	1,040	0	0.039	0.000	0.110	6,168	0	662	110	6,720	51,011	0.048
27	37,109	51,011	8,295	2210	9,382	1,073	0	0.048	0.000	0.110	6,727	0	662	141	7,247	51,061	0.052
28	34,948	51,061	8,404	2210	9,025	1,154	0	0.052	0.000	0.110	7,254	0	662	164	7,752	51,496	0.055
29	33,173	51,496	39,600	2210	11,525	745	7,716	0.055	0.000	0.110	7,760	0	662	1,101	7,321	73,320	0.037
30	60,503	73,320	17,564	2210	12,421	1,371	5,982	0.037	0.000	0.110	7,328	0	662	645	7,345	73,320	0.037
31	64,274	73,320	2,841	2210	11,921	1,445	0	0.037	0.000	0.110	7,352	0	662	145	7,869	65,005	0.045
32	53,748	65,005	14,182	2210	11,460	865	0	0.045	0.000	0.110	7,877	0	662	105	8,434	69,072	0.045
33	55,605	69,072	9,212	2210	11,233	1,154	0	0.045	0.000	0.110	8,443	0	662	141	8,963	68,107	0.048
34	52,431	68,107	32,959	2210	11,374	3,269	15,313	0.048	0.000	0.110	8,972	0	662	2,146	7,488	73,320	0.038
35	70,746	73,320	16,908	2210	12,028	8,649	0	0.038	0.000	0.110	7,496	0	662	884	7,273	71,761	0.037
36	66,977	71,761	8,175	2210	12,503	1,871	0	0.037	0.000	0.110	7,281	0	662	190	7,753	67,772	0.042
37	60,778	67,772	3,129	2210	11,645	2,168	0	0.042	0.000	0.110	7,761	0	662	248	8,174	59,298	0.051
38	50,094	59,298	5,776	2210	10,942	1,386	0	0.051	0.000	0.110	8,182	0	662	191	8,653	54,956	0.058
39	43,543	54,956	3,677	2210	9,709	2,033	0	0.058	0.000	0.110	8,662	0	662	320	9,003	49,101	0.067
40	35,478	49,101	7,027	2210	9,309	1,349	0	0.067	0.000	0.110	9,012	0	662	248	9,426	47,680	0.073
41	31,847	47,680	13,213	2210	9,777	1,077	0	0.073	0.000	0.110	9,436	0	662	213	9,884	52,249	0.070
42	34,206	52,249	4,818	2210	9,391	1,391	0	0.070	0.000	0.110	9,894	0	662	263	10,293	48,495	0.078

Year	Lake Storage (AF)		Inflows (AF)		Outflows			Boron (mg/L)			Mass boron (pounds)				Lake at End		
	Watermaster	Adjusted Storage	Natural Inflows	BBARWA Discharge	Evaporation	Releases + Withdrawals + Leakage	Additional Releases	Lake	Inflow	Discharge	Lake	Inflow	Discharge	Releases	Mass	Volume (AF)	Concentration (mg/L)
43	28,242	48,495	25,391	2210	10,079	954	0	0.078	0.000	0.110	10,303	0	662	203	10,762	65,063	0.061
44	42,590	65,063	7,945	2210	10,608	1,264	0	0.061	0.000	0.110	10,773	0	662	209	11,225	63,346	0.065